

WS-22 onderaanzicht

Jan Poortman PA3ESY

15-10-2013

LT + 12 Volt
Zenden

LT + 12 V

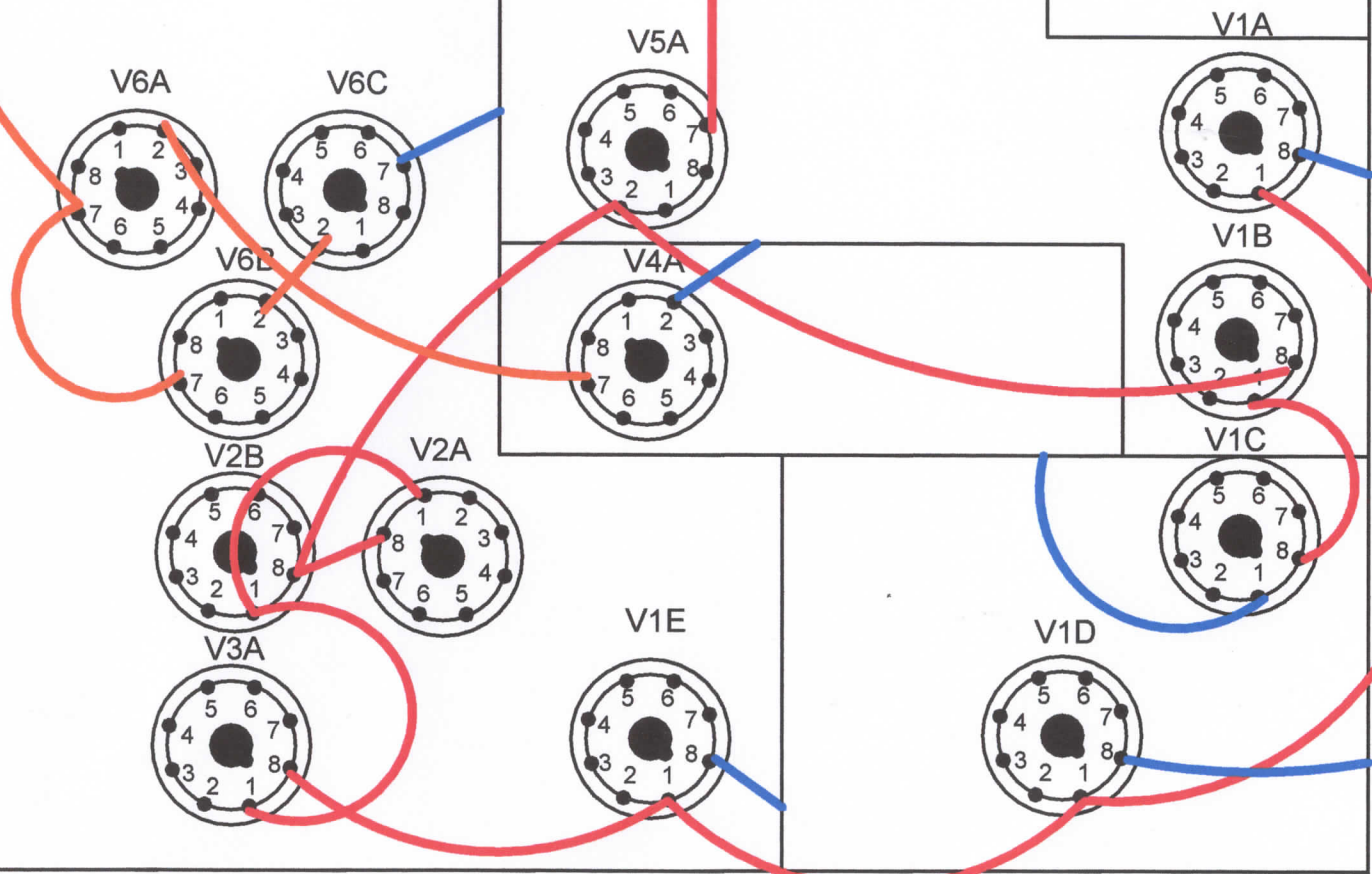

**WS-22 onderaanzicht
Filament**

Jan Poortman PA3ESY 15-10-2013

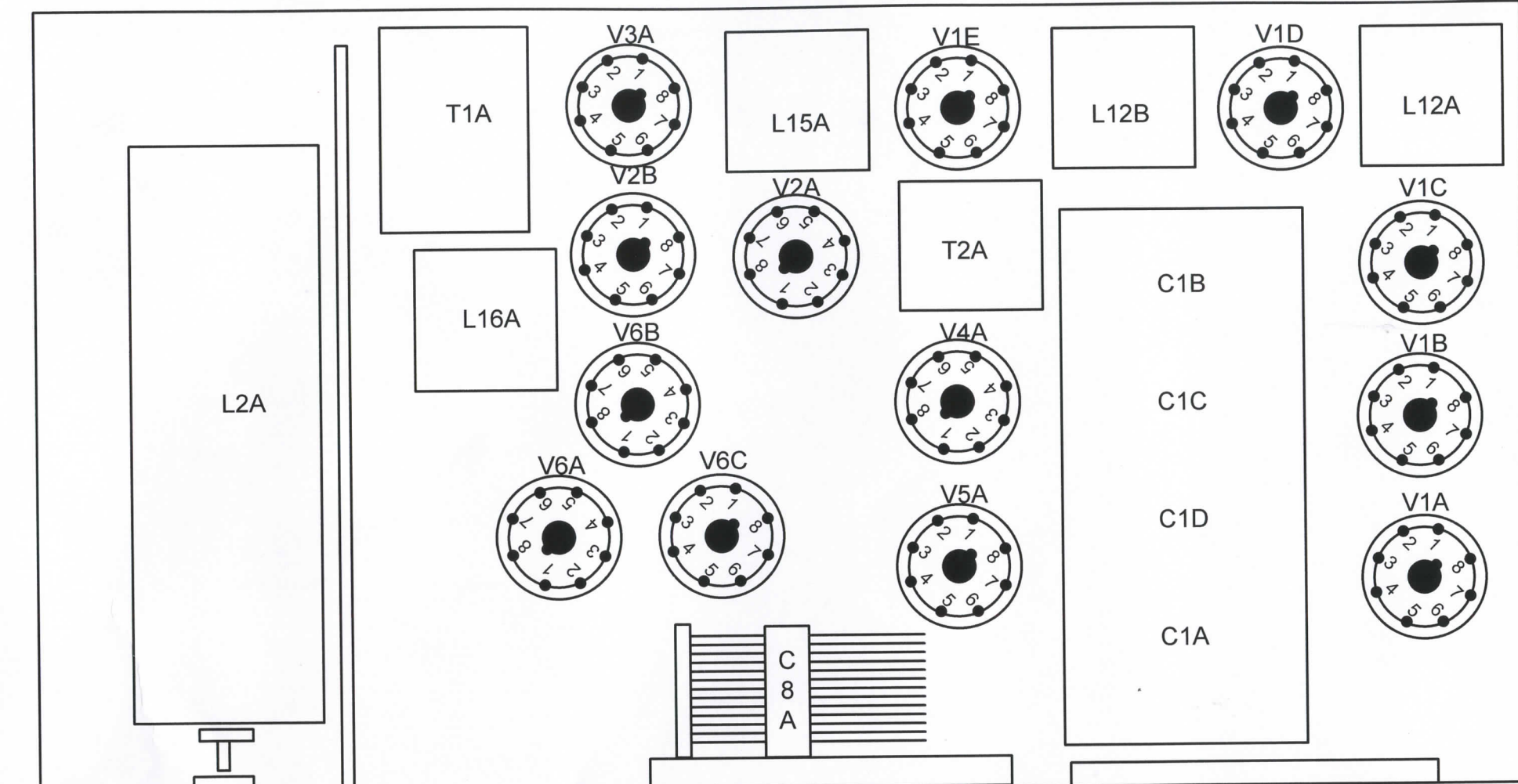

WS-22 bovenaanzicht
 Jan Poortman PA3ESY 15-10-2013

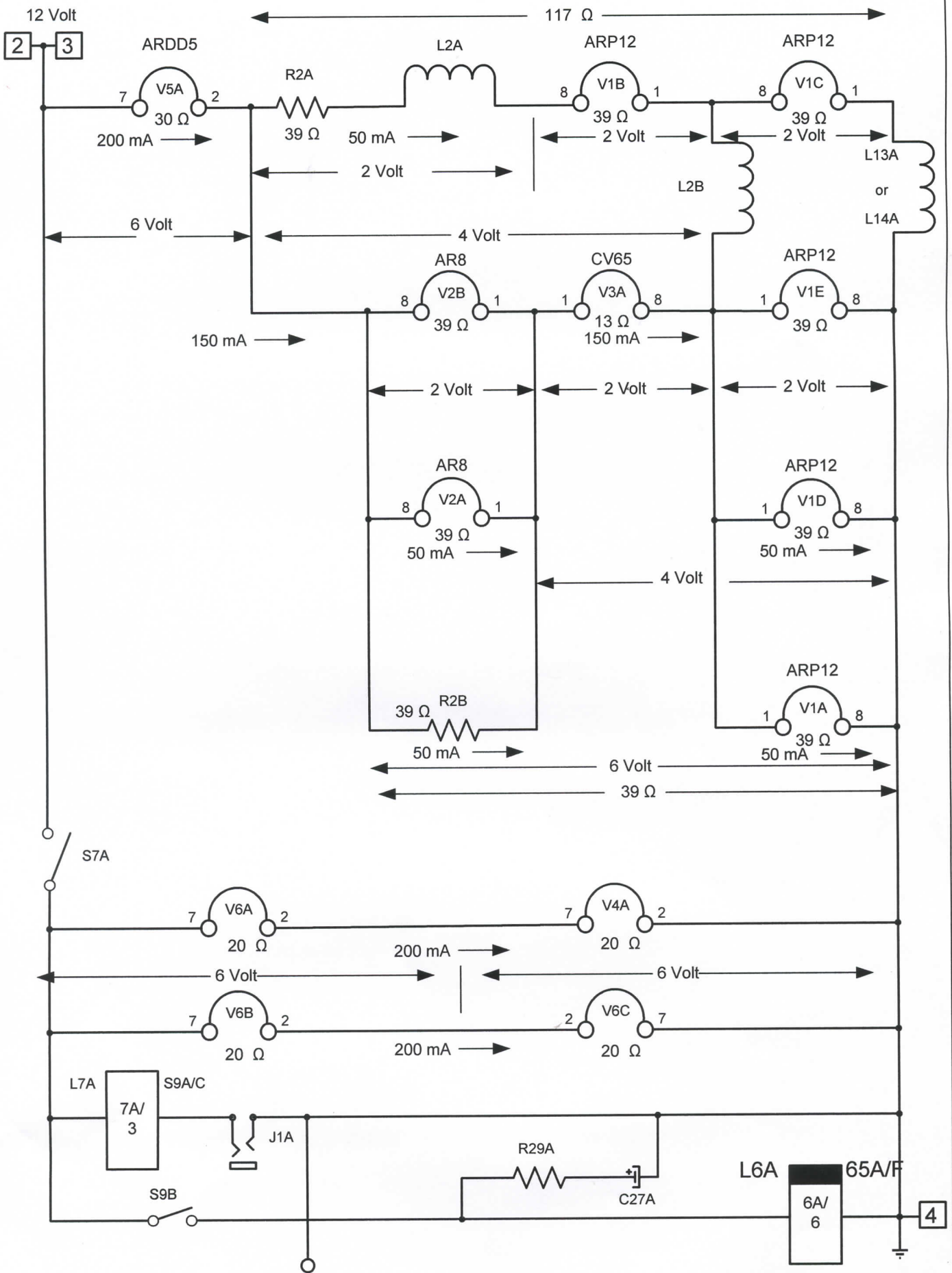

WS-22 Filament and Relay circuits

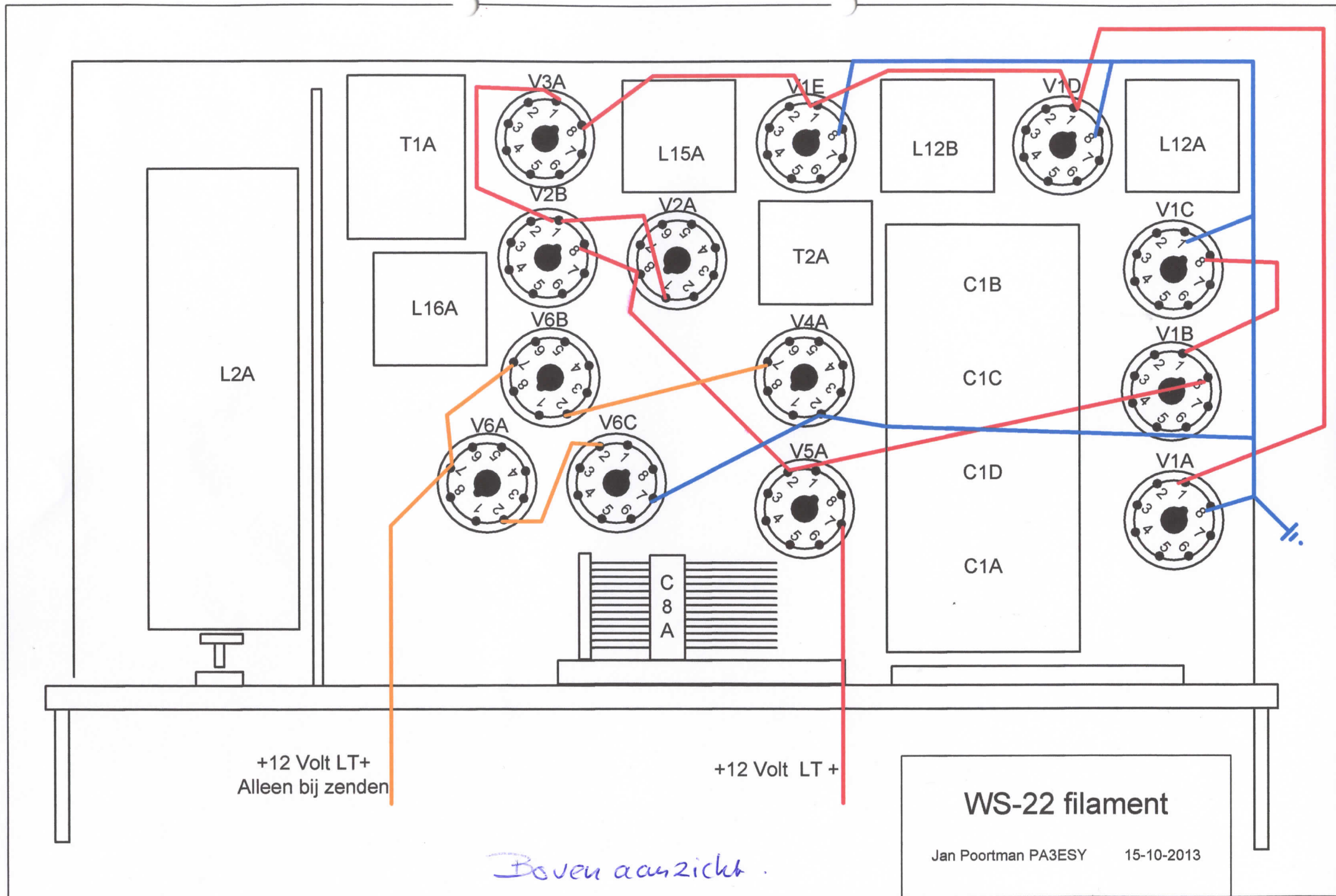

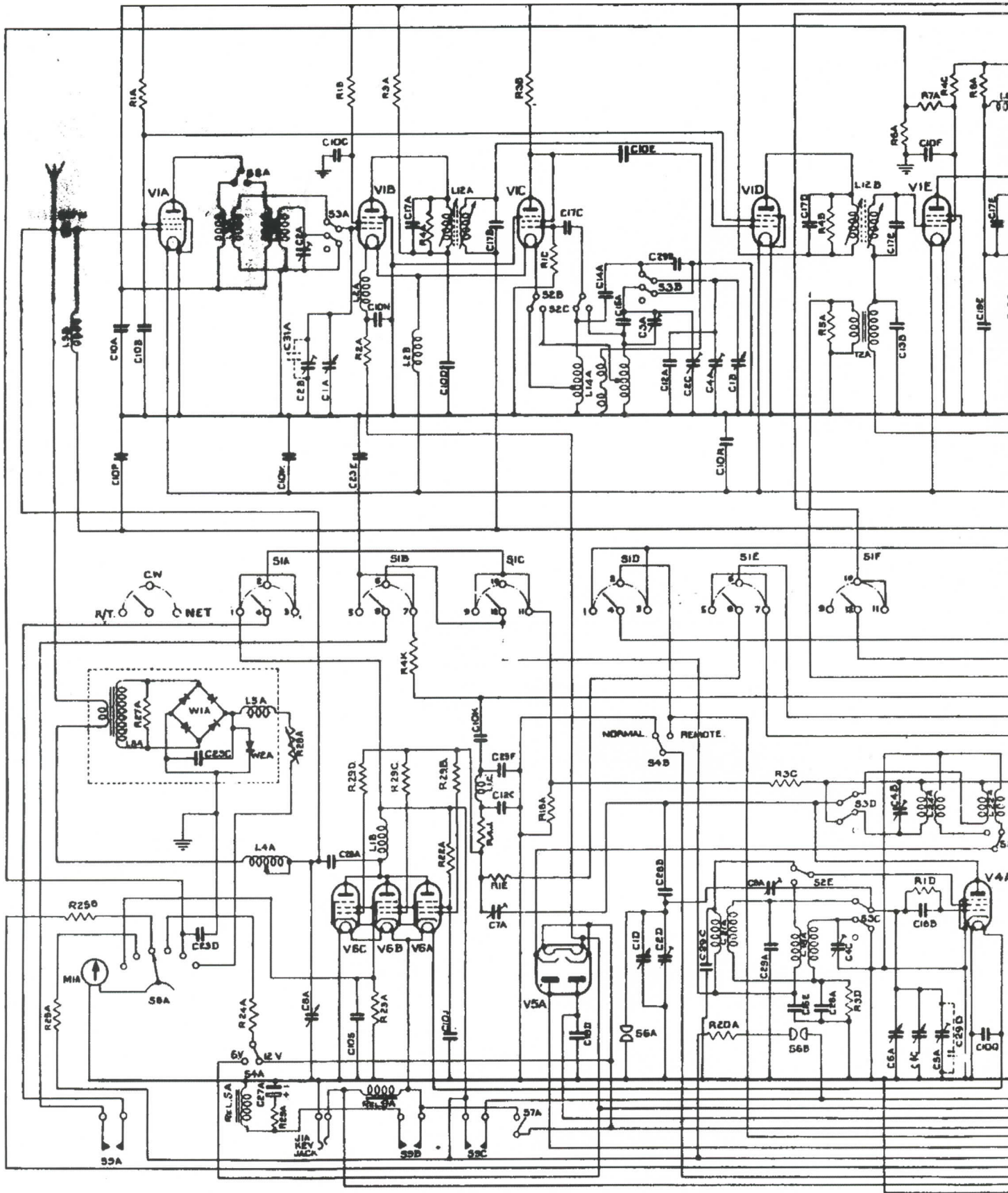

WIRELESS SETS,

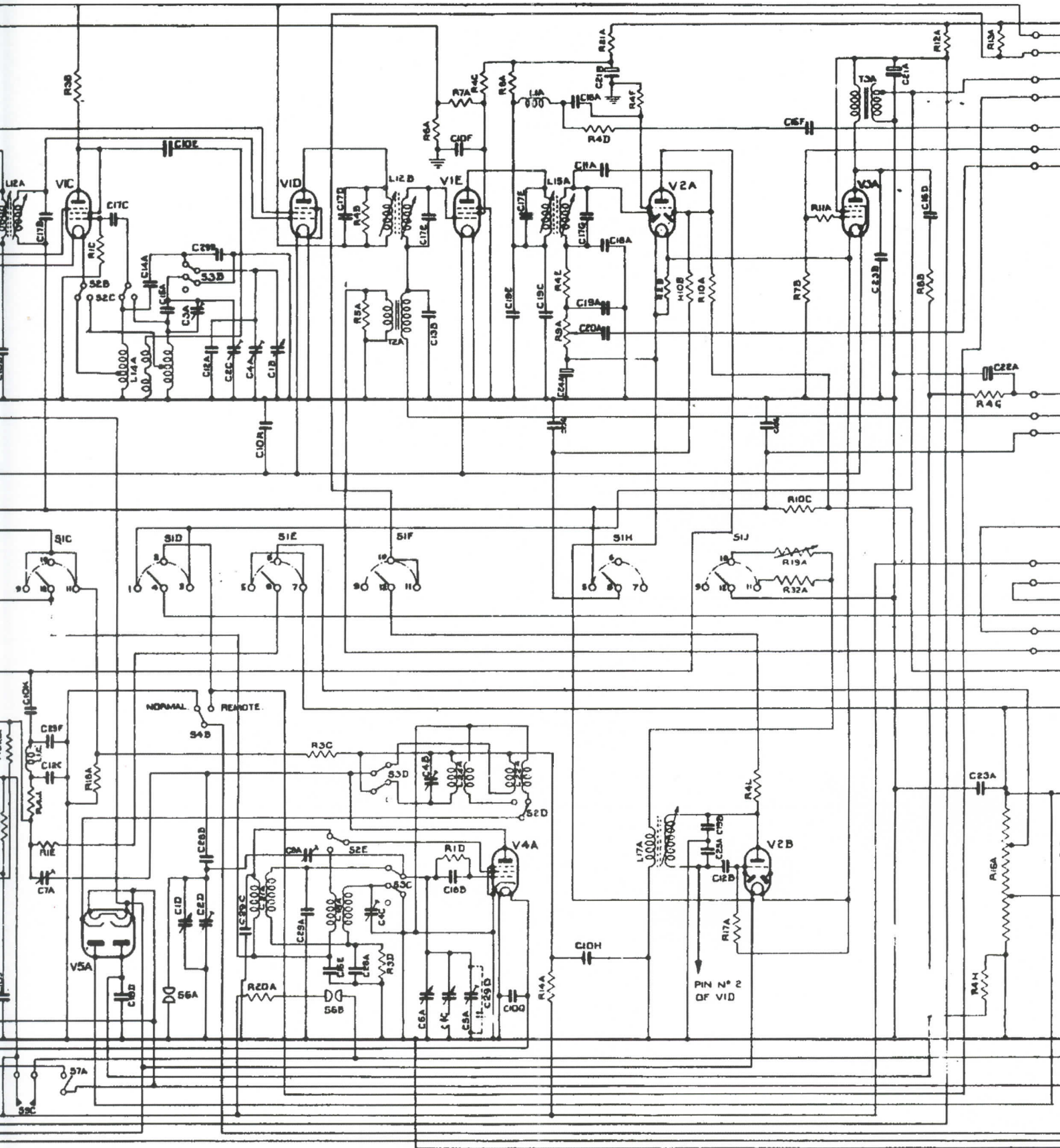

WIRELESS SETS, No.22. MK.I/I.

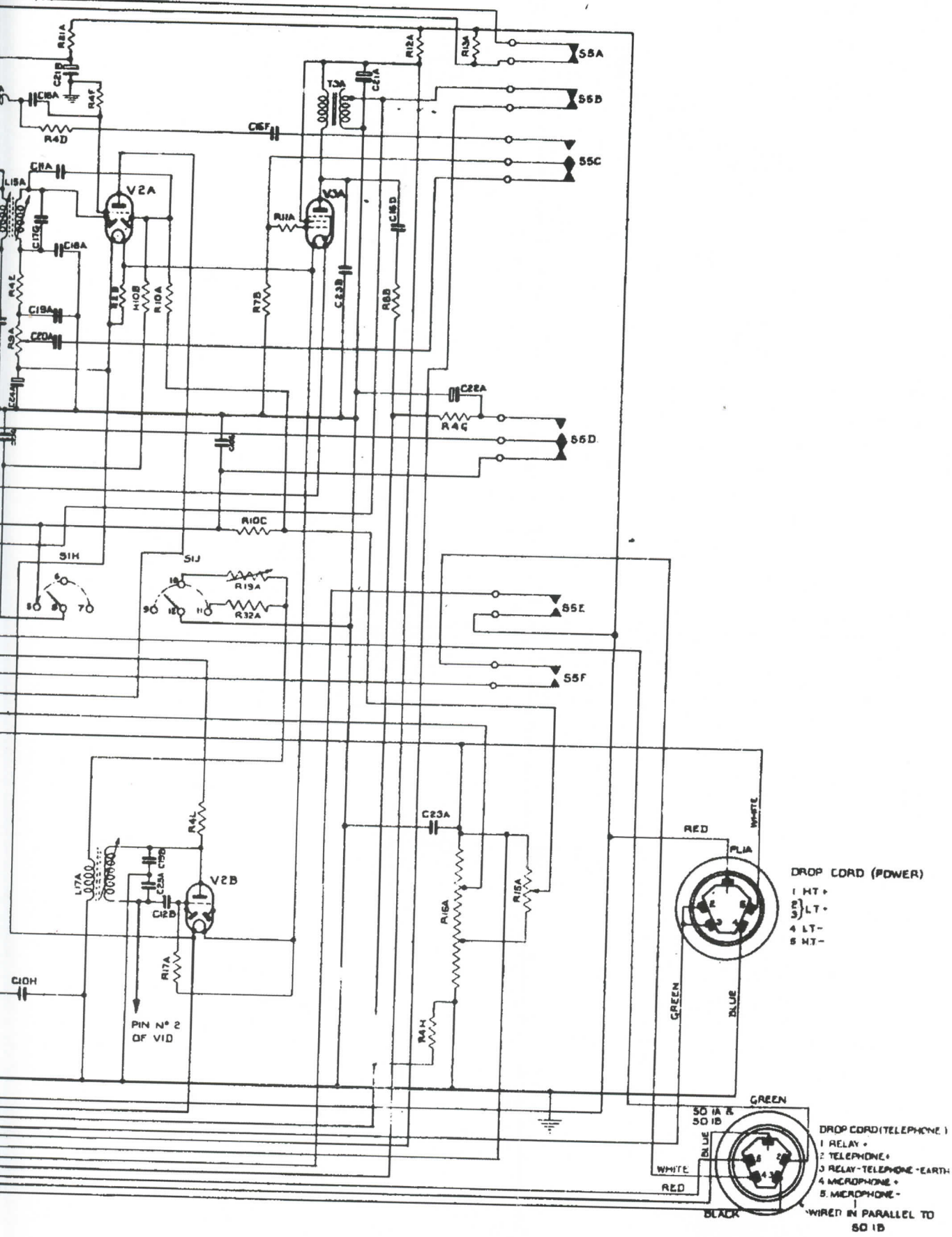

No.22. MK.I/I.

I.E.M.E. 5.6374 1551.

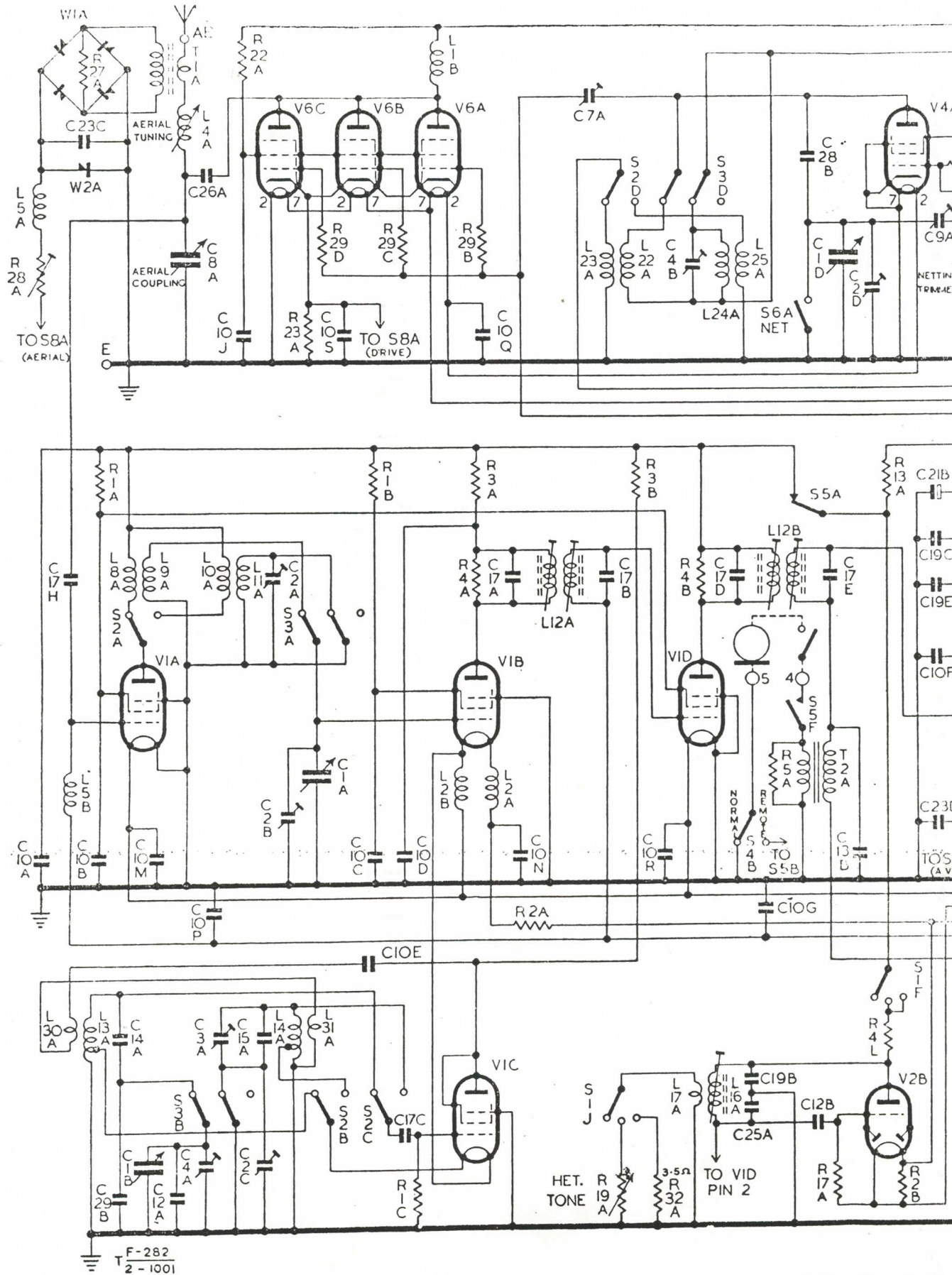

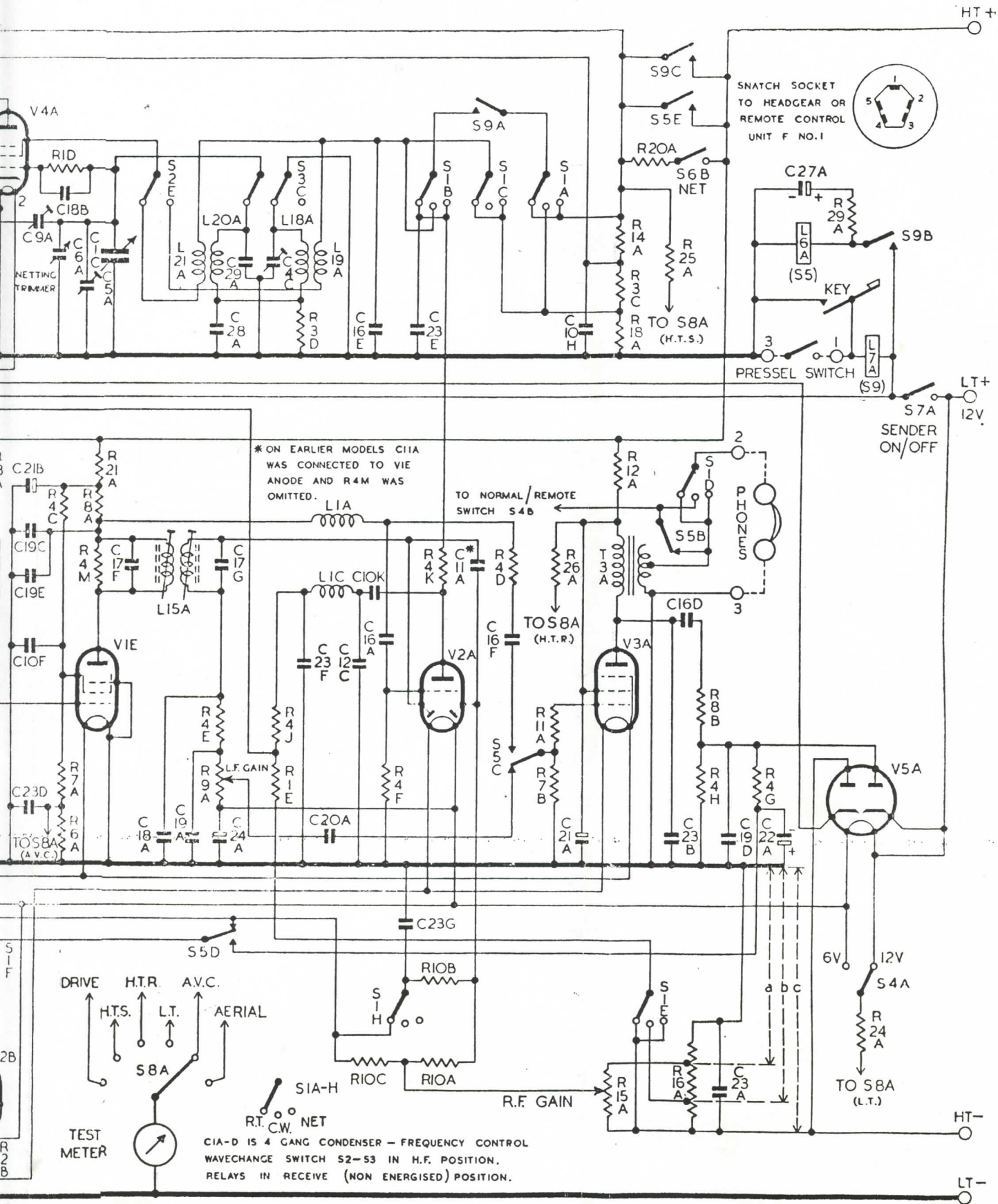

ME10/W-AN/5

Table 1001—Details of components (Figs. 1001 and 1003)

CONDENSERS

Circuit reference	Value	Tolerance	Rating	Type
C1A-D		Four section, variable		
C2A-D	3-30pF	Trimmer		Mica
C3A	150-600pF	Trimmer		Mica
C4A-C	1-15pF	Trimmer		Mica
C5A	3-50pF	Trimmer		Mica
C6A	2.8-10pF	Variable, netting trimmer		
C7A	4-8pF	Trimmer		Mica
C8A	540pF max.	Variable, aerial coupling		
C9A	1-7.5pF	Trimmer		Ceramic
C10A-S	0.1μF	±20%	350V	Paper
C11A	20pF	±20%		Silvered mica
C12A-C	30pF	±10%		Silvered mica
C13B	50pF	±2%		Silvered mica
C14A	1600pF	±2%		Silvered mica
C15A	1300pF	±2%		Silvered mica
C16A-F	0.01μF	±20%	350V	Paper
C17A-H	140pF	±2%		Silvered mica
C18A-B	0.0001μF	±15%		Mica
C19A-E	0.0005μF	±15%		Mica
C20A	0.002μF		450V	Paper
C21A-B	2μF		350V	Electrolytic
C22A	4μF		12V	Electrolytic
C23A-G	0.001μF	±25%		Mica
C24A	100μF		6V	Electrolytic
C25A	30pF	±2%		Silvered mica
C26A	0.004μF	±15%		Mica
C27A	200μF		12V	Electrolytic
C28A-B	0.005μF	±5%		Silvered mica
C29A-B	10pF	±10%		Silvered mica
C30A	0.005μF		450V	Paper
C32A	0.005μF			Mica
C33A-C	0.1μF		450V	Paper
C34A	0.01μF		2,200V	Paper
C35A-C	8μF	±10%	500V	Electrolytic

RESISTORS

Circuit reference	Value	Tolerance	Type
R1A-E	47kΩ	±10%	Ceramic
R2A-B	39Ω	±5%	Ceramic
R3A-D	10kΩ	±10%	Ceramic
R4A-M	100kΩ	±20%	Ceramic
R5A	220Ω	±10%	Ceramic
R6A	3,300Ω	±10%	Ceramic
R7A-B	470kΩ	±20%	Ceramic
R8A-B	22kΩ	±10%	Carbon
R9A	1MΩ		L.F. gain control
R10A-C	1MΩ	±20%	Ceramic
R11A	15kΩ	±10%	Ceramic
R12A	47kΩ	±10%	Carbon
R13A	20kΩ	±10%	Wire-wound
R14A	4.7kΩ	±10%	Carbon
R15A	100kΩ		R.F. gain control
R16A	860Ω		Wire-wound
R17A	22kΩ	±10%	Ceramic
R18A	39kΩ	±10%	Carbon
R19A	6Ω		Het. tone control
R20A	39kΩ	±10%	Carbon
R21A	68kΩ	±10%	Carbon
R22A	1,500Ω	±10%	Carbon
R23A	2.5Ω	±5%	Wire-wound
R24A	29.5kΩ	±2%	Carbon
R25A	1.2MΩ	±5%	Carbon
R26A	1.2MΩ	±5%	Carbon
R27A	33Ω	±10%	Ceramic
R28A	550Ω		Semi-adjustable car.
R29A-D	10Ω	±5%	Wire-wound
R30A	22Ω	±20%	Carbon
R31A-B	270Ω	±10%	Carbon

Circuit reference	INDUCTORS
L1A-C	R.F. choke
L2A-B	R.F. choke (filament)
L3A	Modulation choke
L4A	Aerial tuning
L5A-B	Aerial trans. filter choke
L6A	Slugged relay energizing coil
L7A	High-speed relay energizing coil (keying)
L8A	Receiver anode coil, H.F. coupling
L9A	Receiver anode coil H.F. tuned
L10A	Receiver anode coil L.F. coupling
L11A	Receiver anode coil L.F. tuned
L12A-B	1st and 2nd I.F. transformers
L13A	Receiver oscillator coil H.F. tuned
L14A	Receiver oscillator coil L.F. tuned
L15A	3rd I.F. transformer
L16A	Beat oscillator coil tuned
L17A	Beat oscillator coil tuned
L18A	M.O. L.F. coil tuned
L19A	M.O. L.F. coil coupler
L20A	M.O. H.F. coil tuned
L21A	M.O. H.F. coil coupler
L22A	Drive H.F. coil tuned
L23A	Drive H.F. coil coupler
L24A	Drive L.F. coil tuned
L25A	Drive L.F. coil coupler
L26A-B	L.T. filter chokes
L27A	Vibrator energizing coil
L28A	Swinger choke
L29A	Smoothing choke
L30A	Receiver oscillator coil H.F. coupler
L31A	Receiver oscillator coil L.F. coupler
Circuit reference	MISCELLANEOUS
T1A	Aerial meter transformer
T2A	Microphone transformer
T3A	Output transformer
T4A	Vibrator transformer
S1A-J	R/T—C.W.—M.C.W. System switch
S2A-E	Wave-change switching, S.P.D.T.
S3A-D	Wave-change switching, S.P.D.T. (earth contact)
S4A	L.T. test switch, S.P.D.T.
S5A-F	Slugged relay
S6A-B	Netting switch
S7A	Sender on/off, S.P.S.T.
S8A	Meter switch
S9A-C	High-speed relay
S10A-B	On/off switch
S4B	Remote/normal switch
F1A	Fuse (34 S.W.G. Cu. wire)
V1A-E	ARP12, variable-mu R.F. pentode
V2A-B	AR8, double-diode-triode
V3A	CV65, output pentode
V4A	ARP34, variable-mu R.F. pentode
V5A	ARDD5, double-diode
V6A-C	VT52, L.F. pentode
PL1A	Power input plug (snatch)
So1A-B	Snatch sockets (headgear)
So2A	Inspection lamp socket
J1A	Key jacks
W1A	Bridge rectifier (metal)
W2A	Half-wave rectifier (metal)
W3A-D	Selenium rectifiers (power supply)
PIA	Indicator lamps

Table 1001—Details of components (Figs. 1001 and 1003)