

Ca

UNCLASSIFIED

NAVSHIPS 93053

0967-063-2010
Formerly 0280-446-4100

~~XXXXXXXXXXXXXXXXXXXX~~
~~XXXXXXXXXXXX~~

TECHNICAL MANUAL

FOR

RADIO RECEIVER R-390A/URR

VOLUME I OF III

~~XXXXXXXXXXXXXXXXXXXX~~
~~XXXXXXXXXXXX~~

c/c

REPRINTED W/T-1 AUG 1963
W/T-1(A) NOV 1964
W/T-4 NOV 1966



BUREAU OF SHIPS · NAVY DEPARTMENT · WASHINGTON 25, D.C.

UNCLASSIFIED

WARNING

DANGEROUS VOLTAGES EXIST IN THIS EQUIPMENT

Be careful when working on the 240-volt power supply and the circuits connected to it, or on the 115/230-volt ac line connections. Before connecting the receiver to an ac source, be sure that the chassis is connected to the same ground as the ac source.

DON'T TAKE CHANCES!

ELECTRONICS FIELD CHANGE BULLETIN
NAVAL SHIP ENGINEERING CENTER, NAVY DEPARTMENT
WASHINGTON, D. C.

6-R390A/URR

INTERNAL HEAT REDUCTION
FSN N5820-937-0141

TYPE (I), CLASS (A)
ESTIMATED MAN HOURS (2)

OPERATIONAL CHANGE ()
NON-OPERATIONAL CHANGE (X)

Prepared by

NAVAL SHIP ENGINEERING CENTER, NORFOLK DIVISION
(ELECTRONICS MAINTENANCE ENGINEERING CENTER)
U. S. NAVAL STATION
NORFOLK, VIRGINIA 23511

AUTHORIZATION NOTICE: Forces afloat shall accomplish this field change at the earliest opportunity on ship-installed equipment without reference to the Bureau of Ships.

EQUIPMENT AFFECTED: This field change applies to all shipboard installed R390A/URR equipments.

PURPOSE: The purpose of this field change is to reduce internal heating.

PREVIOUS FIELD CHANGES: No previous field changes need be accomplished.

EFFECT ON NOMENCLATURE: None

IDENTIFICATION OF ACCOMPLISHMENT: The accomplishment of this field change may be identified by: (1) The two rectifier tubes 26Z5W have been removed from their sockets; (2) New type heat dissipating tube shields have been installed on all tubes.

SHIPYARD TECHNICAL LIBRARY
COE Z 246P
PEARL HARBOR NAVAL SHIPYARD
26 NOV 1966

MATERIAL REQUIRED:

Supplied with Field Change Kit

Item	Ref. Desig.	Quantity	Description
	CR801 & CR802	2 ea.	Silicon Diode - 1N561, 9N5960-829-0728
2		13 ea.	Tube Shield, 7 pin medium 9N5960-686-8085
3		7 ea.	Tube Shield, 9 pin medium 9N5960-686-8087
4		2 ea.	Tube Shield, 7 pin short 9N5960-686-8119
5		1 ea.	Tube Shield, 9 pin long 9N5960-752-5857
6		1 ea.	Tube Shield, 7 pin long 9N5960-729-8150
7		2 ea.	Field Change Bulletin NAVSHIPS
8		2 ea.	Temporary Corrections to NAVSHIPS 93053, Technical Manual for Receiver R390A/URR

Required by Installing Activity

1		1 ea.	NAVSHIPS 93053 Technical Manual for Radio Receiver R390A/URR
---	--	-------	--

TOOLS REQUIRED:

Screwdriver, 6 inch common
 Screwdriver, Phillips head, 6 inch
 Diagonal Pliers, 6 inch
 Longnose Pliers, 6 inch
 Soldering Iron or Gun, 60-100 watts
 Solder
 AN/USM-116 or equivalent

PROCEDURE: (Refer to NAVSHIPS 93053)

NOTE: OBSERVE SAFETY PRECAUTIONS AT ALL TIMES, ALWAYS INSURE THAT THE EQUIPMENT IS PROPERLY GROUNDED, WHENEVER IT IS ENERGIZED.

1. De-energize the receiver at its power source.
2. Disconnect all wires and cables from the receiver.
3. Remove the receiver from its cabinet or rack and place upon a suitable workbench.

CAUTION: SEE "E1B 895" BULLETIN (DROPPING RESISTOR (+B LINE) INSTALLATION)
A. Installation of the Silicon Diodes 1N561 in the Receiver Power Supply:

1. Place the receiver on the workbench bottom up.
2. Remove the top and bottom dust covers if installed.
3. Remove the connector P111 from the power supply assembly.
4. With the Phillips head screwdriver, loosen the six greenheaded captive screws that secure the subchassis to the main frame of the receiver.
5. Carefully withdraw the subassembly from the receiver. Be careful not to drop it - it is heavy!
6. Remove the two rectifier tubes (26Z5W) from their sockets.
7. Place the power supply assembly bottom up, so that the socket connections are accessible. (See fig. 54, page 78, NAVSHIPS 93053).

CAUTION: USE CARE WHEN SOLDERING TO PREVENT THE HEAT FROM DAMAGING THE DIODES. UTILIZE HEAT SHUNTS WHEN SOLDERING.

8. Shape, cut leads, install, and solder the two 1N561 silicon diodes, item 1, as follows:
 - a. One diode between pins 1 and 4 of socket XV801, connecting the cathode lead of the diode to pin 4.
 - b. The remaining diode between pins 1 and 4 of socket XV802, connecting the cathode lead of the diode to pin 4.
9. Re-install the power supply in the following manner:
 - a. Carefully lower the power supply sub-chassis into the receiver, be careful not to drop it on the bench or into the receiver.
 - b. Engage the six green-headed captive screws that secure the power supply sub-chassis into the receiver. Tighten each of the six captive screws.

Reconnect the plug P111.

10. Temporarily apply power to the receiver.

11. With the AN/USM-116 adjusted to read +150 volts dc. Connect the common test lead to the receiver chassis and connect the other lead to the test jack E607. A reading of +148 to +152 v dc will be obtained which indicates proper operation of the power supply. If this voltage reading is not obtained, it indicates improper installation or a defective diode. Correct as required. If the test of the power supply is satisfactory, remove the test leads and remove the temporary power from the receiver.

12. Remove all the presently installed tube shields if they are not of the new heat dissipating type, MS-24333. Install the shields supplied in this kit on the sockets as follows:

<u>Item</u>	<u>Qty.</u>	<u>TYPE</u>	<u>SIZE</u>	<u>SOCKET NUMBERS</u>
2	13 ea.	MS-24233-2	7 Pin Med.	XV201, XV202, XV203, XV204, XV501, XV502, XV503, XV504, XV505, XV508, XV603, XV604, XV701
3	7 ea.	MS-24233-5	9 Pin Med.	XV205, XV206, XV506, XV507, XV509, XV601, XV602
4	2 ea.	MS-24233-1	7 Pin Short	XV207, XV401
5	1 ea.	MS-24233-6	9 Pin Long	XV510
6	1 ea.	MS-24233-3	7 Pin Long	XV605

13. Re-install the receiver in its cabinet or rack and reconnect all cables or wires.

14. Check operation of the receiver in accordance with applicable Maintenance Standards Book.

15. Retain removed rectifier tubes (26Z5W) and dust covers for possible future use. Discard all removed tube shields.

b. Write in CP09A1KB105K3; 1.0 uf, ± 10%, 100 vdcw.

Record this action on Record of Corrections Made page and adjacent to each pen and ink correction by inserting this EIB number (895).

**AN/FSH-7(V) Allowance Parts List #54925827--
Corrections to**

Refer to AN/FSH-7(V) Allowance Parts List (APL) #54925827 of April 1969 and make the following pen and ink corrections after completion of Field Change 18-AN/FSH-7(V).

NOTE

All corrections to be made in Section B

1. Page 4--1A2A15R7
 - a. Delete 279-3504 and add 279-1876.
2. Page 5--1A2A15A1R4
 - a. In the blank space after 1A2A15A1R3 add: "1 A 2A15A 1 R- 4 279-3503 P1272 0028 1 01"
3. Page 11--1A7A15C24
 - a. Delete 835-2175 and add 818-9760.

Adjacent to each pen and ink correction insert this EIB number (895).

⇒ R-390A/URR Receivers, Frequent Failures and Replacements of V603 and V604 AF Amplifier Tubes, 6AK6 Type--Maintenance Hint

It has been reported by CTMC David MYERS of NAVSECGRU, Edzell, Scotland that they are replacing a large number of 6AK6 tubes used in the V603 and V604 R-390A/URR receiver AF amplifier application. Upon investigation, they found that when Field Change #6 to an R-390A/URR was accomplished, plate voltage to these two tubes is increased by 20 to 35 VDC, depending on AC line input voltage. Tube specifications for 6AK6's stipulate that they should not be operated with plate voltages (plate to cathode) in excess of 180 VDC. R-390A/URR field change #6 is boosting the plate to cathode voltage to between 200 and 215 VDC. This is resulting in the development of internal tube shorts, which in turn, in some instances, also results in damage to each tube's respective cathode resistors.

In order to minimize downtime and the unnecessary use of repair time and parts, a

series B+ dropping resistor may be installed by activities which are experiencing this problem.

Refer to the 15 April 1970 issue of the R-390A/URR Technical Manual, NAVLEX 0967-063-2010, figure 5-13, sheet 2, zone B-7. The resistor will be located between terminal #5 of J619 and terminal #1 of L601 and may be installed as follows:

a. The following resistor types and values are recommended for this installation and should be obtained from supply, before starting the installation, if they are not on hand. One resistor is required for each receiver. Use a 200 ohm resistor if the AC line voltage is consistently maintained at 115 VAC; use a 220 ohm resistor if the line voltage will vary up to 120 and 125 VAC.

* RW31V221 220 ohms, 14 watts 9N5905-00-642-2542

* RW3FV201 200 ohms, 14 watts 9N5905-00-636-9919

RW68V221 220 ohms, 11 watts 9N5905-00-973-9157

RW68V201 200 ohms, 11 watts 9N5905-00-973-9225

* Requires the addition of hook-up wire pigtails to the resistor terminals.

b. Remove the AC power from the receiver at the main bulkhead switch.

c. Remove the receiver chassis from its cabinet or rack. Disconnect and tag as necessary the cables connected to the rear of the receiver.

d. Place the receiver chassis on its side on a flat work surface and remove the AF amplifier sub-chassis.

e. Unsolder and disconnect the single lead from L601 terminal #1. Check that the opposite end of the lead is connected to J619 terminal #5.

f. Cut the wiring harness ties as necessary to enable connection of the disconnected end of the lead to XC-606 spare terminal #2.

g. Install the resistor between L601-1 and XC-606-2. Prior to the resistor installation, position any leads in the area between L601 and XC-606 so that they will not contact the resistor, or be between the resistor and the chassis. Retie the leads as necessary and solder the connections.

h. Reconnect the AF sub-chassis to J619 and J620 so that the component side of the chassis is accessible; reapply AC line power to the receiver, and set the FUNCTION switch to AGC.

FOR OFFICIAL USE ONLY

i. Check the DC plate voltage between pins 5 and 7 at V603 and V604 tube sockets. — Depending on AC line input levels, B+ should be in the approximate range of 170 to 180 VDC.

j. After the resistor installation, the CARRIER meter and IF GAIN adjustments should be checked, and performed if found necessary, in accordance with the procedures in Chapter 6 of the technical manual.

k. Remove the AC power from the receiver and reinstall the AF amplifier sub-chassis in its respective mounting location; reconnect the cables at the rear of the receiver chassis, and reinstall the receiver in its cabinet or rack.

l. Reapply AC power to the receiver; return the receiver to the mode desired.

TA-790/U Microphone Element—Maintenance Hint

Several failures of Raonwell part number 113950 microphone element (part of TA-790/U telephone set) have been reported recently. The failures are due to broken wires internal to the element.

This article provides a procedure for repairing the element. Use of this procedure is recommended only in an emergency situation when a replacement microphone is not available.

The microphone element is a factory sealed unit. The seal must be broken in order to effect repair. Caution must be exercised in both breaking and restoring the seal.

Material Required:

Scotchweld Adhesive #1838 B/A or equivalent

#28 AWG Stranded Wire Cotton

Tools Required:

Screwdriver, flat, 1/8 inch blade

Soldering Iron, 25-30 watt

Solder, 60/40, Resin core

Test Equipment Required:

None

Procedure:

Proceed as follows:

NOTE

USE CAUTION WHEN SOLDERING TO
AVOID INTERNAL DAMAGE

1. Construct a jig to hold the microphone element during the disassembly and assembly operation.

2. Using a small screwdriver gently tap to puncture seal. Continue around the periphery of the element.

3. Cautiously separate black portion of microphone from red portion to expose broken wire.

4. Remove broken wire and replace with 2 inches of #28 AWG stranded wire.

5. Place a ball of cotton between the internal element and the case sufficient to preclude vibration of the element under normal conditions.

6. Place black portion of microphone over red portion in the original alignment.

7. Seal with sealant.

The first part of this maintenance hint is a result of an adopted suggestion by DAVID A. FRITZLER, ETN 3, USS SHREVEPORT (LPD 12) and the second part is a result of an adopted suggestion by JONATHAN P. WORLEY, ETNSN, USS VREELAND (DE-1068).

COUNTERMEASURES

Field Change 37-AN/FRA-54(V), 5-AN/FRA-54A(V), 22-AN/FLR-11(V), 5-AN/FLR-11A(V)—Removal of Storage Batteries and Power Selector Unit from OA-4414/F Time Code Distribution Group—Correction to EIB 886

The purpose of this article is to correct a discrepancy on subject field changes as printed in EIB 886 and to add one additional step.

Refer to EIB 886, page 3, Procedures: Delete Step 6. Write in "See EIB 895 for further steps."

Corrected Step 6 and additional Step 7 are as follows:

1. Step 6. Save P-14 from the removed interconnecting cables. Remove all wires from subject plug and perform the following:

a. Solder a jumper between pin 3 and pin 5 of P-14.

b. Solder a jumper between pin 1 and pin 4 of P-14.

c. Reinstall P-14 into J-14 of the O-1076/F.

2. Step 7. Restore equipment to operational condition.

All other items of this field change are correct.

Thanks to CTMCM William H. MAUER, CTMI Robert B. HANSHAW, CTMI William L. SILAS an

FOR OFFICIAL USE ONLY

TEMPORARY CHANGE T-4 to TECHNICAL MANUAL for Radio Receiver R-390A/URR NAVSHIPS 0967-063-2010 (formerly NAVSHIPS 93053).

This temporary change revised the manual to reflect the equipment changes made by Field Changes 4-R-390A/URR and 5-R-390A/URR which appeared in EIBs 655, 661 and 664.

When this change is included in the manual, the manual shall cover the equipment as though Field Changes 4-R-390A/URR and 5-R-390A/URR, NAVSHIPS 0967-063-2140 had been accomplished on the equipment. This change does not supersede any other changes or corrections.

Maintenance Support Activities shall make this change in the technical manual immediately but shall keep the superseded data intact for support of equipments that have not been modified.

1
Holders of equipment accompanied by technical manuals shall not make this change in the manual until accomplishment of the field changes referenced above.

Insert this temporary change in the manual immediately after the front cover and preceding the title page or prior changes or temporary corrections in effect. Make pen-and-ink changes in the manual as follows:

1. The following technical manual change material was originally published as part of Field Change 4-R-390A/URR which appeared in EIB 655, 661 and 664.

Figure 89, sheet 2: Delete wire between P120-11 and shielded ground 1/4 inch above P120-11. Change shielded ground connection into a test jack and at right, label "J904-Diode Load Test Jack."

Add the following notes on page 2:

NOTE 1: The AN/USM-116 Multimeter is to be used throughout this technical manual in lieu of the TS-505 Multimeter.

NOTE 2: The Impedance Adaptor MX-1487/URM-25D is to be used between RF Signal Generator and Receiver whenever alinement or adjustment of the RF or IF sections of the receiver are made.

2. The following technical manual change material was originally published as part of Field Change 5-R-390A/URR which appeared in EIBs 655, 661 and 664.

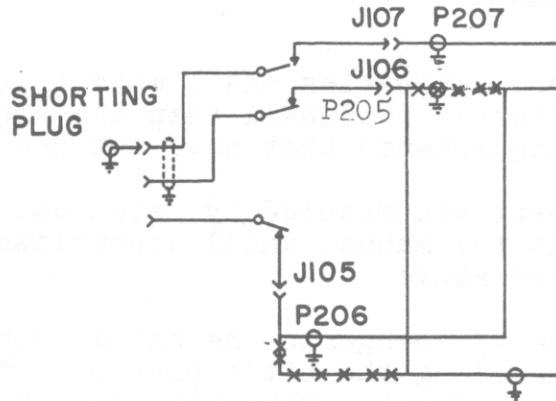

Figure 1. Correction to figure 89-1.

a. Volume 1, page 5 and Volume 2, page 11; add at bottom of page "Antenna input connections modified by Field Change 5, Shipboard installations use J103."

b. Volume 3, pages 7, 8, 169, and 171; add at left side of figure "Antenna input connections modified by Field Change 5, Shipboard installations use J103 (see figure 89-1."

c. In the following paragraphs, change "Balanced Antenna" to "Unbalanced Antenna": 48C, 107a thru 113a, 115b(1), 116a, 118a thru 121a, and 122F.

d. Page 91, step 11; delete "Balanced" from Test Connection column.

e. Add the following at the top left of figures 57 and 75 through 81: "Use J103 Antenna Jack in lieu of J104 for test on shipboard installations - Field Change 5."

f. Page 178, figure 89-1:

(1) Correct antenna input connections at upper left side of page as shown in figure 1 of this article.

(2) Delete "125 ohm Balanced" in J104 block at left of antenna input.

(3) Below antenna input wiring, write "Antenna input modified on shipboard installations by Field Change 5. Shipboard installations use J103."

The ordering number for this correction is 0967-063-2010.

Make the following pen and ink corrections to Technical Manual NAVSHIPS 93053.

<u>LOCATION</u>	<u>ACTION</u>
Page 6, para. 4-L Line 4	Change line to read "AC Power is rectified by CR801 and CR802"
Page 44, para. 28(a) Power Supply and Main Filter Circuits. Lines 8 and 9	Delete the following: "The plates of each rectifier (V801 and V802) are connected in parallel and ..."
Line 10	Delete "tubes" Insert "diodes"
Line 13	Delete "V801 and V802" Insert "CR801 and CR802"
Line 15	Delete "V801 and V802" Insert "CR801 and CR802"
Page 45, Fig. 28 Power Supply Schematic at tube sockets.	Delete "V801-26Z5W and V802-26Z5W" from schematic Insert "CR801, 1N561 and CR802, 1N561" Insert "Symbols for diodes with cathodes connected to pin 4 and plates to pin 1"
Page 58, para. 41(a) Lines 5 and 6	Delete "V801 and V802" Insert "CR801 and CR802"
Page 60, under B+ Short Circuit Tests First line, Isolating Procedure	Delete "Remove V801"
Second Line,	Correct to read: "XV801 and chassis"
Sixth Line	Delete "Remove V802"
Page 61, para. 42a(1) Open Circuits Lines 9 and 10	Delete reference to "V801 and V802"
Page 62, para. 42a(2)	Delete "IF Rectifiers V801 and V802 DO NOT LIGHT, THE TROUBLE IS WITH THE TUBES".
Page 62, para 42b(1) Short Circuits Lines 9 and 10	Delete "Tubes V801 and V802 in the power supply subchassis light and"

Page 64, para. 46
Troubleshooting Chart
Fig. 53, Power Supply Sub-
chassis under Procedure Step E.

Under Procedure Step F.

Under Procedure Step F,
last line

Page 78, Fig. 53
Power Supply, subchassis
Top View

Page 86, Fig. 63, Power
Supply Subchassis, Voltage
and Resistance Diagram

Page 169, Fig. 85, R390A/URR
Block Diagram
(in Block Rectifiers)

Page 178, Fig 89-(1) Main
Schematic, Power Supply
Subchassis

Delete "Remove V801 and V802"

Delete "Remove V801 and V802"

Correct to read:
"Pin 1 of XV801 and pin 1 of XV802"

Next to Symbols V801 and V802, insert
"Removed by FC 6"

Delete reference to "V801-V802, 26Z5W,
and insert "CR801-CR802, 1N561"

Delete reference to "V801, V802,
26Z5W"
Insert "CR801-CR802, 1N561"

Delete reference to "V801-V802-26Z5W"
Insert "CR801-CR802, 1N561"
Insert symbol for diode connected to
pin 1 and pin 4 with cathode connected
to pin 4 on sockets XV801 and XV802.

TEMPORARY CORRECTION T-1(A) TO TECHNICAL MANUAL FOR
RADIO RECEIVER R-390A/URR
NAVSHIPS 93053

This temporary correction revises the manual to reflect the equipment changes made by Field Change 3-R-390A/URR. The purpose of this field change is to alter the electrical access at the rear of the receiver from terminal boards to "AN" type connectors. If it becomes necessary to remove the receiver from its cabinet, it will be necessary only to unfasten connectors instead of the individual wires at the terminal boards. The field change applies to all shipboard R-390A/URR Receivers, all serial numbers.

Maintenance Support Activities shall make this correction in the technical manuals immediately but shall keep the superseded data intact for support of equipments that have not been modified.

Holders of equipment accompanied by technical manuals shall not make this correction in the manuals until accomplishment of the field change.

Make the following pen-and-ink corrections. Insert this temporary correction in the technical manuals immediately after the front cover.

<u>PAGE</u> <u>NO.</u>	<u>PARA & LINE</u> or <u>FIG & LOCATION</u>	<u>ACTION</u>
---------------------------	--	---------------

Volume I

11	Figure 7	Add: "This panel is now modified. See Figure 1 of T-1(A) to NAVSHIPS 93053."
----	----------	--

Volume II

9	Figure 5	Delete those parts of the illustration associated with:
---	----------	---

- (a) "600 ohm speaker"
- (b) "To 115/230 volts AC 48 to 62 CPS"
- (c) "Balanced 600 ohm audio line to auxiliary equipment"

Add: "The cables are now terminated with "AN" plugs which are connected to the receptacles shown in Figure 1 of T-1(A) NAVSHIPS 93053."

12,14, 15	Figure 7	Delete illustrations 8 to 19 inclusive.
--------------	----------	---

13	WARNING	Delete second sentence. Add at end of paragraph: "To prevent shock hazard to personnel, be sure terminal 16 on rear panel is grounded to ships hull thru J903-P903 pin B."
----	---------	--

<u>PAGE NO</u>	<u>PARA & LINE or FIG & LOCATION</u>	<u>ACTION</u>
21	15 (e) Step 2	Delete: "Loudspeaker connected to LOCAL AUDIO terminals 6 and 7, or"
	Step 3	Add after 13: "....via P902 and J902." Delete: "If 600 ohm line is not available, connect headset to terminals for test purposes."

Volume III

126	Figure 75	Delete "16 GND" and add: "Ground common lead of electronic multimeter at any convenient point on the receiver."
130	Figure 76	Add: "Connections to terminal boards TB102 and TB103 must be made from inside the receiver."
134	Figure 77	Same as Figure 76.
140	Figure 79	Same as Figure 76.
142	Figure 80	Same as Figure 76.
178	Figure 89 (Sheet 1)	Change Fig. 89, sheet 1, to show AC input power in accordance with Figure 1 center drawing of T-1(A) NAVSHIPS 93053.
179	Figure 89	Change Fig. 89, sheet 2, to show audio output in accordance with Fig. 1 of T-1(A) NAVSHIPS 93053.

SUPPLEMENTAL SCHEMATIC DIAGRAM

FIGURE 89 (2) --- NAVSHIPS 93053

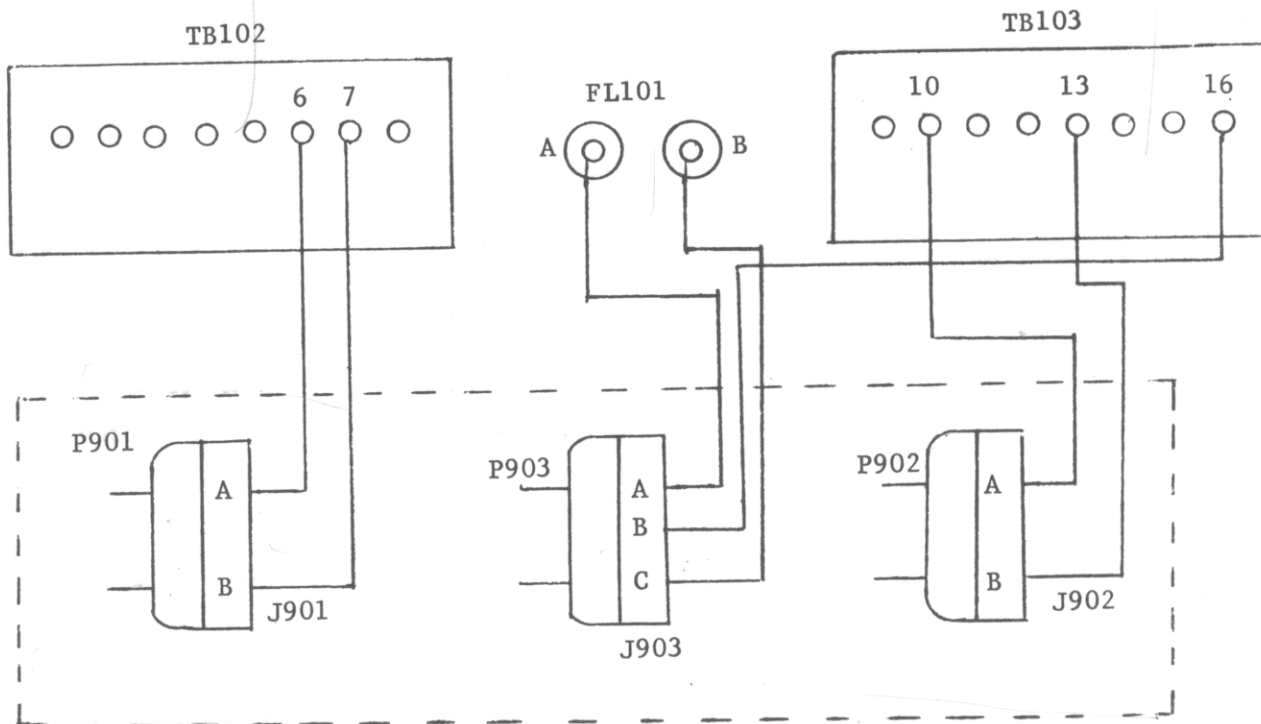

J901 is MS3102A10SL-4P
 J902 same as J901
 J903 is MS3102A16S-5P

P901 is MS3108B-10SL-4S or MS3106B-10SL-4S
 P902 same as P901
 P903 is MS3108B-16S-5S or MS3106-B-16S-5S

P901-P902 have Cable Clamp MS3057-4
 P903 has Cable Clamp MS3057-8

Figure 1

TEMPORARY CHANGE T-1 to ELECTRONICS FIELD CHANGE BULLETIN 6-R-390A/URR-
NAVSHIPS 0967-063-2110.

An error appears in the Field Change Bulletin for Field Change 6-R-390A/URR, NAVSHIPS 0967-063-2110. Activities installing this field change should make the following corrections to the bulletin and temporary correction prior to accomplishment:

Delete reference to "Pin 4" of XV801 and XV802. Insert "Pin 3" in lieu of "Pin 4."

On page 3 of bulletin, page 8(a) and (b):

On page 1 of Correction T-2, line "Page 45, Fig. 28."

On page 2 of Correction T-2, line "Page 178, Fig. 89."

This correction material appeared in EIB 702 dated 13 March 1967.

17 NOV 1969
SHIPYARD TECHNICAL LIBRARY
(CODE 246-P)
PEARL HARBOR NAVAL SHIPYARD
BOX 400
FPO SAN FRANCISCO 96610

T-1 to NAVSHIPS 93053

7 August 1963

TEMPORARY CORRECTION T-1 TO TECHNICAL MANUAL FOR
RADIO RECEIVER R-390A/URR
NAVSHIPS 93053

This temporary correction revises the manual to reflect the equipment changes made by Field Change 3-R-390A/URR. The purpose of this field change is to alter the electrical access at the rear of the receiver from terminal strips (TB102, TB103) to "AN" type connectors. If it becomes necessary to remove the receiver from its cabinet, it will be necessary only to unfasten three connectors instead of the individual wires at the terminal strips. The field change applies to all R-390A/URR receivers, all serial numbers.

Maintenance Support Activities shall make this correction in the technical manual immediately but shall keep the superseded data intact for support of equipments that have not been modified.

Holders of equipment accompanied by technical manuals shall not make this correction in the manuals until accomplishment of the field change.

Make the following pen-and-ink corrections. Insert this temporary correction in the technical manuals immediately after the front cover.

<u>PAGE</u> <u>NO</u>	<u>PARA & LINE or</u> <u>FIG & LOCATION</u>	<u>ACTION</u>
--------------------------	--	---------------

Volume I

11	Figure 7	Add: "This panel is now modified. See Figure 1 of this correction."
----	----------	---

Volume II

9	Figure 5	Delete those parts of the illustration associated with: <ul style="list-style-type: none"> (a) "600 ohm speaker" (b) "To 115/230 volts AC 48 to 62 CPS" (c) "Balanced 600 ohm audio line to auxiliary equipment"
---	----------	---

The cables are now terminated with "AN" plugs which are connected to the receptacles shown in Figure 1 of this temporary correction.

<u>PAGE NO</u>	<u>PARA & LINE or FIG & LOCATION</u>	<u>ACTION</u>
12, 14, 15	Figure 7	Delete illustrations 8 to 19 inclusive
13	WARNING	Change: "...connect GND terminal 16 on the rear panel to the same ground as the power source." to: "...be sure that the receiver is grounded to the same source as the AC power."
21	15 (e) Step 2	Delete: "Loudspeaker connected to LOCAL AUDIO terminals 6 and 7, or..."
	Step 3	Add after 13: "via P902 and J902." Delete: "If 600 ohm line is not available, connect headset to terminals for test purposes."
Volume III		
126	Figure 75	Delete "16 GND" and add: "Ground common lead at any convenient point on the receiver."
130	Figure 76	Add: "Connections to terminal strips TB102 and TB103 must be made from inside the receiver."
134	Figure 77	Same as Figure 76.
140	Figure 79	Same as Figure 76.
142	Figure 80	Same as Figure 76.
179	Figure 89 (Sheet 2)	Add: "For wiring of connector channel on back panel of receiver, see Figure 1 of this correction. It is recommended that Figure 1 be inserted between Figure 89(1) and Figure 89(2)."

SUPPLEMENTAL SCHEMATIC DIAGRAM
 FIGURE 89 (2) — NAVSHIPS 93053

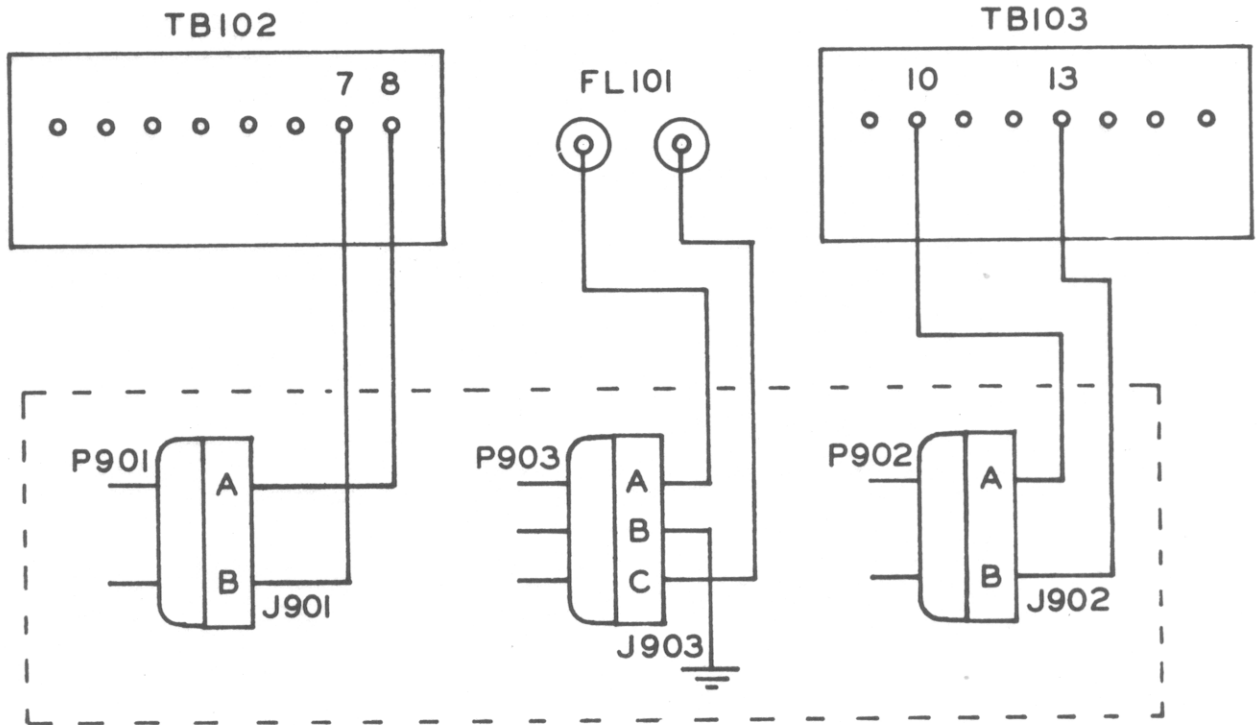

J901 IS MS3102A10SL-4P
 J902 SAME AS J901
 J903 IS MS3102A16S-5P

P901 IS MS3108B-10SL-4S
 P902 SAME AS P901
 P903 IS MS3108B-16S-5S

P901-P902 HAVE CABLE CLAMP MS3057-4
 P903 HAS CABLE CLAMP MS3057-8

FIGURE I.

TECHNICAL MANUAL }
 No. 11-5820-358-10 }

NAVSEEACTION 13/17ND
 LIBRARY

HEADQUARTERS,
 DEPARTMENT OF THE ARMY
 WASHINGTON 25, D. C., 16 January 1961

RADIO RECEIVER R-390A/URR

		<i>Paragraph</i>	<i>Page</i>
CHAPTER	1.	INTRODUCTION	
Section	I.	General	
		Scope	1 3
		Forms and records	2 3
	II.	Description and data	
		Purpose and use	3 3
		System application	4 3
		Technical characteristics	5 5
		Components of Radio Receiver R-390A/URR	6 5
		Description	7 5
		Additional equipment required	8 6
CHAPTER	2.	OPERATING INSTRUCTIONS	
Section	I.	Controls and instruments	
		General	9 8
		Receiver controls and indicators	10 8
	II.	Operation	
		Preparing receiver for reception	11 9
		Calibration	12 9
		Tuning receiver for voice reception	13 9
		Mcw or cw reception	14 9
		Reception of frequency-shift signals	15 9
		Single-sideband reception	16 9
		Stopping procedure	17 24
		Antijamming instructions	18 24
CHAPTER	3.	MAINTENANCE INSTRUCTIONS	
		Scope of operator's maintenance	19 26
		Preventive maintenance	20 26
		Checking fuses	21 26
		Visual inspection	22 26
		Operational checklist	23 26
CHAPTER	4.	SHIPMENT AND LIMITED STORAGE AND DEMOLITION TO PREVENT ENEMY USE	
Section	I.	Shipment and limited storage	
		Disassembly	24 30
		Repacking for shipment or limited storage	25 30
	II.	Demolition of materiel to prevent enemy use	
		Authority for demolition	26 30
		Methods of destruction	27 30
APPENDIX	I.	REFERENCES	31
	II.	BASIC ISSUE ITEMS LIST, RADIO RECEIVER R-390A/URR	32

*This manual supersedes so much of TM 11-856A, 20 January 1956, including C1, 19 March 1956; C2, 17 May 1956; C3, 23 November 1956; C4, 7 June 1957; C5, 23 July 1958, and C6, 13 November 1958, as pertains to the operation of the equipment.

NAVSEEACTION 13/17ND
 LIBRARY

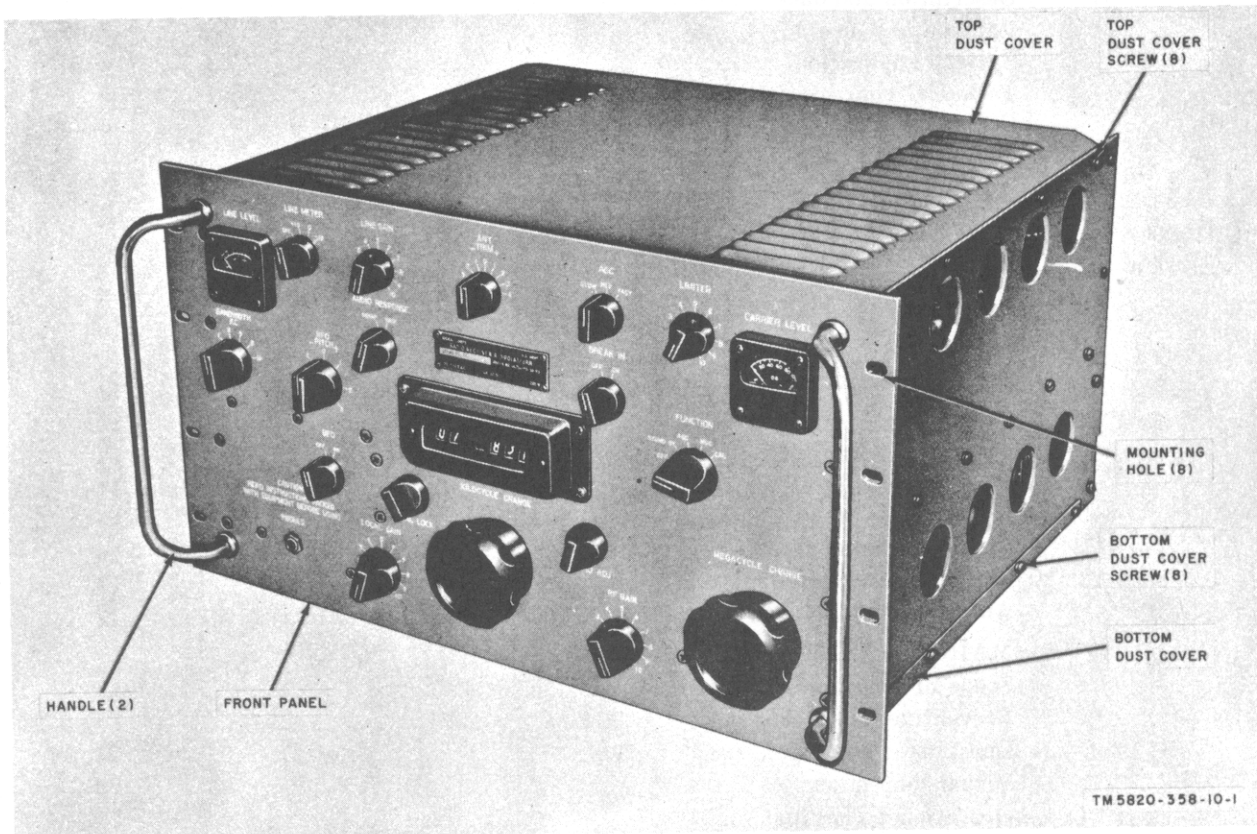

Figure 1. Radio Receiver R-390A/URR.

CHAPTER 1

INTRODUCTION

Section I. GENERAL

1. Scope

This manual describes Radio Receiver R-390A/URR (fig. 1) and covers its operation, and operator's maintenance. It includes cleaning and inspection of the equipment and replacement of parts available to first echelon maintenance. Throughout this manual, Radio Receiver R-390A/URR is referred to as the receiver.

2. Forms and Records

a. *Unsatisfactory Equipment Reports.*

- (1) Fill out and forward DA Form 468 (Unsatisfactory Equipment Report) to the Commanding Officer, U. S. Army Signal Materiel Support Agency, ATTN: SIGMS-ML, Fort Monmouth, N. J., as prescribed in AR 700-38.
- (2) Fill out and forward AF TO Form 29 (Unsatisfactory Report) to the Commander, Air Materiel Command, Wright-Patterson Air Force Base, Ohio, as prescribed in AF TO 00-35D-54.

b. *Report of Damaged or Improper Shipment.* Fill out and forward DD Form 6 (Report of Damaged or Improper Shipment) as prescribed in AR 700-58 (Army), Navy Shipping Guide, Article 1850-4 (Navy), and AFR 71-4 (Air Force).

c. *Preventive Maintenance Form.* Prepare DA Form 11-238 (fig. 15), (Maintenance Check List for Signal Equipment (Sound Equipment, Radio, Direction Finding, Radar, Carrier, Radiosonde, and Television)) in accordance with instructions on the form.

d. *Parts List Form.* Forward DA FORM 2028, (Recommended Changes to DA Technical Parts Lists or Supply Manuals 7, 8, or 9) directly to the Commanding Officer, U. S. Army Signal Materiel Support Agency, ATTN: SIGMS-ML, Fort Monmouth, N. J., with comments on parts listings in Appendix II.

e. *Comments on Manual.* Forward all other comments on this publication directly to the Commanding Officer, U. S. Army Signal Materiel Support Agency, ATTN: SIGMS-PA2d, Fort Monmouth, N. J.

Section II. DESCRIPTION AND DATA

3. Purpose and Use

a. The receiver (fig. 1) is a general-purpose receiver for use in both fixed and mobile applications. The receiver provides reception of continuous-wave (cw), modulated-continuous-wave (mcw), amplitude-modulated (am.), frequency-shift keyed (fsk), and single-sideband (ssb) signals.

b. The receiver furnishes audiofrequency (af) output power to a local loudspeaker and headset or a balanced line. An intermediate frequency (if.) output is also provided so that received radio teletypewriter signals may be fed to other equipment for conversion into signals usable by teletypewriter printers.

c. The calibration of the receiver is ac-

curate to within 300 cps; this permits use of the receiver as a frequency meter.

4. System Application

a. *Space-Diversity Receiving System.*

- (1) Two or three receivers can be connected as a space-diversity receiving system for reception of voice signals (fig. 2). This system provides substantially uniform audio output to a loudspeaker or headset, minimizing the effect of fading signals.
- (2) Rhombic or doublet antennas spaced at least 600 feet apart are connected to the two receivers.

b. *Space-Diversity Radio Teletypewriter*

System. Figure 3 shows two receivers connected in a space-diversity radio teletypewriter system. The doublet or rhombic antennas feed the incoming frequency-shift signals to the receivers. The outputs of the receivers are applied to a converter which provides diversity combining and produces direct current (dc) signals for the operation of teletypewriter equipment.

c. Single-Sideband Radio Teletypewriter System. A receiver and a single sideband converter may be connected as shown in figure 4.

This system permits the reception of single-sideband (ssb) signals, occupying 12 kc of rf spectrum space divided into two 6-kc sidebands, one 6-kc sideband on each side of a reduced carrier. A double-sideband signal, either am. or phase-modulated (pm), occupying up to a total of 12 kc of spectrum space also can be received. This system is used primarily for the reception of multichannel radio-teletypewriter transmissions. For additional information, refer to TM 11-649.

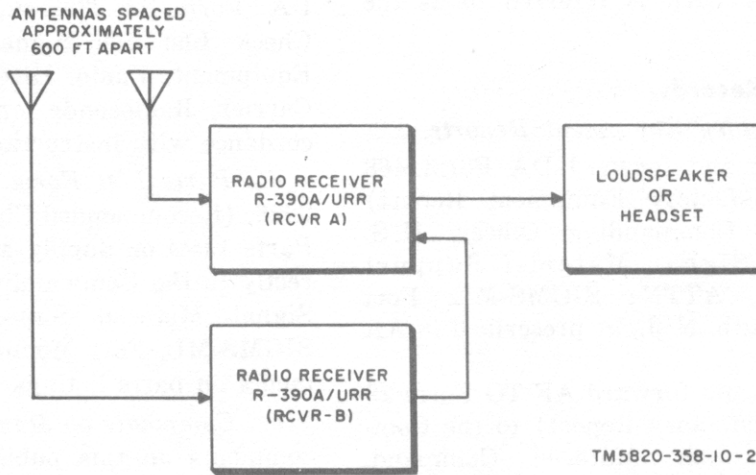

Figure 2. Space-diversity receiving system, block diagram.

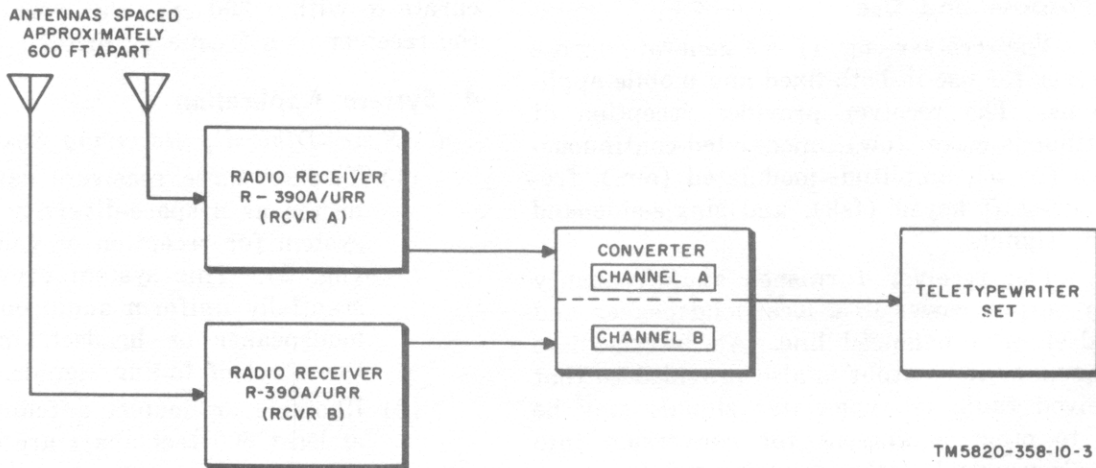

Figure 3. Space-diversity radio teletypewriter receiving system, block diagram.

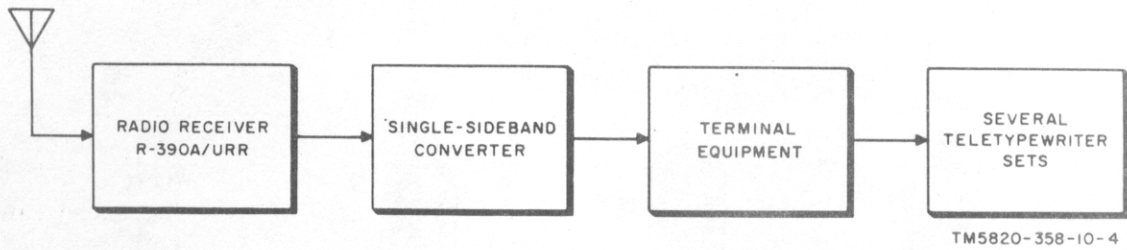

Figure 4. Single-sideband radio teletypewriter receiving system, block diagram.

5. Technical Characteristics

Frequency range 0.5 to 32 mc.
 Type of signals Cw, mcw, voice, ssb, fsk.
 received
 Type of tuning Continuous; frequency
 read directly on coun-
 tertype indicator.
 Method of Built-in crystal-controlled.
 calibration
 Calibration points .. Every 100 kc.
 Power source 115 or 230 volts ac $\pm 10\%$,
 48 to 62 cps.
 Power input 250 watts total; 140 watts
 with OVENS switch
 turned to OFF.

Antenna

requirements:

Unbalanced Straight wire of random
 length or vehicular-
 mounted whip.

Balanced 125-ohm terminating im-
 pedance; matches 50-
 to 200-ohm balanced or
 unbalanced transmis-
 sion line by use of adap-
 ters.

6. Components of Radio Receiver R-390A/URR

a. *Components.* The components of Radio Receiver R-390A/URR are listed in the following table:

Quantity	Item	Fig. No.	Height (in.)	Depth (in.)	Width (in.)	Unit weight (lb)
1	Radio Receiver R-390A/URR	1	10 15/32	16 19/32	19	75
2	TM 11-5820-358-10					
1 set	Running spares (b below)	5				1

b. *Running Spares.* (fig. 5). The following is a list of running spares except as noted.

Quantity	Item
1	Electron tube, OA2
1	Electron tube, 6AK6
1	Electron tube, 6C4
1	Electron tube, 6DC6
1	Electron tube, 26Z5W
1	Electron tube, 5654/6AK5W
2	Electron tube, 5749/6BA6W
2	Electron tube, 5814A
5	Fuses, 3-ampere, 250-volt
1	Lamp, incandescent, 6-volt, 0.2-ampere, Federal Spec. No. W-L-11
1	Resistor, current-regulating
5	^a Fuses, 1/4-ampere, 250-volt
5	^a Fuses, 1/8-ampere, 250-volt

^a Only on receivers bearing Order No. 15-PHILA-56, serial numbers 2683 and above, and Order No. 14385-PHILA-58.

7. Description

a. The receiver (fig. 1 and 6) is designed for mounting in a standard 19-inch rack or a table-top cabinet.

b. All operating controls, indicators, and a PHONES jack are located on the front panel. Two handles are provided to aid in removal of the receiver from the rack or cabinet. The chassis is enclosed by dust covers which may be removed when the receiver is installed in a cabinet.

c. Antenna connectors, operating and spare fuses, a power cord, an if. connector, an OVENS switch, terminal boards, and special tools are mounted on the rear panel (fig. 7).

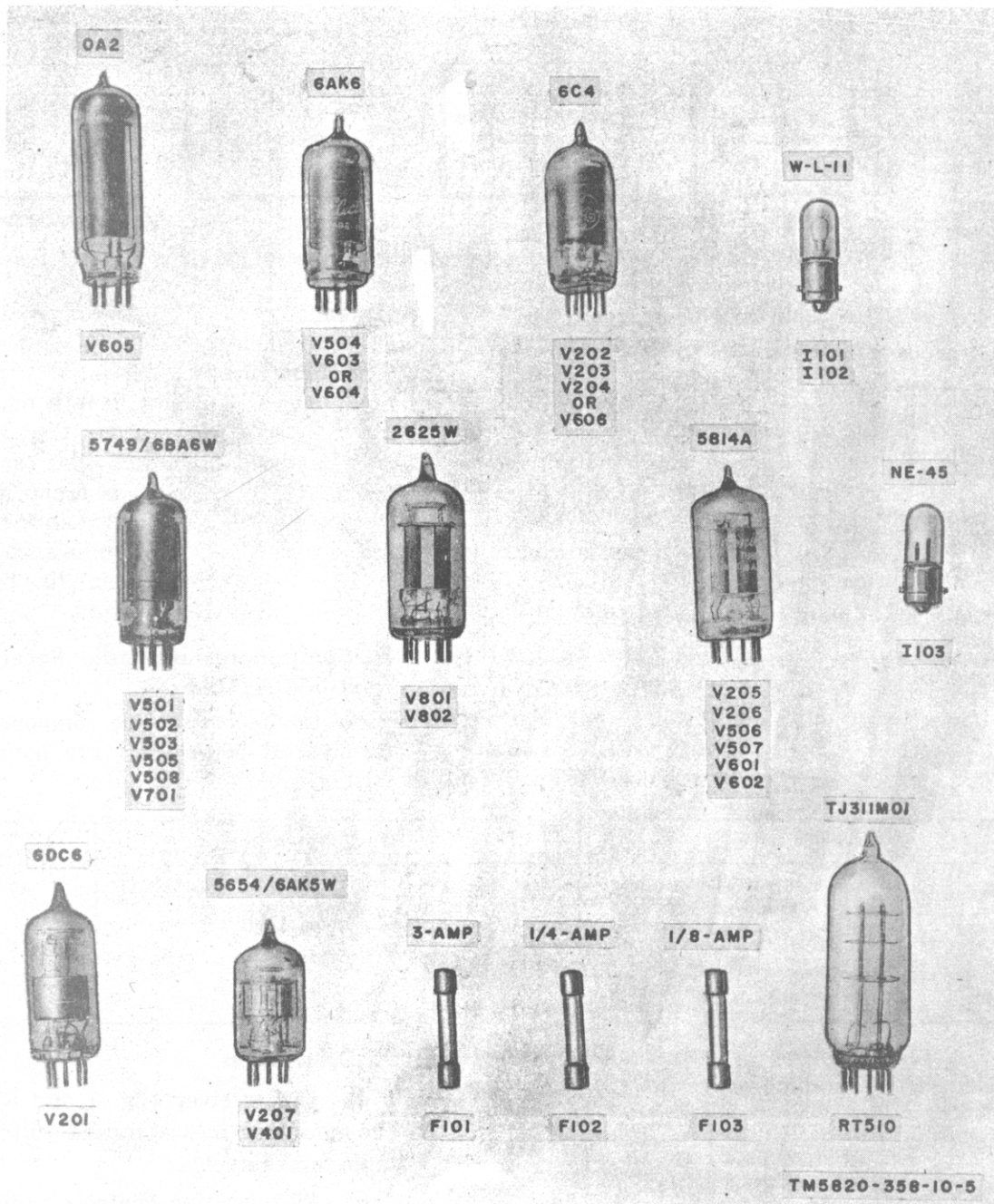

Figure 5. Running spares.

Cutouts are provided to permit access to internal controls.

8. Additional Equipment Required

The following material is *not* supplied as a part of Radio Receiver R-390A/URR but is required for its operation. The connectors required will depend on the particular installation.

Antenna:

Balanced Doublet or rhombic.
 Unbalanced Random-length straight-wire or whip.

Low-impedance transmission line:

Balanced 50 to 200 ohms.
 Unbalanced 70-ohm coaxial cable.

Connector	Connector Plug UG-573/U or Connector Plug PL-259.	917/URR (Mobile) CY-1216/U or CY-979/URR
Headset	Headset Navy type CW-49507 or equivalent 600-ohm headset.	Adapter Connector UG-970/U
Cord	Headset Cord CX-1334/U, or equivalent.	Adapts Connector Plug PL-259 on unbalanced antenna lead-in to balanced antenna input.
Loudspeaker	LS-166/U, or equivalent.	Adapter Connector UG-971/U
Mounting and housing facilities	Standard 19-inch rack or cabinet such as: (Fixed) CY-1119/U or CY-	Adapts Connector Plug UG-573/U on unbalanced antenna lead-in to balanced antenna input.

CHAPTER 2

OPERATING INSTRUCTIONS

Section I. CONTROLS AND INSTRUMENTS

9. General

Haphazard operation or improper setting of the controls can result in poor reception; therefore, it is important to know the function of every control. The actual operation of the equipment is given in paragraphs 11 through 18.

Cautions:

1. Do not turn the MEGACYCLE CHANGE

control beyond 00 or 31 megacycles.

2. Do not turn the KILOCYCLE CHANGE control beyond 000 counterclockwise or 999 clockwise. If a + or - appears in the third frequency indicator column from the left, the control has been turned too far.

3. Do not turn the FUNCTION switch counterclockwise beyond OFF or clockwise beyond CAL.

10. Receiver Controls and Indicators (fig. 6)

Control or indicator	Function										
LINE LEVEL meter	Indicates level of balanced-line audio output.										
LINE METER switch	Meter switch has four positions: <table style="width: 100%; border: none;"> <thead> <tr> <th style="text-align: left; border: none;"><i>Sw Pos</i></th> <th style="text-align: left; border: none;"><i>Effect</i></th> </tr> </thead> <tbody> <tr> <td style="border: none;">OFF</td> <td style="border: none;">Disconnects meter from balanced-line audio output.</td> </tr> <tr> <td style="border: none;">+10</td> <td style="border: none;">Adds 10 vu to LINE LEVEL meter vu indication.</td> </tr> <tr> <td style="border: none;">0</td> <td style="border: none;">Reads LINE LEVEL meter directly.</td> </tr> <tr> <td style="border: none;">-10</td> <td style="border: none;">Subtracts 10 vu from LINE LEVEL meter indication.</td> </tr> </tbody> </table>	<i>Sw Pos</i>	<i>Effect</i>	OFF	Disconnects meter from balanced-line audio output.	+10	Adds 10 vu to LINE LEVEL meter vu indication.	0	Reads LINE LEVEL meter directly.	-10	Subtracts 10 vu from LINE LEVEL meter indication.
<i>Sw Pos</i>	<i>Effect</i>										
OFF	Disconnects meter from balanced-line audio output.										
+10	Adds 10 vu to LINE LEVEL meter vu indication.										
0	Reads LINE LEVEL meter directly.										
-10	Subtracts 10 vu from LINE LEVEL meter indication.										
LINE GAIN control	Controls level of signal applied to balanced-line audio output terminals.										
AGC switch	Determines rapidity of change in gain of receiver for a change of signal strength.										
LIMITER switch and control	Increasing clockwise rotation of control increases reduction of static interference.										
CARRIER LEVEL meter	Indication of 0 db with RF GAIN control at 10 corresponds to an input signal of approximately 2 microvolts.										
BANDWIDTH switch	Causes the receiver to reject frequencies that differ from the carrier frequency by more than the amount adjusted for.										
BFO switch	Makes cw signals audible.										
BFO PITCH control	Varies tone when receiving cw signals.										
AUDIO RESPONSE switch	<table style="width: 100%; border: none;"> <thead> <tr> <th style="text-align: left; border: none;"><i>Sw Pos</i></th> <th style="text-align: left; border: none;"><i>Effect</i></th> </tr> </thead> <tbody> <tr> <td style="border: none;">Sharp</td> <td style="border: none;">800 cps tone is loudest; used for cw.</td> </tr> <tr> <td style="border: none;">Wide</td> <td style="border: none;">Most voice frequencies are heard.</td> </tr> </tbody> </table>	<i>Sw Pos</i>	<i>Effect</i>	Sharp	800 cps tone is loudest; used for cw.	Wide	Most voice frequencies are heard.				
<i>Sw Pos</i>	<i>Effect</i>										
Sharp	800 cps tone is loudest; used for cw.										
Wide	Most voice frequencies are heard.										
BREAK IN switch	Permits break-in operation with proper connections have been made at rear panel.										
FUNCTION switch	Function switch has five positions. <table style="width: 100%; border: none;"> <thead> <tr> <th style="text-align: left; border: none;"><i>Sw Pos</i></th> <th style="text-align: left; border: none;"><i>Effect</i></th> </tr> </thead> <tbody> <tr> <td style="border: none;">OFF</td> <td style="border: none;">Receiver is turned completely off.</td> </tr> <tr> <td style="border: none;">STAND BY</td> <td style="border: none;">Receiver inoperative, but ready for instant use.</td> </tr> </tbody> </table>	<i>Sw Pos</i>	<i>Effect</i>	OFF	Receiver is turned completely off.	STAND BY	Receiver inoperative, but ready for instant use.				
<i>Sw Pos</i>	<i>Effect</i>										
OFF	Receiver is turned completely off.										
STAND BY	Receiver inoperative, but ready for instant use.										

Control or indicator	Function
AGC	Receiver operative, with gain controlled automatically.
MGC	Receiver operative, with gain controlled by RF GAIN control or by an external control.
<i>Sw Pos</i> Cal	<i>Effect</i> Permits calibration of the tuning system at 100-kc checkpoints.
ANT TRIM control	Permits peaking of received signal to maximum value.
DIAL LOCK	When turned clockwise, locks KILOCYCLE CHANGE control to prevent accidental change of setting.
ZERO ADJ	When turned clockwise, disengages frequency indicator from KILOCYCLE CHANGE control for calibration purposes.
LOCAL GAIN control	Controls level of af signal applied to local headset or loudspeaker.
RF GAIN control	Manual control of amplification of received signal.
MEGACYCLE CHANGE control	Selects any one of 32 tuning bands in steps of 1 megacycle; changes reading of first two digits of frequency indicator.
KILOCYCLE CHANGE control	Tunes receiver to any frequency within a 1-megacycle band; changes reading of last three digits of frequency indicator.
PHONES jack	Provides means of connecting headset to receiver.

Section II. OPERATION

11. Preparing Receiver for Reception

A sample frequency of 07.275 megacycles will be used in paragraphs 11 through 15; it is understood that the operator will substitute the desired frequency. For preparatory procedure, refer to figure 8.

12. Calibration

The receiver is now ready for calibration. To maintain maximum tuning accuracy, calibrate the frequency indicator at the 100-kc point nearest the desired frequency. Recalibrate whenever the MEGACYCLE CHANGE control is turned. Start with the controls set as in paragraph 11. For calibration procedure, refer to figure 9.

13. Tuning Receiver for Voice Reception

Start with controls set as in paragraph 11. For voice reception tuning procedure, refer to figure 10.

14. Mcw or Cw Reception

Set up the controls the same as for voice reception (para 13). For mcw or cw reception, refer to figure 11.

15. Reception of Frequency-Shift Signals

The following procedure can be used for tuning the receiver to frequency-shift signals, unless another procedure is given in the technical manual covering the particular receiving system. The receiver requires exact tuning for this type of operation. The entire procedure applies only to systems that use the audio output of the receiver, such as Radioteletype Terminal Equipment AN/FGC-1. Omit the procedure given in step 4, figure 12, with equipments that use the if. output of the receiver, such as Frequency Shift Converter CV-116/URR. Set up the receiver the same as for mcw or cw reception (para 14). For reception of frequency-shift signals, refer to figure 12.

16. Single-sideband Reception

Tuning the receiver for ssb reception must be done accurately if this type of signal is to be received. Calibrate the receiver as shown in paragraph 12. Start with the receiver set up as in paragraph 14. For ssb tuning procedure refer to figure 13.

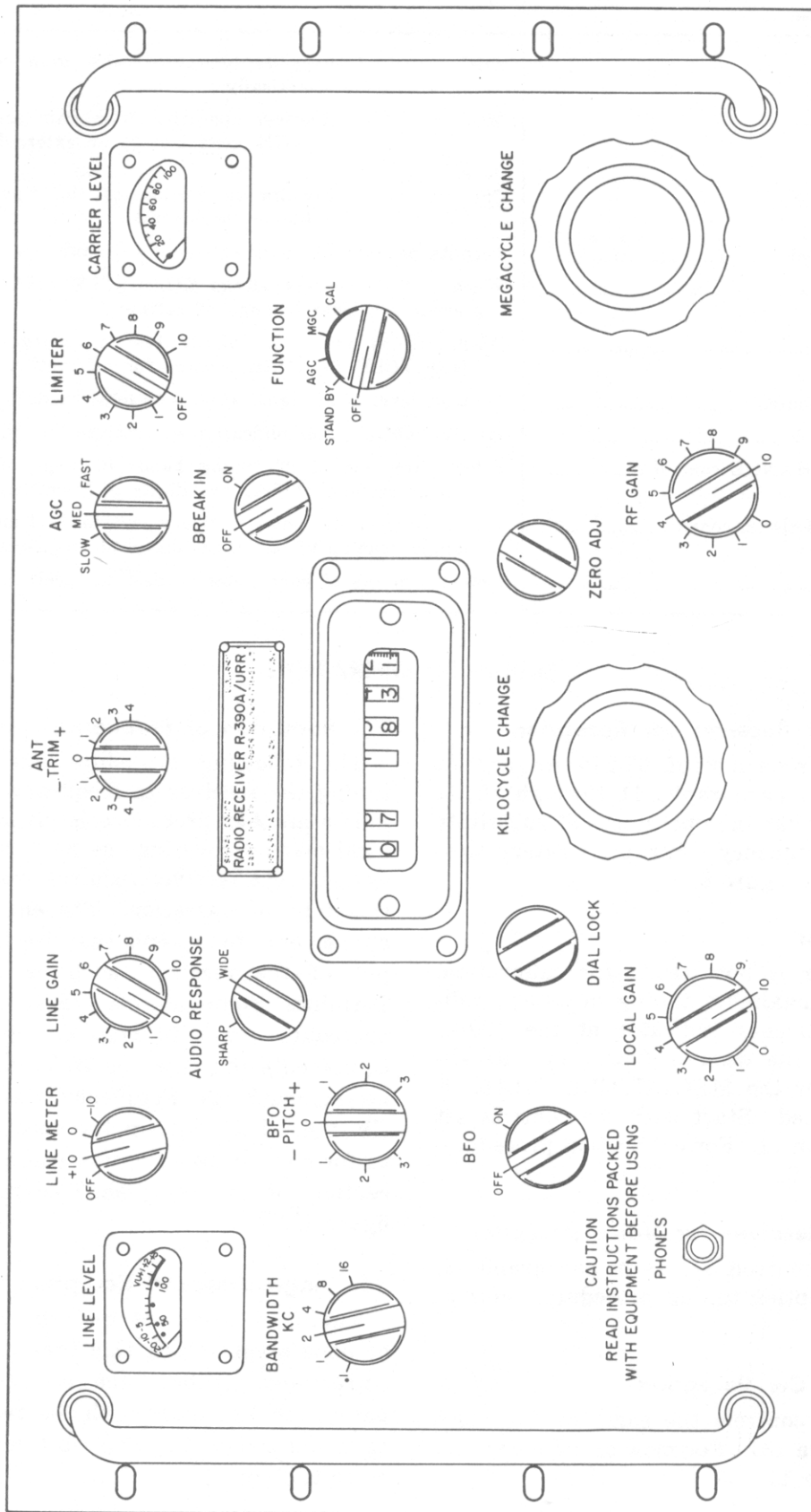

TM5820-358-10-9

Figure 6. Front panel.

14

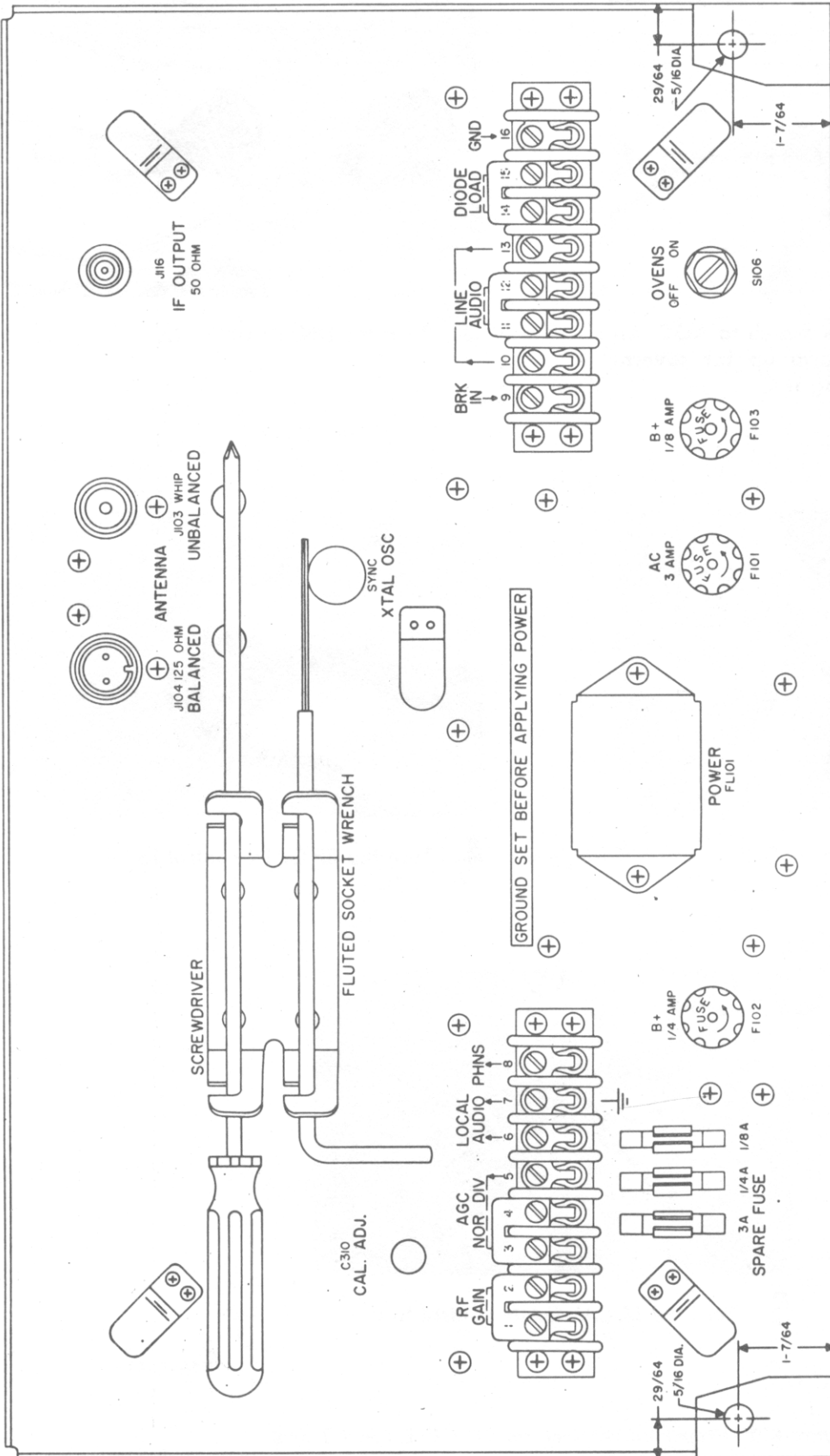

NOTE:
 FUSES F102 AND F103 APPEAR ONLY
 IN RECEIVERS BEARING ORDER NO.
 14-PHILA-56, SERIAL NUMBERS 2683
 AND ABOVE, AND ORDER NO. 14385-
 PHILA-56.

TW5820-358-10-10

Figure 7. Rear panel.

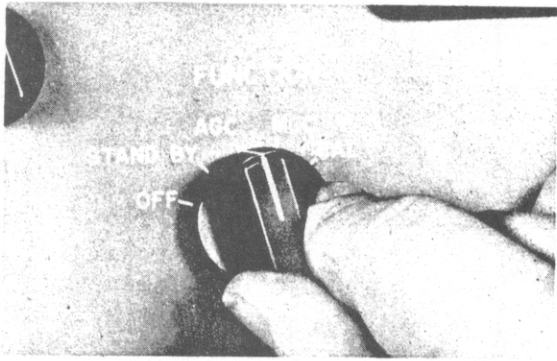

1 Turn the FUNCTION switch to AGC. Allow the receiver to warm up for several minutes before operating it.

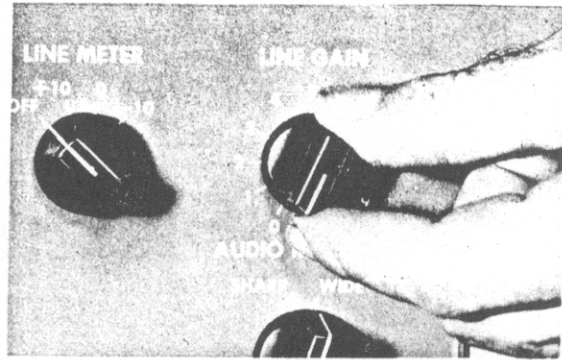

3 Turn the LINE GAIN to 0.

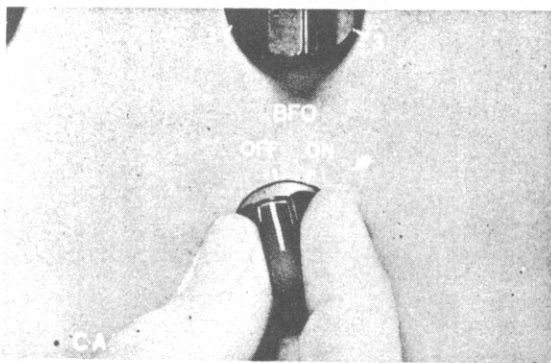

2 Turn the BFO switch to OFF.

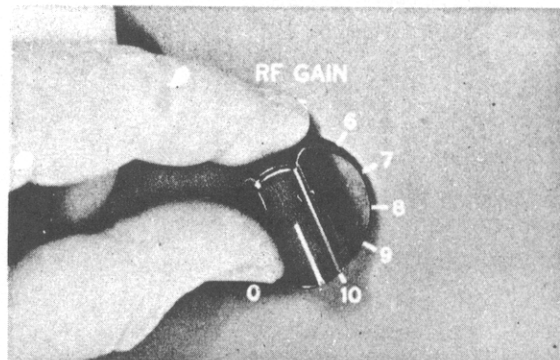

4 Turn the RF GAIN control to 10.



5 Turn the LOCAL GAIN control to 6.

TM5820-358-10-14 ①

Figure 8①. Preparing receiver for reception (part 1 of 2).

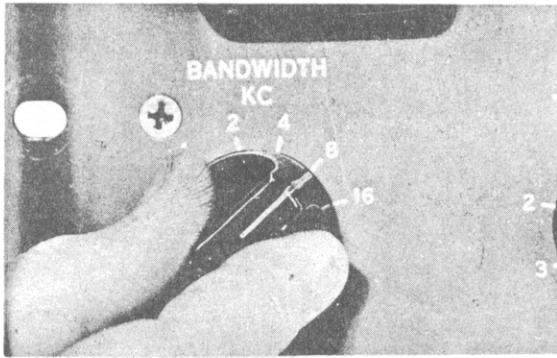

6 Turn the BANDWIDTH switch to 8.

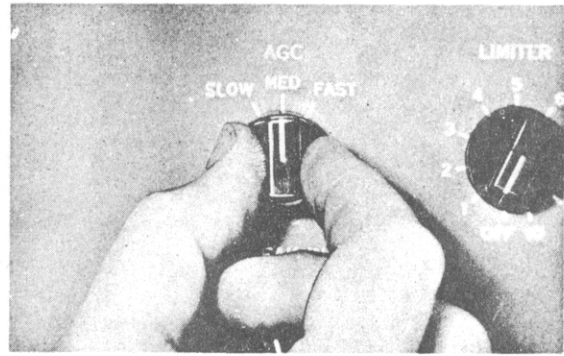

8 Turn the AGC switch to MED.

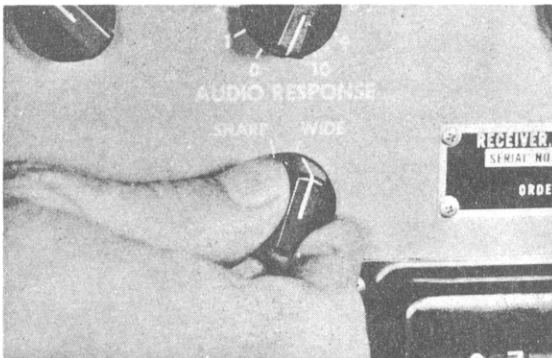

7 Turn the AUDIO RESPONSE switch to WIDE.

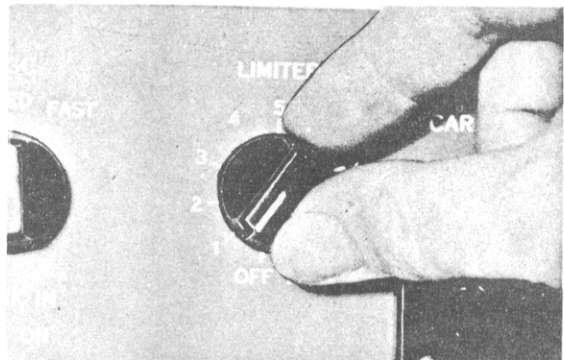

9 Turn the LIMITER control to OFF.

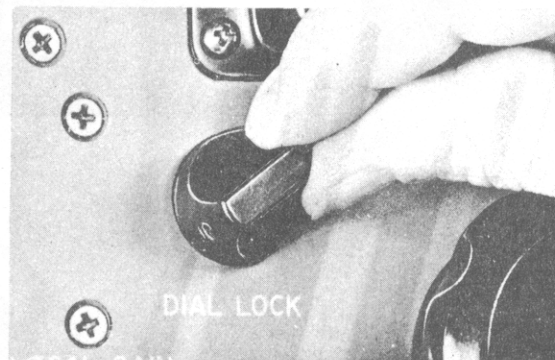

10 Turn the DIAL LOCK to the left until it stops.

TM5820-358-10-14②

Figure 8②. Preparing receiver for reception (part 2 of 2).

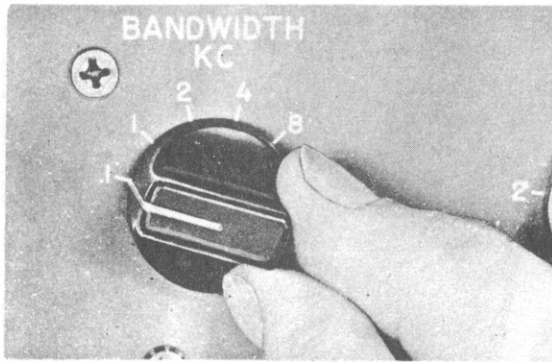

1 Turn the BANDWIDTH switch to .1.

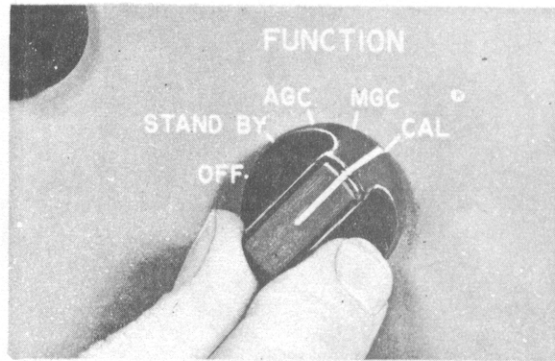

4 Turn the FUNCTION switch to CAL.

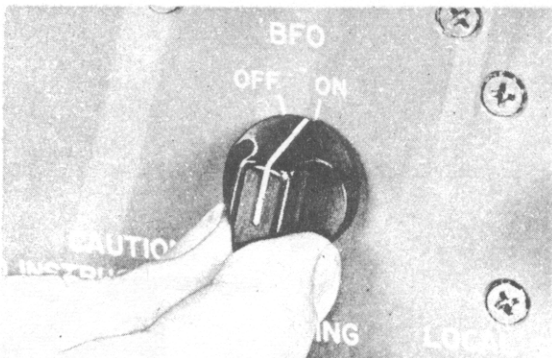

2 Turn the BFO switch to ON.

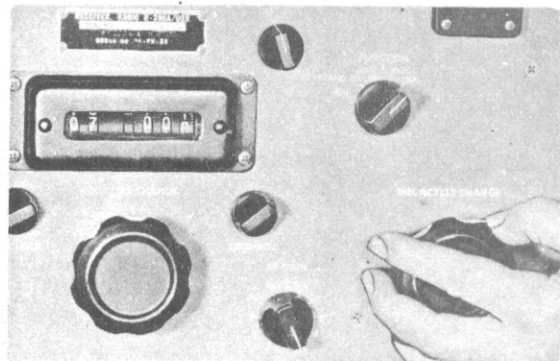

5 Turn the MEGACYCLE CHANGE control to the desired band.

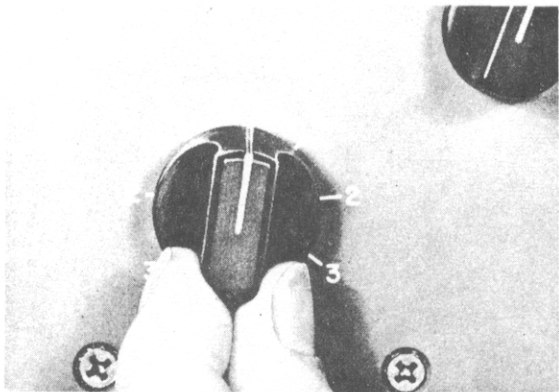

3 Turn the BFO PITCH control to 0.

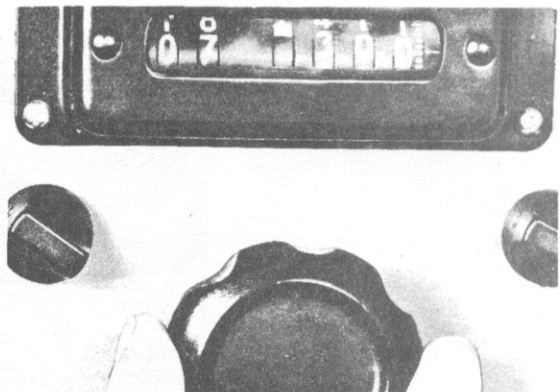

6 Turn the KILOCYCLE CHANGE control to the 100-kc point nearest the desired frequency.

TM5820-358-10-15 ①

Figure 9①. Calibration (part 1 of 2).

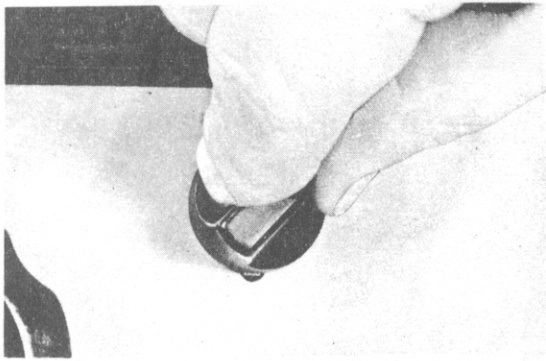

7 Turn the ZERO ADJ knob to the right until it stops.

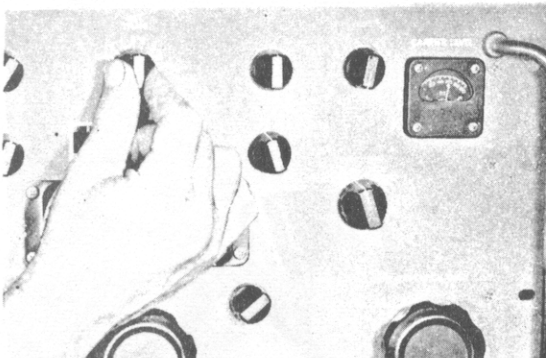

8 Adjust the ANT TRIM knob to obtain a maximum indication of the CARRIER LEVEL meter.

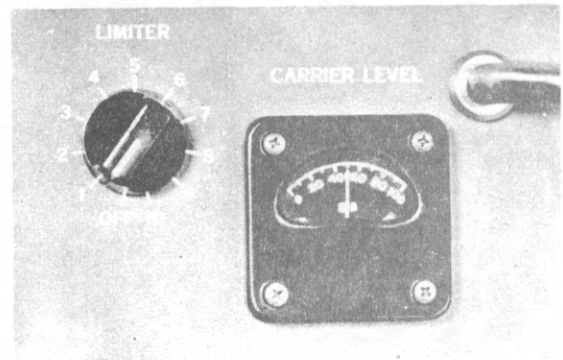

9 Adjust the KILOCYCLE CHANGE control for a maximum indication of the CARRIER LEVEL meter (step 6).

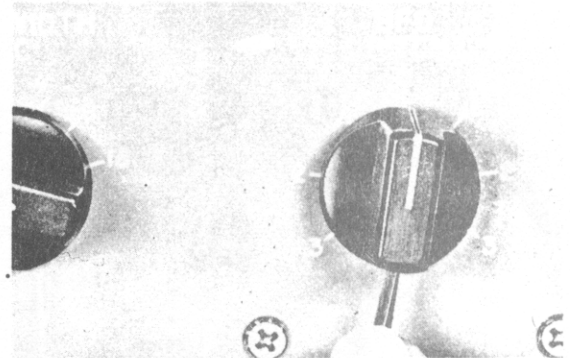

10 If the BFO PITCH control does not produce a zero beat at 0, tune it for zero beat, loosen the knob screw, and adjust the knob to zero without turning the shaft. Tighten the knob screw.

11 Turn the ZERO ADJ knob to the left until it stops. The dial is now calibrated accurately (step 7).

TM5820-358-10-15 (2)

Figure 9(2). Calibration (part 2 of 2).

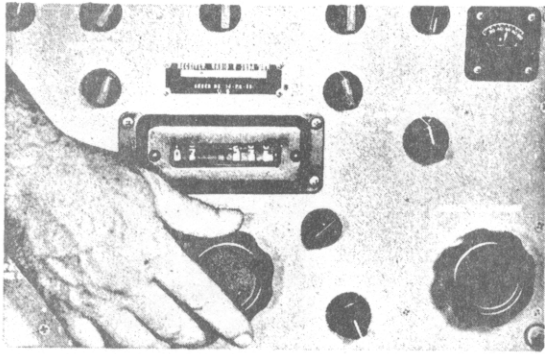

1 Turn the KILOCYCLE CHANGE control slightly toward the left or right of the desired station for a maximum CARRIER LEVEL meter indication (the MEGACYCLE CHANGE control has been set during calibration).

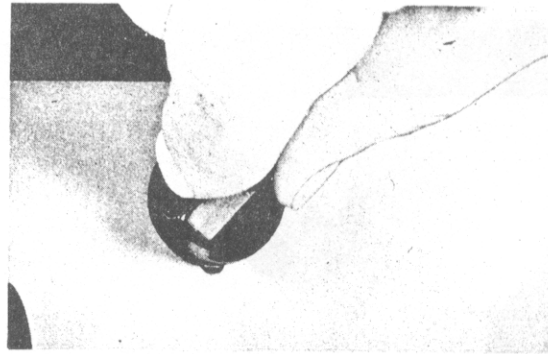

3 Turn the DIAL LOCK knob to the right until it stops.

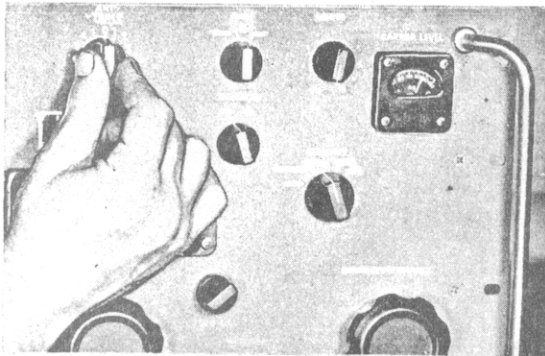

2 Adjust the ANT TRIM control for a maximum CARRIER LEVEL meter indication.



4 Adjust the LOCAL GAIN control for a comfortable volume level.

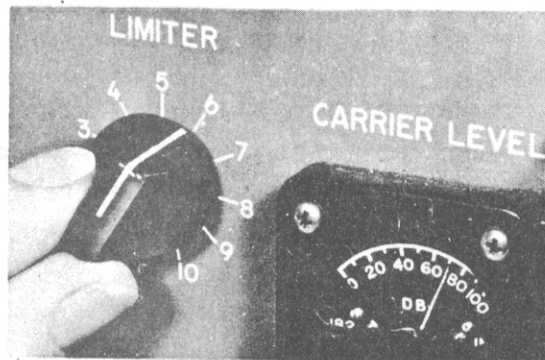

5 If there is excessive noise, turn the LIMITER control to the right as needed.

TM5820-358-10-16①

Figure 10①. Tuning receiver for voice reception (part 1 of 2).

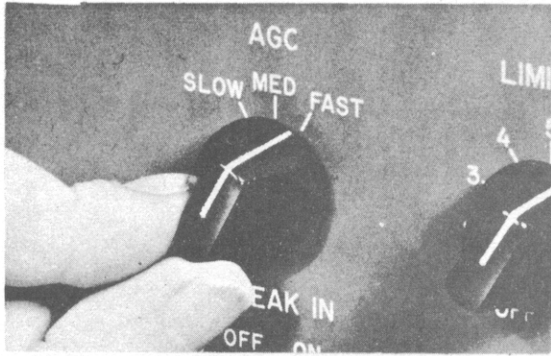

6 If the signal fades rapidly, turn the AGC control to FAST.

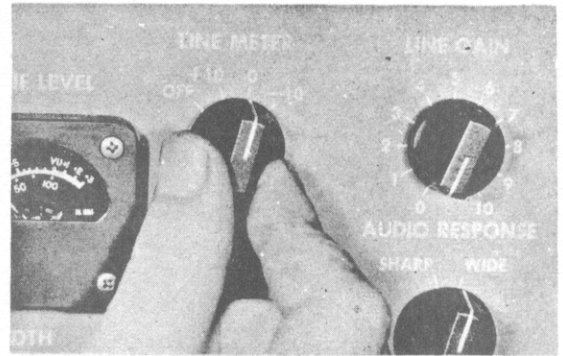

8 The LINE METER switch (when used) is usually set at 0.

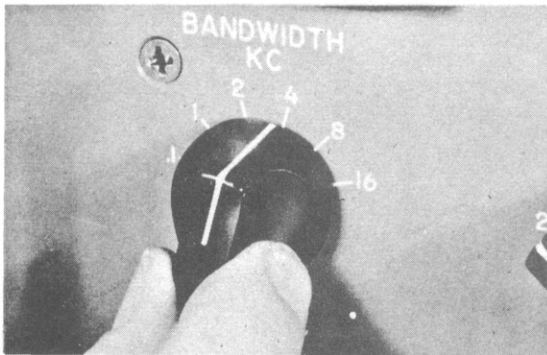

7 If another station is interfering, turn the BANDWIDTH switch to 4, or if necessary to 2.

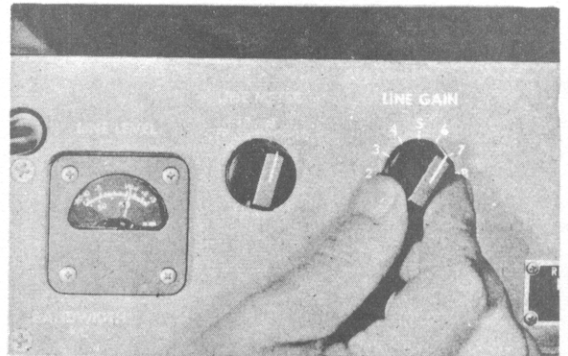

9 When the LINE METER switch is set at 0, the LINE GAIN control is usually adjusted for a LINE LEVEL meter indication at the VU mark.

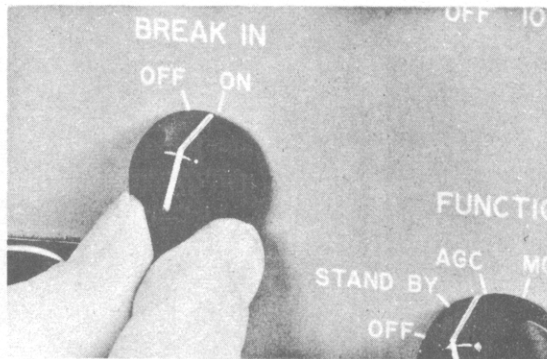

10 If the receiver is to be disabled during periods of transmission, turn the BREAK IN switch to ON.

TM5820-358-10-16 (2)

Figure 10(2). Tuning receiver for voice reception (part 2 of 2).

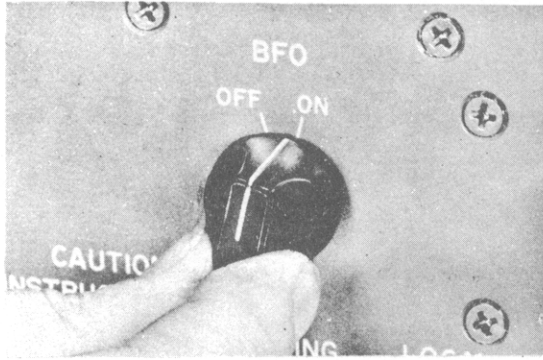

1 Turn the BFO switch to ON.

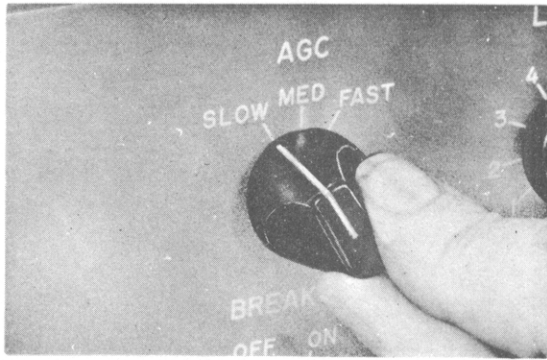

4 Turn the AGC switch to SLOW. If keying is at such a slow speed that noise is heard between characters, perform steps 5 and 6.

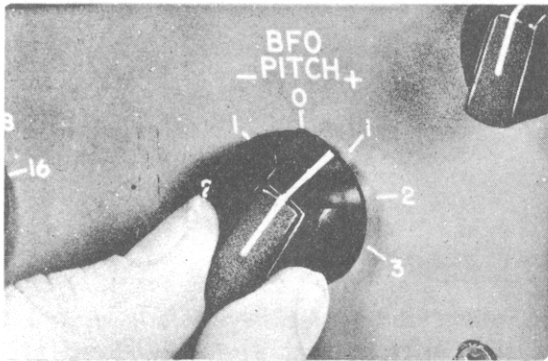

2 Adjust the BFO PITCH control for a comfortable tone.

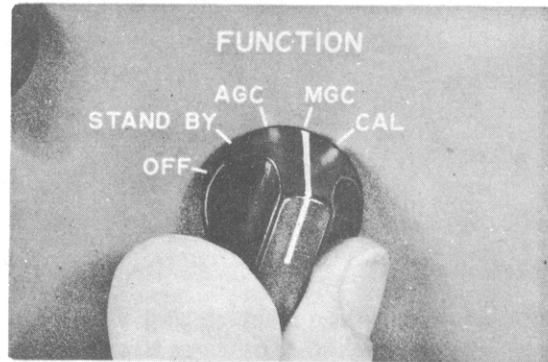

5 Turn the FUNCTION switch to MGC.

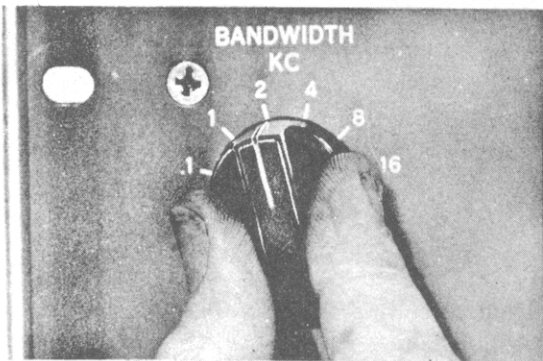

3 Turn the BANDWIDTH switch to 2, or if necessary to a lower position, to reduce adjacent channel interference.

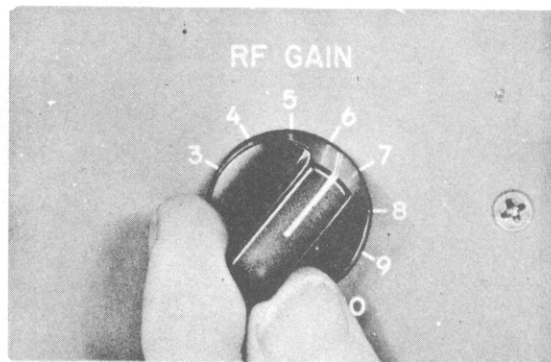

6 Reduce the RF GAIN control setting to prevent blocking. For greater selectivity during cw reception, perform steps 7, 8, 9, 10, and 11.

TM5820-358-10-17①

Figure 11①. Mew or cw reception (part 1 of 2).

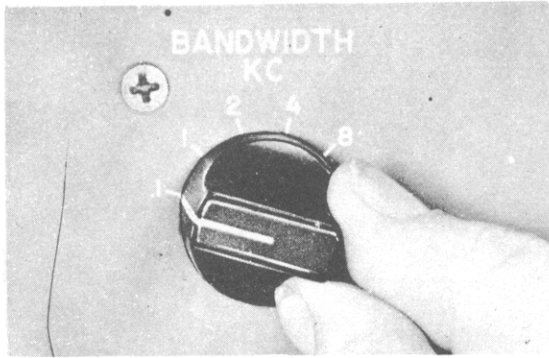

7 Turn the BANDWIDTH switch to .1.

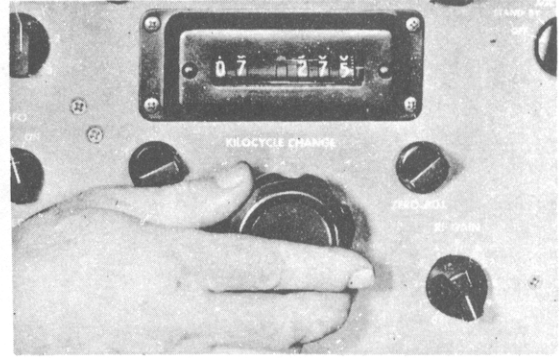

9 Tune the KILOCYCLE CHANGE control for zero beat.

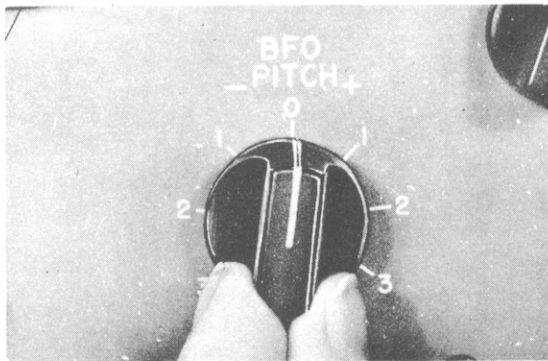

8 Turn the BFO PITCH control to 0.

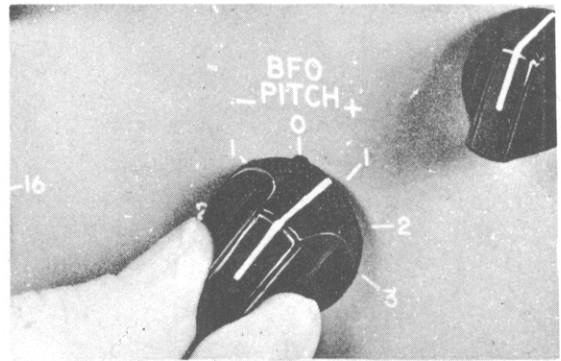

10 Adjust the BFO PITCH control for a comfortable tone.

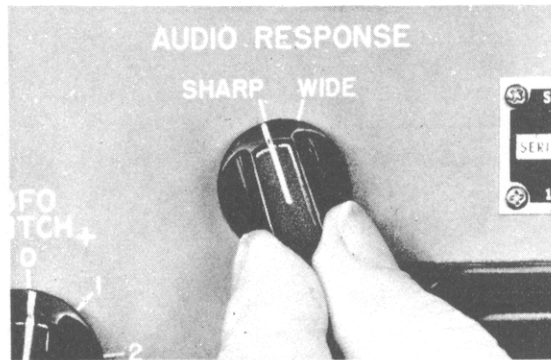

11 Turn the AUDIO RESPONSE switch to SHARP.

TM5820-358-10-17 (2)

Figure 11(2). Mcw or cw reception (part 2 of 2).

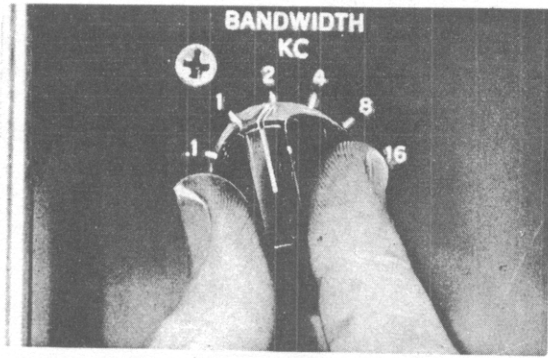

1 Turn the BANDWIDTH switch to 2. (For filter-type equipment, such as Radioteletype Terminal Equipment AN/FGC-1, where audio frequencies of 2,125 and 2,975 cps are used, turn the BANDWIDTH switch to 4.)

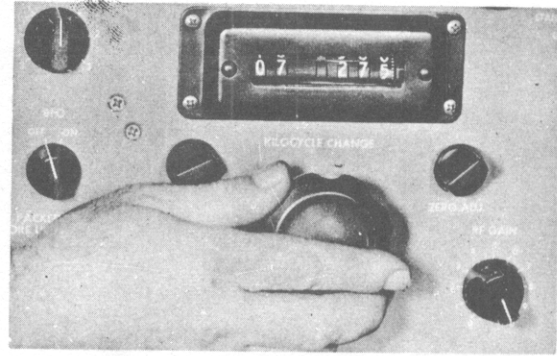

3 Tune the KILOCYCLE CHANGE control to the desired frequency; then readjust it slightly until mark and space signals with the same tone are heard.

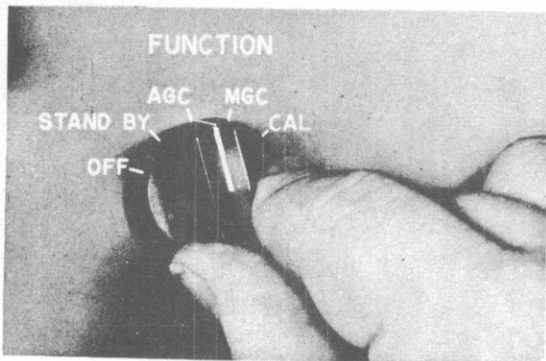

2 Turn the FUNCTION switch to AGC.

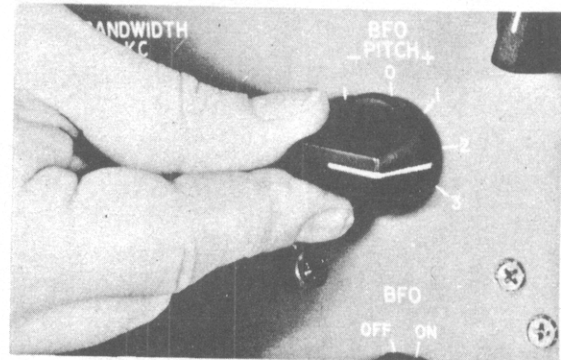

4 Adjust the BFO PITCH control until the teletypewriter prints good copy.

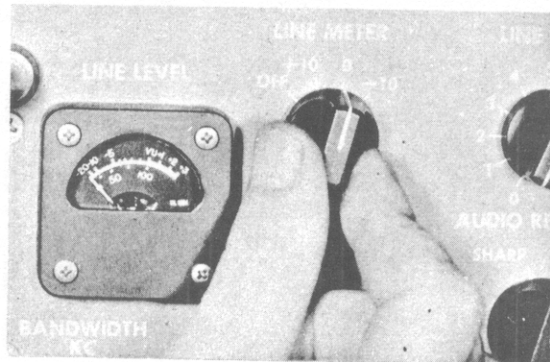

5 Turn the LINE METER switch to 0.

TM 5820-358-10-18 ①

Figure 12①. Reception of frequency-shift signals (part 1 of 2).

24

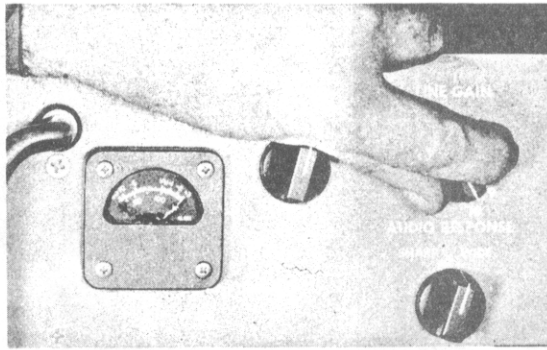

6 Turn the **LINE GAIN** control to 10. The **LINE LEVEL** meter should deflect fully to the right.

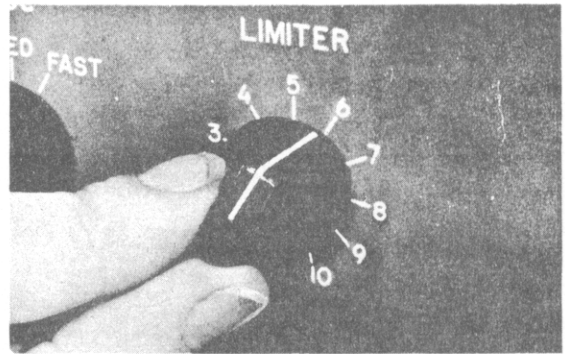
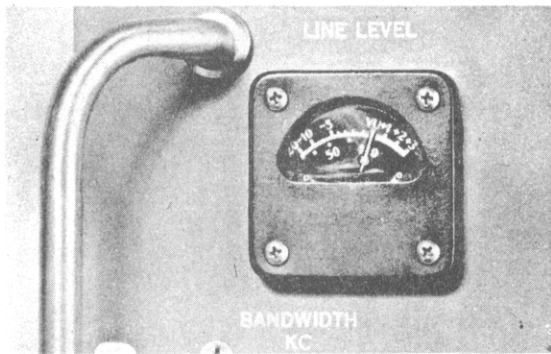

7 Adjust the **LIMITER** control for a **LINE LEVEL** meter indication at the **VU** mark.

TM5820-358-10-16 ②

Figure 12②. Reception of frequency-shift signals (part 2 of 2).

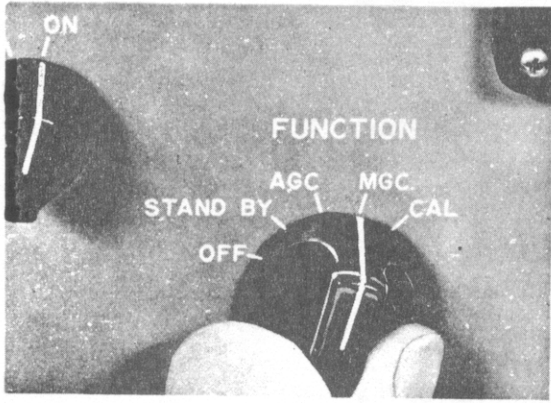

1 Turn the FUNCTION switch to MGC.

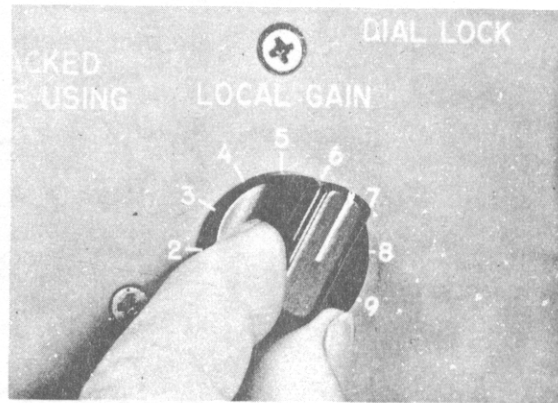

3 Turn the LOCAL GAIN control to 6.

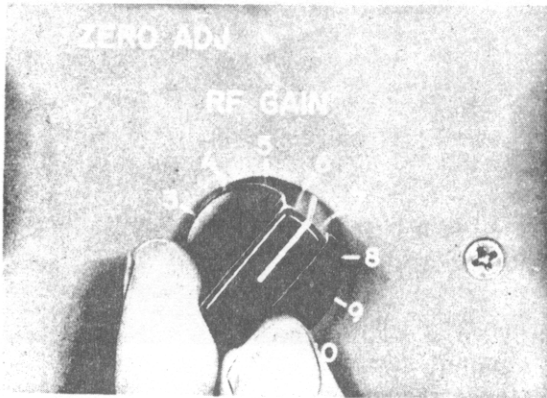

2 Turn the RF GAIN control to 6.

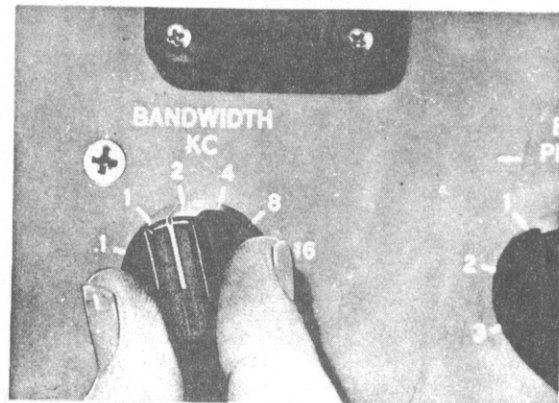

4 Turn the BANDWIDTH switch to 2 for a 2-kc bandwidth, or to 4 for a 4-kc bandwidth.

TM 5820-358-10-19 ①

Figure 13①. Single-sideband reception (part 1 of 2).

26

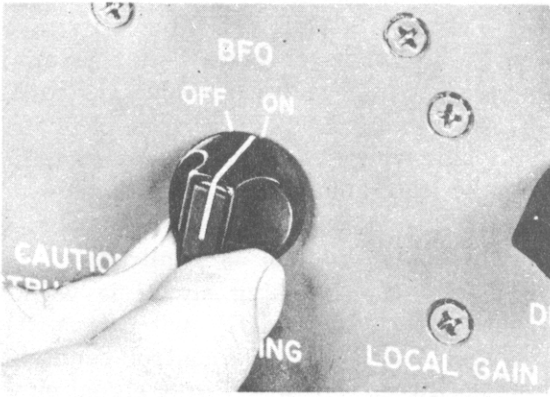

5 Turn the BFO switch to ON.

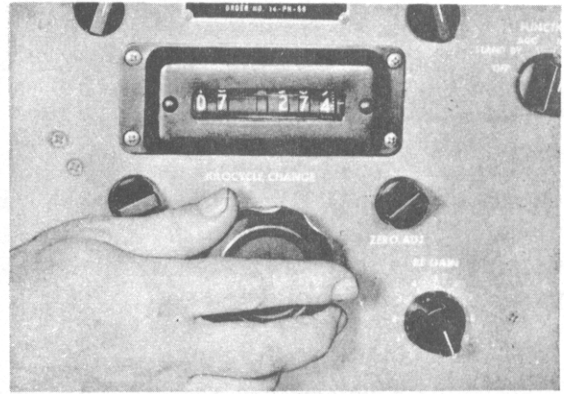

7 Tune the KILOCYCLE CHANGE control to the carrier frequency +1 kc for a 2-kc bandwidth, or +2 kc for a 4-kc bandwidth if the upper sideband is used (-1 kc or -2 kc respectively if the lower sideband is used).

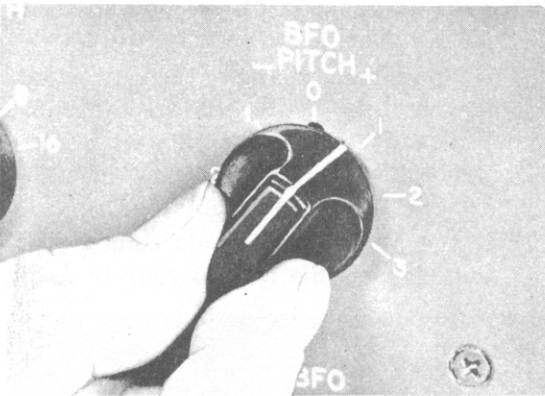

6 Set the BFO PITCH control at -1 for upper sideband reception with a signal 2-kc wide, or -2 for a 4-kc signal width (+1 or +2 respectively for lower sideband reception).

8 Adjust the BFO PITCH and/or KILOCYCLE CHANGE control slightly for the most intelligible reception (steps 6 and 7).

9 Adjust the LOCAL GAIN and RF GAIN controls for the desired audio level (steps 2 and 3).

TM 5820-358-10-19 (2)

Figure 13(2). Single-sideband reception (part 2 of 2).

17. Stopping Procedure

When the receiver is not to be used but is to be maintained in a state of readiness, turn the FUNCTION switch to STAND BY.

Caution: The FUNCTION switch should not be left in STAND BY for more than 30 minutes. Under this condition, the life of certain vacuum tubes may be shortened. For stopping procedure, refer to figure 14.

18. Antijamming Instructions

When it is determined that the receiver is being jammed, promptly inform your immediate superior officer. To provide maximum intelligibility of jammed signals, use the procedures given for each type of operation.

a. When receiving jammed voice signals, follow the procedures in the order indicated below until the signal is heard with the least amount of interference.

- (1) Turn the KILOCYCLE CHANGE control very slowly through several dial markings on either side of the desired signal. Some separation of the desired signal from the jamming signal may be achieved.

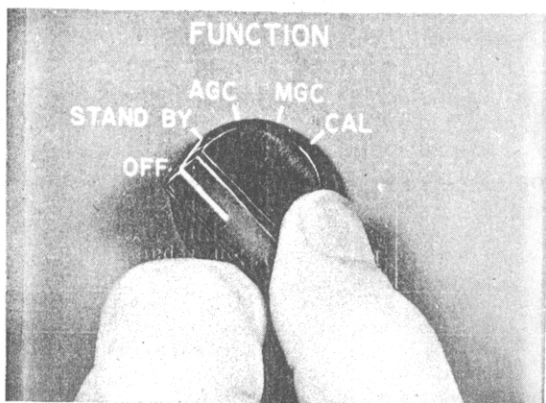

- 1** When the receiver is not to be used but is to be maintained in a state of instant readiness, turn the FUNCTION switch to STAND BY.

Caution: Do not leave the FUNCTION switch in STAND BY for more than 30 minutes, because the life of certain vacuum tubes may be shortened.

- (2) Turn the BANDWIDTH switch to 4 or 2, whichever gives better results. Slowly tune as described in (1) above.
- (3) Adjust the ANT TRIM control to the point where the signal is heard with the least amount of interference.
- (4) If the noise is severe, adjust the LIMITER control as required.
- (5) When the jamming signal is weak, turn the FUNCTION switch to MGC and the RF GAIN control counter-clockwise. The interfering signal may be reduced enough to permit the desired signal to come through.
- (6) If these steps do not provide a readable signal, request a change of frequency and call sign.
- (7) Request the use of cw operation, if permissible (b below).
- (8) If possible, change the direction, length, and height of the antenna. This may reduce the jamming effectiveness so that some degree of satisfactory reception is obtained.
- (9) If the jamming prevents communication, report this fact to your immedi-

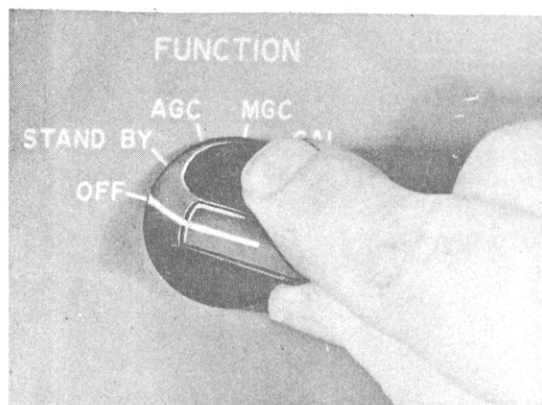

- 2** To shut the receiver off, turn the FUNCTION switch to OFF.

TM 5820-358-10-20

Figure 14. Stopping procedure.

ate superior. Keep your receiver tuned to the desired signal; continue to operate.

b. When receiving jammed cw or mcw signals, follow the procedures in the order indicated below until satisfactory reception is established.

- (1) Turn the KILOCYCLE CHANGE control very slowly through a few dial markings on either side of the desired signal. Some separation of the desired signal from the jamming may be achieved.

- (2) Turn the BANDWIDTH switch to 1 or .1 and turn the AUDIO RESPONSE switch to SHARP. Slowly tune as described in (1) above.

- (3) Reset the BFO PITCH control; it may be possible to separate the tone of the desired signal from the jamming signal to provide readability.

- (4) Perform the procedures indicated in a(3) through (6), (8), and (9) above.

c. When receiving frequency-shift signals, refer to the technical manual on the particular receiving system for antijamming instructions.

29

CHAPTER 3

MAINTENANCE INSTRUCTIONS

19. Scope of Operator's Maintenance

a. The following is a list of maintenance duties normally performed by the operator of Radio Receiver R-390A/URR. These procedures do not require special tools or test equipment.

b. Operator's maintenance for Radio Receiver R-390A/URR consists of the following:

- (1) Preventive maintenance (para 20).
- (2) Visual inspection (para 22).
- (3) Operational check (para 23).
- (4) Replacement of defective fuses (para 21).

20. Preventive Maintenance

a. *DA Form 11-238*. DA Form 11-238 (fig. 15) is a preventive maintenance checklist to be used by the operator. Items not applicable to the receiver are lined out in the figure. References in the ITEM block in the figure are to paragraphs that contain additional maintenance information pertinent to the particular item. Instructions for the use of the form appear on the form.

b. *Items*. The information shown in the chart below is supplementary to DA Form 11-238. The item numbers correspond to the ITEM numbers on the form.

Item	Maintenance procedures
2	Use a clean cloth to remove dust, dirt, moisture, and grease from the exteriors of cases, racks, mounts, transmission lines, headsets, and front panel controls. If necessary, wet the cloth with Cleaning Compound (Federal stock No. 7930-395-9542) and then wipe the parts with a dry clean cloth.
3	All control knobs should work smoothly, be tight on the shaft, and should not bind. Tighten all loose knobs and be sure that the knobs do not rub against the panel.
7	Report to the higher echelon repairman any cut, worn, or broken cables, wires, or transmission lines.

Warning: Cleaning compound is flammable and its fumes are toxic. Do not use near a flame; provide adequate ventilation.

21. Checking Fuses (fig. 7)

a. Remove the fuses from the rear panel. See that they are of the proper value. If the receiver is to be operated from a 115-volt source with the OVENS switch at OFF, replace the AC 3 AMP fuse with a 2-ampere fuse. If the receiver is to be operated from a 230-volt source with the OVENS switch at ON, use a 1½-ampere fuse; use a 1-ampere fuse with the OVENS switch at OFF.

Note. Receivers bearing Order No. 14-Phila-56, serial numbers 2683 and above, and Order No. 14385-Phila-58 have a ½-ampere and a ¼-ampere fuse on the rear panel in addition to the AC 3 AMP fuse.

b. If you replace a burned-out fuse with a new one and the new fuse burns out, notify a higher echelon repairman.

Caution: To avoid serious damage to the receiver, do not use any fuse other than the value specified.

22. Visual Inspection

a. When the equipment fails to perform properly, turn the power off and check all the items listed below. *Do not check any item with the power on.*

- (1) Wrong settings of switches and controls (para 9 and 10).
- (2) Cables, headset cord, or antenna lead-in wire improperly connected.
- (3) Disconnected cables, plugs, or headset cord.
- (4) Grounded or broken antenna lead-in wire.
- (5) Burned-out fuses (usually indicate some other faults) (para 21).

b. If the above checks do not locate the trouble, proceed to the operational checklist (para 23).

23. Operational Checklist

a. *General.* The operational checklist will help the operator to locate trouble quickly. The corrective measures are used to repair this

30

LEGEND for marking conditions: Satisfactory, ✓ Adjustment, Repair or Replacement required, X. Defect corrected, ⊗.		DAILY CONDITION FOR MONTH OF JULY 1960																
		1	2	3	4	5	6	7	8	9	10	11	12	13	14	15	16	
NO.	DAILY ITEM	17	18	19	20	21	22	23	24	25	26	27	28	29	30	31		
1.	COMPLETENESS AND GENERAL CONDITION OF EQUIPMENT. (Transmitters, receivers, carrying cases, wire, cables, microphones, tubes, speaker-pans, technical manuals).	✓	✓	✓	✓	✓	✓	✓	✓	✓	✓	✓	✓	✓	✓	✓		
2.	CLEAN DIRT AND MOISTURE FROM ANTENNA, HEADSETS, JACKS, PLUGS, COMPONENT PANELS.	✓	✓	✓	✓	✓	✓	✓	✓	✓	✓	✓	✓	✓	✓	✓		
3.	INSPECT CONTROLS FOR NORMAL OPERATION. TAP CONTROLS LIGHTLY FOR EVIDENCE OF CUT-OUT FROM LOOSE CONTACTS.	✓	✓	✓	✓	✓	✓	✓	✓	✓	✓	✓	✓	✓	✓	✓		
4.	CHECK FOR NORMAL OPERATION OF EQUIPMENT. BE ALERT FOR UNUSUAL OPERATION OR CONDITION.	✓	✓	✓	✓	✓	✓	✓	✓	✓	✓	✓	✓	✓	✓	✓		
WEEKLY		ADDITIONAL ITEMS FOR 2D AND 3D ECHELON INSPECTIONS																
		1ST	2D	3D	4TH	5TH	8TH	ECH									CONDITION	
5.	CLEAN AND TIGHTEN EXTERIORS OF CASES, RACKS, MOUNTS, TRANSMISSION LINES.	✓															CONDITION	
6.	INSPECT CASES, MOUNTS, WINDINGS AND EXPOSED METAL SURFACES FOR RUST, CORROSION.	✓															CONDITION	
7.	INSPECT CORDS, CABLE, WIRE, SHOCK MOUNTS FOR CUTS, KINKS, BREAKS, FRAYING, UNDUE STRAIN.	✓															CONDITION	
8.	INSPECT ANTENNA, HEADSET, JACKS, PLUGS, COMPONENT PANELS.																CONDITION	
9.	INSPECT SWITCHES, KNOBS, JACKS, CONNECTORS, NAME PLATES, DIAL AND METER WINDOWS.																CONDITION	
10.	INSPECT ACCESSIBLE ITEMS FOR LOOSENESS: SWITCHES, KNOBS, JACKS, CONNECTORS, NAME PLATES, DIAL AND METER WINDOWS.																CONDITION	
11.	CLEAN AND/OR INSPECT ANTENNA, HEADSET, JACKS, PLUGS, COMPONENT PANELS.																CONDITION	
12.	INSPECT SWITCHES, KNOBS, JACKS, CONNECTORS, NAME PLATES, DIAL AND METER WINDOWS.																CONDITION	
ADDITIONAL ITEMS FOR 2D AND 3D ECHELON INSPECTIONS																		
13.	INSPECT SWITCHES, KNOBS, JACKS, CONNECTORS, NAME PLATES, DIAL AND METER WINDOWS.	ADDITIONAL ITEMS FOR 2D AND 3D ECHELON INSPECTIONS																
14.	INSPECT SWITCHES, KNOBS, JACKS, CONNECTORS, NAME PLATES, DIAL AND METER WINDOWS.	ADDITIONAL ITEMS FOR 2D AND 3D ECHELON INSPECTIONS																

CONTINUED ON PAGE 4

Figure 15. DA FORM 11-238, pages 2 and 3.

trouble. If the measures suggested do not restore normal operation, troubleshooting is required by a higher echelon repairman. Note on the repair tag what corrective measures were taken and how the equipment performed at the time of failure.

b. Procedure. Place the set in operation (para 13). After the equipment has had time to warm up, perform the steps shown in *c* below, in the order given. Observe the equipment operation and perform any corrective measures necessary.

c. Checklist

Action	Normal indication	Corrective measure
FUNCTION switch at AGC.	Dial lamps lighted.	Check power cord and fuses (para 21).
	Rushing noise or signal heard in headset.	Check headset cord and plug.
Turn MEGACYCLE CHANGE control to each band.	Proper numbers appear in frequency-indicator window.	Higher echelon repair required.
Tune KILOCYCLE CHANGE control to a desired station.	Desired station is heard.	Higher echelon repair required.
Adjust ANT TRIM control for a maximum indication on CARRIER LEVEL meter.	A maximum deflection of meter is obtained.	Higher echelon repair required.
Turn LOCAL GAIN control from minimum to maximum.	Volume at loudspeaker or headset will increase.	Higher echelon repair required.
Turn LINE GAIN control from minimum to maximum.	Output level to 600-ohm line or headset and LINE LEVEL meter will increase.	Higher echelon repair required.
Turn RF GAIN control from minimum to maximum.	Audio output and CARRIER LEVEL meter indication will increase.	Higher echelon repair required.
Turn FUNCTION switch to MGC.	With no signal being received, noise level should increase slightly and CARRIER LEVEL not indicate.	Higher echelon repair required.
Tune KILOCYCLE CHANGE control to several different signals with FUNCTION switch at AGC.	Output volume nearly constant.	Higher echelon repair required.
Turn FUNCTION switch to CAL and operate KILOCYCLE CHANGE control.	Deflection on CARRIER LEVEL meter at each 100 kc reading.	Higher echelon repair required.
Turn LIMITER control to the right.	Noise peaks are reduced in amplitude.	Higher echelon repair required.
Turn LINE METER switch to 0 and adjust LINE GAIN control for LINE LEVEL meter reading at VU mark.	LINE LEVEL meter reads at VU mark.	Higher echelon repair required.
LINE METER switch at -10.	LINE LEVEL meter reads completely to right.	Higher echelon repair required.
LINE METER switch at +10.	LINE LEVEL meter reads -10.	Higher echelon repair required.
LINE METER switch at OFF.	LINE LEVEL meter reads completely to left.	Higher echelon repair required.
Turn BFO switch to ON.		
Turn KILOCYCLE CHANGE control.	A whistle-like tone is heard as each station is tuned in.	Higher echelon repair required.
Turn BFO PITCH control.	The pitch of the tone changes.	Higher echelon repair required.

32

Action	Normal indication	Corrective measure
Turn BANDWIDTH KC switch to each position from 16 to .1.	Selectivity becomes sharper and noise decreases. Only low frequency audio tones are heard in the .1 position.	Higher echelon repair required.
Turn FUNCTION switch to STAND BY.	No noise or signal is heard, dial lamps remain lighted.	Higher echelon repair required.
Turn FUNCTION switch to OFF.	Dial lamps go out.	Higher echelon repair required.

CHAPTER 4

SHIPMENT AND LIMITED STORAGE AND DEMOLITION TO PREVENT ENEMY USE

Section I. SHIPMENT AND LIMITED STORAGE

24. Disassembly

The following instructions are recommended for preparing the receiver for transportation and storage:

- a. Disconnect the antenna lead-in cable.
- b. Remove all connections to the rear-panel terminal strips of the receiver.
- c. Unplug the headphone cord from the front panel PHONES jack.

d. Disconnect the power cable from the ac outlet. Wind the cable around the clips provided on the receiver rear panel.

25. Repacking for Shipment or Limited Storage

Repacking for shipment or limited storage is normally done at a higher echelon level.

Section II. DEMOLITION OF MATERIEL TO PREVENT ENEMY USE

26. Authority for Demolition

The receiver and its accessories will be demolished only upon the order of the commander. The destruction procedures outlined in paragraph 28 will be used to prevent the enemy from using or salvaging the equipment.

27. Methods of Destruction

Use any or all of the methods listed in *a* through *f* below to make the equipment completely useless.

a. *Smash.* Smash the controls, tuning mechanism, tubes, coils, switches, capacitors, transformers, filters, and meters; use sledges,

axes, handaxes, pickaxes, hammers, crowbars, or other heavy tools.

b. *Cut.* Cut the power cord, the antenna lead-in cable, and the headset cord; use an axe, a handaxe, or a machete.

c. *Burn.* Burn cords, cables, and manuals; use gasoline, kerosene, oil, flamethrowers, or incendiary grenades.

d. *Bend.* Bend the panel, the cabinet, and the main frame.

e. *Explosives.* If explosives are necessary, use firearms, grenades, or TNT.

f. *Disposal.* Bury or scatter the destroyed parts in slit trenches or foxholes, or throw them into streams.

APPENDIX I

REFERENCES

Following is a list of applicable references that are available to the operator of Radio Receiver R-390A/URR:

DA PAM 108-1 Index of Army Motion Pictures, Film Strips, Slides, and Phono Recordings.

DA PAM 310-4 Index of Technical Manuals, Technical Bulletins, Supply Bulletins, Lubrication Orders, and Modification Work Orders.

FM 21-5

FM 21-6

FM 21-30

SR 320-5

SR 320-50

TM 11-649

Military Training.

Techniques of Military Instruction.

Military Symbols.

Dictionary of United States Army Terms.

Authorized Abbreviations and Brevity Codes.

Radio Receiving Sets

AN/FRR-40 and

AN/FRR-41.

APPENDIX II
BASIC ISSUE ITEMS LIST
RADIO RECEIVER R-390A/URR

Section I. INTRODUCTION

1. Scope

a. This appendix lists items supplied for initial operation and for running spares. The list includes tools, accessories, parts, and material issued as *part of* the major end item. The list includes all items authorized for basic operator maintenance of the equipment. End items of equipment are issued on the basis of allowances prescribed in equipment authorization tables and other documents that are a basis for requisitioning.

b. The columns are as follows:

- (1) *Source, maintenance, and recoverability code.* Not used.
- (2) *Federal stock number.* This column lists the 11-digit Federal stock number.
- (3) *Designation by model.* Not used.
- (4) *Description.* Nomenclature or the standard item name and brief identifying data for each item are listed in this column. When requisitioning, enter the nomenclature and description on the requisition.
- (5) *Unit of issue.* The unit of issue is the supply term by which the individual item is counted for procurement, storage, requisitioning, allowance, and issue purposes.

(6) *Expendability.* Expendable items are indicated by the letter X; nonexpendable items are indicated by NX.

(7) *Quantity authorized.* Under "Items Comprising an Operable Equipment" the column lists the quantity of items supplied for the initial operation of the equipment. Under "Running Spares and Accessory Items" the quantities listed are those issued initially with the equipment as spare parts. The quantities are authorized to be kept on hand by the operator for maintenance of the equipment.

(8) *Illustrations.* The "Figure No." column lists the illustrations in which the items appear. The "Item No." column lists the reference designations that appear on the part in the equipment. These designations are also used on any illustrations of the equipment.

2. Critical Items

A zero slash (ϕ) in the "Description" column indicates items that are expected to fail during the first year or items that will make the equipment inoperative if they fail.

36

Section II. FUNCTIONAL PARTS LIST

(1) SOURCE MAINTENANCE AND RECOVERABILITY CODE	(2) FEDERAL STOCK NUMBER	(3) DESIGNATION BY MODEL	(4) DESCRIPTION	(5) UNIT OF ISSUE	(6) EXPENDABILITY	(7) QUANTITY AUTHORIZED	(8) ILLUSTRATIONS	
							FIGURE NO	ITEM NO
			ITEMS COMPRISING AN OPERABLE EQUIPMENT					
			RECEIVER RADIO R-390A/URR					
	5820-538-7555		RECEIVER RADIO R-390A/URR	ea	X	1	5	V605
	Ord thru AGC		TECHNICAL MANUAL TM 11-5920-358-10	ea	X	2	5	V504
			RUNNING SPARES AND ACCESSORY ITEMS					
			RECEIVER RADIO R-390A/URR					
	5960-188-3564		0 ELECTRON TUBE: MIL type 6A4	ea	X	1	5	V604
	5960-188-3551		0 ELECTRON TUBE: MIL type 6AK6	ea	X	1	5	V604
	5960-188-8515		0 ELECTRON TUBE: MIL type 6C4 Item Nos. V202, V203, V201, V606	ea	X	1	5	See descr column
	5960-548-5068		0 ELECTRON TUBE: MIL type 6DC6	ea	X	1	5	V201
	5960-262-0221		0 ELECTRON TUBE: MIL type 26Z7A	ea	X	1	5	V801
	5960-262-1357		0 ELECTRON TUBE: MIL type 5Y34 6AK5A	ea	X	1	5	V802
	5960-264-2089		0 ELECTRON TUBE: MIL type 5749 6B16M: (When V701 is replaced sub-assembly must be adjusted)	ea	X	2	5	V207
	5960-262-0210		0 ELECTRON TUBE: MIL type 5A14 Item Nos. V501, V502, V503, V505, V508, V701	ea	X	2	5	See desc column
	5920-010-6652		0 FUSE, CARTRIDGE: MIL type F02GR003 Item Nos. V205, V206, V506, V507, V509, V501, V602	ea	X	5	5	See desc column
	5920-543-0425		0 FUSE, CARTRIDGE: MIL type F02GR250B	ea	X	5	5	F101
	5920-356-2188		0 FUSE, CARTRIDGE: MIL type F02-R121A	ea	X	5	5	F102
	6240-155-7857		0 LAMP, INCANDESCENT: Fe-1 Spec No. W-L-11, trade No. 328; Collins part /dxy No. 369 0923 00	ea	X	1	5	F103
			0 LAMP, GLOW: Tfw, GE type No. NE-45 6210-179-1814 (Eng Stk No.)	ea	X	1	5	I102
	5905-502-4840		RESISTOR, CURRENT REGULATING MIL-TYPE TJ311M01	ea	X	1	5	I103
				ea	X	1	5	RT510

R-390A/URR

TM 5820-358-10-21

By Order of *Wilber M. Brucker*, Secretary of the Army:

G. H. DECKER,
General, United States Army,
Chief of Staff.

Official:

R. V. LEE,
Major General, United States Army,
The Adjutant General.

Distribution:

Active Army:

To be distributed in accordance with DA Form 12-7 requirements for TM 11 Series (UNCL) plus the following formula:

USASA (2)	11-57
CNGB (1)	11-85
Tech Stf, DA (1) except CSigO (18)	11-86
DASA (5)	11-98
US ARADCOM (2)	11-117
US ARADCOM Rgn (2)	11-155
MDW (1)	11-500 (AA-AE) (4)
Seventh US Army (2)	11-557
EUSA (2)	11-587
Units org under fol TOE: (2 copies each except as inde)	11-592
11-7	11-597
11-16	32-51
11-32	32-56
	32-57

NG: State AG (3); Units — Same as Active Army except allowance is one copy for each unit.

USAR: None.

For explanation of abbreviations used, see AR 320-50.

NAVSEEACT 13/17ND
LIBRARY

NAVSEEA CT 13/17ND
LIBRARY