

**INSTRUCTION BOOK**

**FOR**

**RADIO RECEIVER BC-348-H**

**MANUFACTURED BY**

**BELMONT RADIO CORPORATION**

**CHICAGO, ILLINOIS, U. S. A.**



For Airplane Type **B25-C**  
AAF Serial No. **42-32379**

**RESTRICTED**

**PUBLISHED BY AUTHORITY**

**OF**

**THE CHIEF SIGNAL OFFICER**

**ORDER NO. 2356-CHI-41**

# INSTRUCTION BOOK

FOR

## RADIO RECEIVER BC-348-H

MANUFACTURED BY

BELMONT RADIO CORPORATION  
CHICAGO, ILLINOIS, U. S. A.

# RESTRICTED

**NOTICE:** This document contains information affecting the national defense of the United States within the meaning of the Espionage Act (U.S.C. 50:31,32). The transmission of this document or the revelation of its contents in any manner to any unauthorized person is prohibited.

The information contained in documents marked RESTRICTED will not be communicated to the public nor to the press, but it may be communicated to any person known to be in the service of the United States, and to persons of undoubted loyalty and discretion who are co-operating in governmental work. (AR 380-5).

PUBLISHED BY AUTHORITY  
OF  
THE CHIEF SIGNAL OFFICER

ORDER NO. 2356-CHI-41

## TABLE OF CONTENTS

	Page
Section I General Description of Complete Equipment.....	1
1 General . . . . .	1
2 Component Units . . . . .	1
3 Cabinet . . . . .	1
4 Chassis . . . . .	1
5 Panel . . . . .	1
6 Dial and Mask Assembly . . . . .	5
7 R-F and Oscillator Units . . . . .	5
8 I-F Transformers, Beat Frequency Oscillator and Crystal Filter . . . . .	5
9 Mounting FT-154-H . . . . .	5
10 Plug PL-P103 and Plug PL-Q103.....	5
11 Illumination . . . . .	5
Section II Employment . . . . .	6
12 Installation . . . . .	6
a Mounting . . . . .	6
b Power Connections . . . . .	6
c Transmitter Connections . . . . .	6
d Output Connections . . . . .	7
e Bonding and Shielding . . . . .	7
f Mounting of Receiver . . . . .	7
g Safety Wire . . . . .	7
h Ground . . . . .	7
i Antenna . . . . .	7
13 Preparation for Use . . . . .	7
14 Operation . . . . .	7
a Power Switch . . . . .	7
b Operating Test . . . . .	7
c Operating Routine . . . . .	8
Section III Detailed Functioning of Parts . . . . .	10
15 Circuits . . . . .	10
16 Frequency Range and Frequency Bands . . . . .	10
17 Input Coupling . . . . .	10
18 Input Protection . . . . .	10
19 Radio Frequency Amplifier . . . . .	10
20 First Detector . . . . .	10
21 Heterodyne Oscillator . . . . .	10
22 Intermediate Frequency Amplifier . . . . .	11

## TABLE OF CONTENTS—Continued

	Page
23 C-W Oscillator .....	11
24 Crystal Band-Pass Filter .....	12
25 Second Detector .....	12
26 Output . . . . .	12
a Description . . . . .	12
b Constant Internal Receiver Noise .....	13
27 Dynamotor DM-28-H .....	13
28 Characteristics of Tubes, Lamps, Voltage Regulator and Fuse.....	14
 Section IV Maintenance .....	 15
29 Inspection . . . . .	15
30 Care and Servicing Dynamotor DM-28-H.....	15
31 Removal of Front Panel .....	17
32 Dial and Mask Assembly .....	18
33 Removal and Replacement of Dial Mechanism .....	19
34 Removal of Antenna, R-F Detector and Oscillator Units .....	20
35 Trouble Location and Remedy .....	20
a General . . . . .	20
b Equipment Required .....	21
c Weak or No Signals on All Bands, Modulated Reception.....	22
d Weak or No Signals on Any One Band, Modulated Reception.....	27
e Weak or No Signals on All Bands, C-W Reception (Modulated Reception Normal) .....	27
f Measurements with Test Set I-56-A .....	30
g Failure of Dial Lights .....	32
 Section V Supplementary Data and List of Replaceable Parts.....	 33

## LIST OF ILLUSTRATIONS

	Page
Figure 1 Radio Receiver BC-348-H .....	viii
“ 2 Bottom and Back View of Cabinet Radio Receiver BC-348-H .....	2
“ 3 Mounting FT-154-H with Plug PL-P103 Attached .....	2
“ 4 Radio Receiver BC-348-H—Front View of Chassis with the Tube Shelf Cover Removed.....	3
“ 5 Radio Receiver BC-348-H—Top View of Chassis .....	3
“ 6 Radio Receiver BC-348-H—Bottom View of Chassis .....	4
“ 7 Radio Receiver BC-348-H—Rear View of Chassis .....	4
“ 8 Plug Connections .....	6
“ 9 C-W Oscillator Switching .....	11
“ 10 Details of Crystal Filter Circuit.....	12
“ 11 Load Compensator and Bleeder Circuit Diagram .....	13
“ 12 Dynamotor DM-28-H and View Showing Filter Open .....	16
“ 13 Dynamotor DM-28-H—Disassembled .....	17
“ 14 Trouble Location and Correction Chart .....	20
“ 15 Radio Receiver BC-348-H—Dynamotor and Tube Socket Voltages .....	21
“ 16 I-F Transformers, C-W Oscillator and Crystal Filter Assemblies .....	22
“ 17 Antenna Unit .....	23
“ 18 R-F Unit .....	24
“ 19 Detector Unit .....	25
“ 20 Oscillator Unit .....	26
“ 21 Radio Receiver BC-348-H—Resistor Boards View A .....	28
“ 22 Radio Receiver BC-348-H—Resistor Boards View B .....	28
“ 23 Radio Receiver BC-348-H—Schematic Circuit diagram .....	55
“ 24 Radio Receiver BC-348-H—Wiring Diagram.....	57
“ 25 Radio Receiver BC-348-H—Wiring Diagram, Tube Shelf .....	59
“ 26 Radio Receiver BC-348-H—Wiring Diagram, Antenna Unit .....	61
“ 27 Radio Receiver BC-348-H—Wiring Diagram, R-F Unit .....	63
“ 28 Radio Receiver BC-348-H—Wiring Diagram, Detector Unit .....	65
“ 29 Radio Receiver BC-348-H—Wiring Diagram, Oscillator Unit .....	67
“ 30 Radio Receiver BC-348-H—Wiring Diagram, I-F Transformers .....	69
“ 31 Radio Receiver BC-348-H—Wiring Diagram, Crystal Filter .....	71

## LIST OF ILLUSTRATIONS—Continued

	Page
Figure 32 Radio Receiver BC-348-H—Wiring Diagram, Beat Frequency Oscillator .....	73
“ 33 Radio Receiver BC-348-H—Wiring Diagram, Resistor Boards .....	75
“ 34 Radio Receiver BC-348-H—Wiring Diagram, Dynamotor Assembly .....	77
“ 35 Radio Receiver BC-348-H—Dial and Mask Assembly .....	79
“ 36 Radio Receiver BC-348-H—General View of Receiver .....	81
“ 37 Radio Receiver BC-348-H—Outline Dimensional Drawing .....	83
“ 38 Radio Receiver BC-348-H—Drilling Plan.....	85



FIGURE 1—RADIO RECEIVER BC-348-H

SECTION I

GENERAL DESCRIPTION OF COMPLETE EQUIPMENT

1 GENERAL

Radio Receiver BC-348-H is a locally controlled, 8-tube, 6-band superheterodyne receiver for use in U. S. Army aircraft and covers the frequency ranges of 200 to 500 kilocycles and 1.5 to 18.0 megacycles. The receiver is not intended for remote control, and no features or units have been provided for remote operation. This receiver is capable of voice, tone and c-w reception with manual or automatic volume control. The receiver, when equipped with tubes, dial lights and fuse, and with the antenna, ground, and primary power source connection properly made, becomes complete and operative equipment by the addition of headsets, as all coils and the high voltage power supply unit are built into the receiver. The total power consumed by the receiver is 56 watts.

2 COMPONENT UNITS

The following is a list of the component units of Radio Receiver BC-348-H:

	Size in Inches	Weight in Pounds
1 Radio Receiver BC-348-H (Includes Dynamotor DM-28-H and Mounting FT-154-H) .....	18 x 10 $\frac{1}{2}$ x 9 $\frac{1}{2}$	35.5
1 Mounting FT-154-H (Does not include Plug PL-P103 or PL-Q103) ..	18 x 8 $\frac{1}{2}$ x 1 $\frac{3}{8}$	3.81
1 { Plug PL-P103 .....	2 $\frac{5}{16}$ x 2 $\frac{5}{32}$ x 1 $\frac{9}{16}$	.34
or		
1 { Plug PL-Q103 .....	3 x 2 $\frac{5}{32}$ x 2 $\frac{1}{16}$	.41
1 Tube VT-152 .....	3 $\frac{5}{16}$ x 1 $\frac{5}{16}$ dia.	.07
1 Tube VT-65 .....	2 $\frac{5}{8}$ x 1 $\frac{5}{16}$ dia.	.08
1 Tube VT-70 .....	4 $\frac{1}{2}$ x 1 $\frac{9}{16}$ dia.	.09
3 Tube VT-86 .....	3 $\frac{1}{8}$ x 1 $\frac{5}{16}$ dia.	.08
1 Tube VT-91 .....	3 $\frac{1}{8}$ x 1 $\frac{5}{16}$ dia.	.09
1 Tube VT-93 .....	3 $\frac{1}{8}$ x 1 $\frac{5}{16}$ dia.	.09
2 Lamps LM-27 .....	1 $\frac{1}{8}$ x $\frac{1}{2}$ dia.	.01
1 Voltage Regulator Type 991 .....	1 $\frac{1}{2}$ x $\frac{11}{16}$ dia.	.02
1 Fuse FU-35 .....	1 $\frac{1}{4}$ x $\frac{1}{4}$ dia.	.01

3 CABINET

The receiver cabinet is of spot-welded aluminum construction with black wrinkle finish and is em-

bossed on the top and back to add rigidity and strength. The panel (front) end allows the removal of the receiver chassis, which runs on the stainless steel strips mounted in the end corners of the cabinet. Two tapped inserts are placed in the rear to receive the thumb screw rods which secure the chassis in the cabinet. A cutout in the rear bottom permits the entrance of Plug PL-P103 or PL-Q103. An aluminum casting is mounted over this cutout and acts as a seal between the cabinet and the chassis. The bottom of the cabinet is reinforced by a stainless steel plate to which are attached the four mounting studs for securing the cabinet to Mounting FT-154-H. Two snap slides are mounted on the downward projection of the front of the stainless steel plate. A phosphor bronze spring clip is riveted to the rear inside face of the cabinet, providing a firm electrical connection between the cabinet and chassis. This connection acts as a low resistance shorting path for circulating ground currents, thus preventing electrical interference from the dynamotor unit from reaching the input circuits of the receiver.

4 CHASSIS

The chassis consists of an aluminum casting mounted between two end plates of sheet aluminum, which serve as runners and guides when placing the chassis in the cabinet. The end plates are provided with cutouts to facilitate servicing.

5 PANEL

The front panel is attached to the chassis and to the end plates by screws. Two handles are mounted on the panel, and two thumb screw rods which secure the chassis in the cabinet pass through the lower part of these handles. A cutout, covered by a plate, is provided to give access to the wiring under the r-f tube shelf for servicing and maintenance. The following panel items are mounted on the front of the panel:

Antenna and ground binding posts; antenna alignment control; dial lights rheostat control; tuning control; band switch control; dial window housing which covers the dial lights; beat frequency control; crystal filter control; volume control; "AVC-OFF-MVC" control; "C.W. OSC." control; and two telephone jacks.



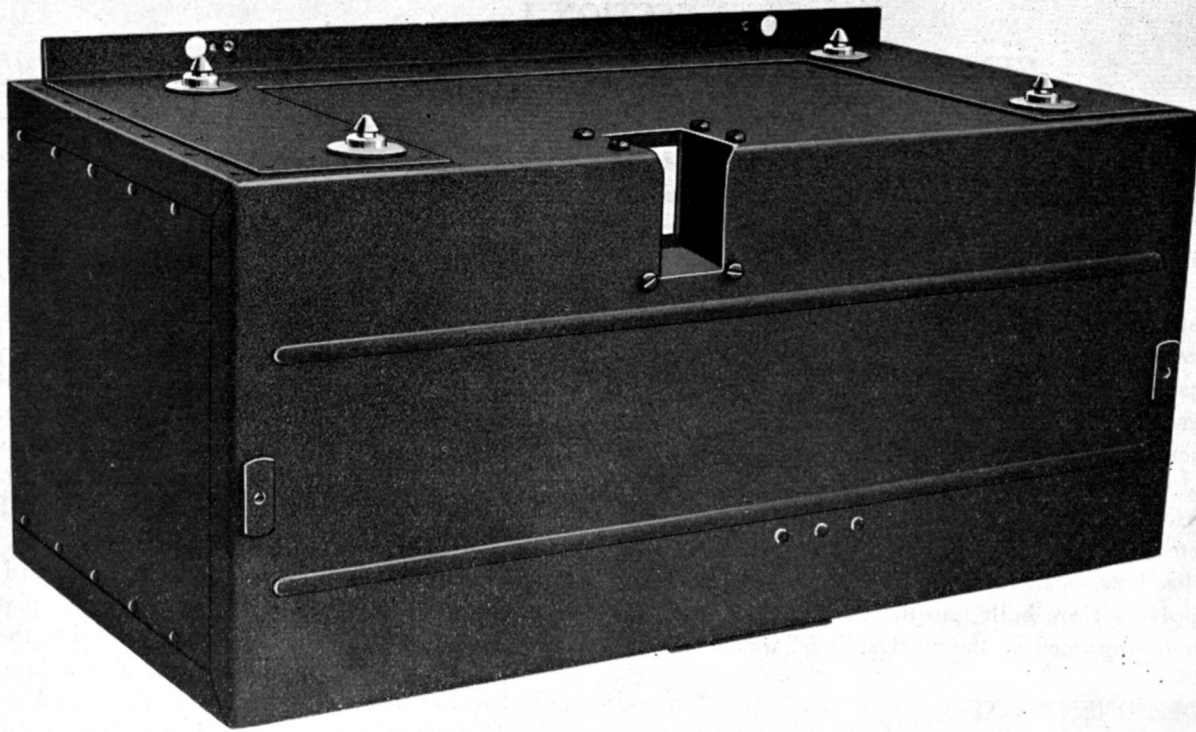

FIGURE 2—BOTTOM AND BACK VIEW OF CABINET RADIO RECEIVER BC-348-H

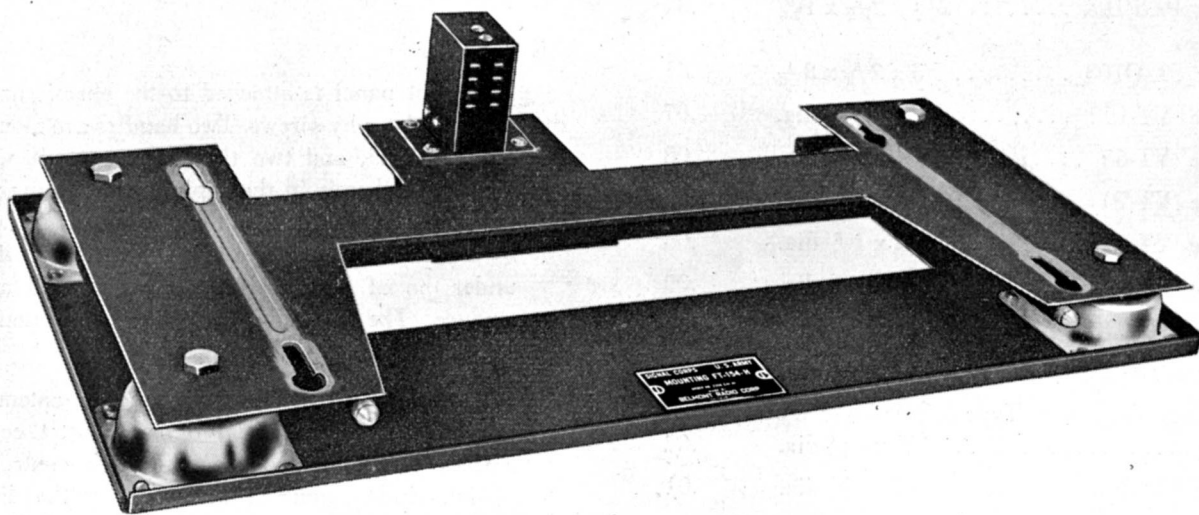

FIGURE 3—MOUNTING FT-154-H WITH PLUG PL-P103 ATTACHED

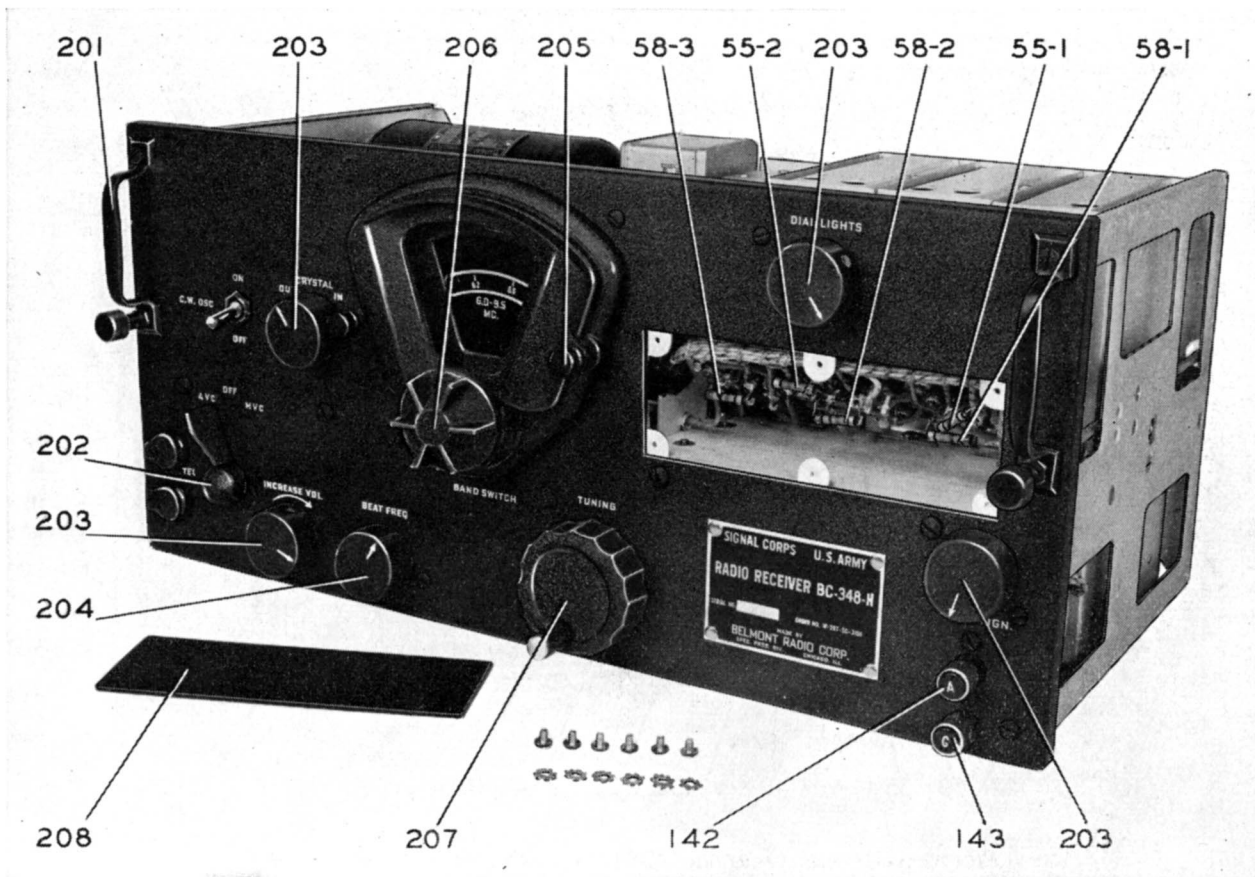

FIGURE 4—RADIO RECEIVER BC-348-H: FRONT VIEW OF CHASSIS WITH THE TUBE SHELF COVER REMOVED

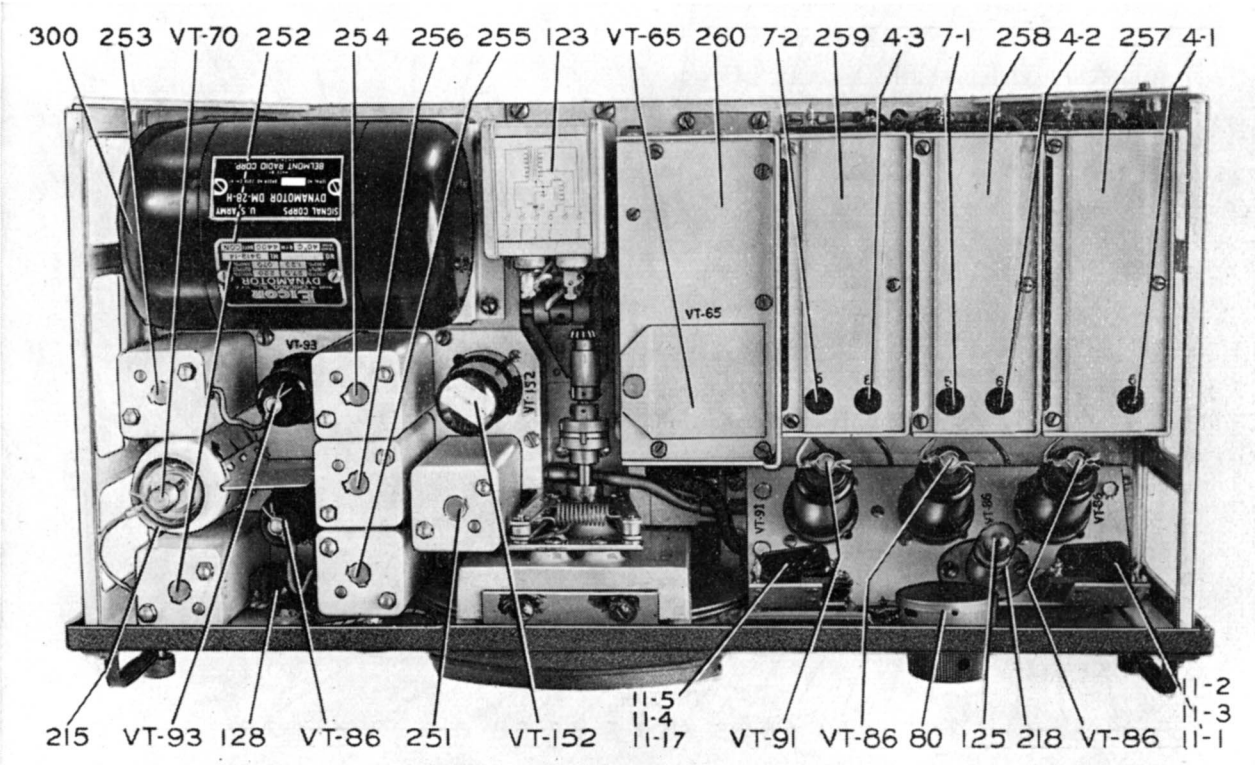

FIGURE 5—RADIO RECEIVER BC-348-H: TOP VIEW OF CHASSIS

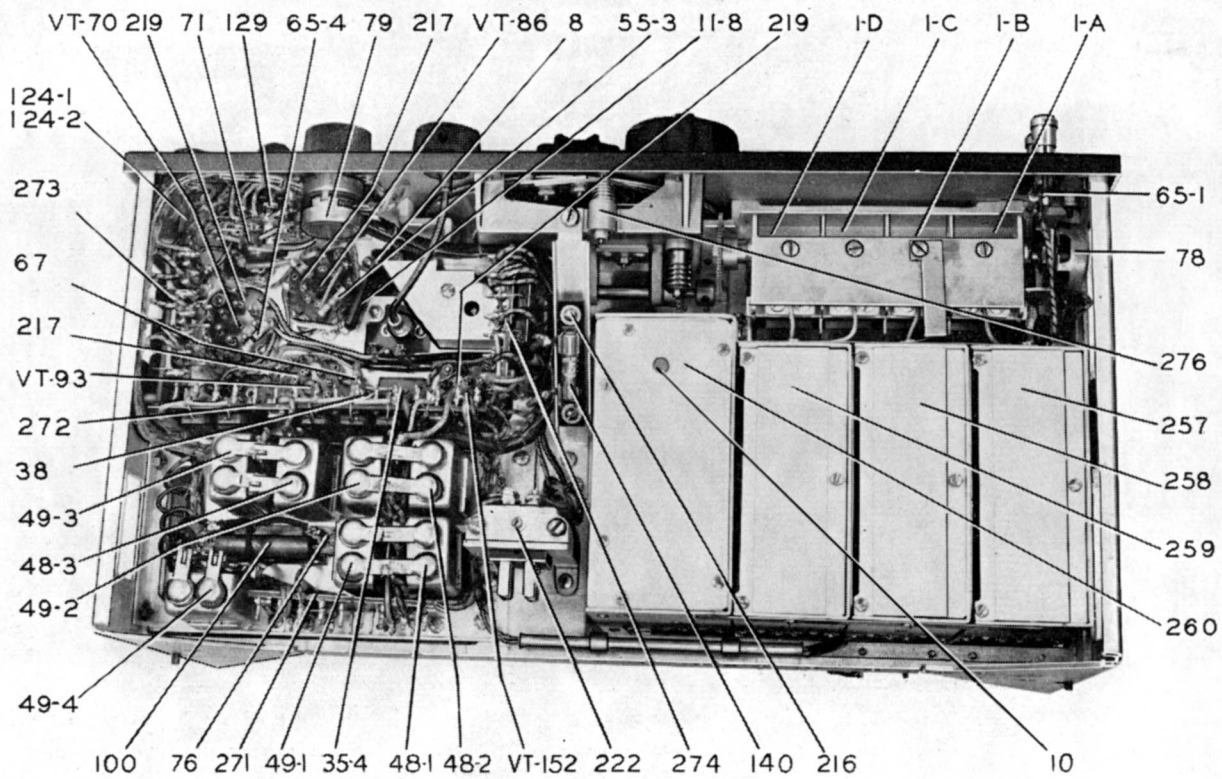

FIGURE 6—RADIO RECEIVER BC-348-H: BOTTOM VIEW OF CHASSIS

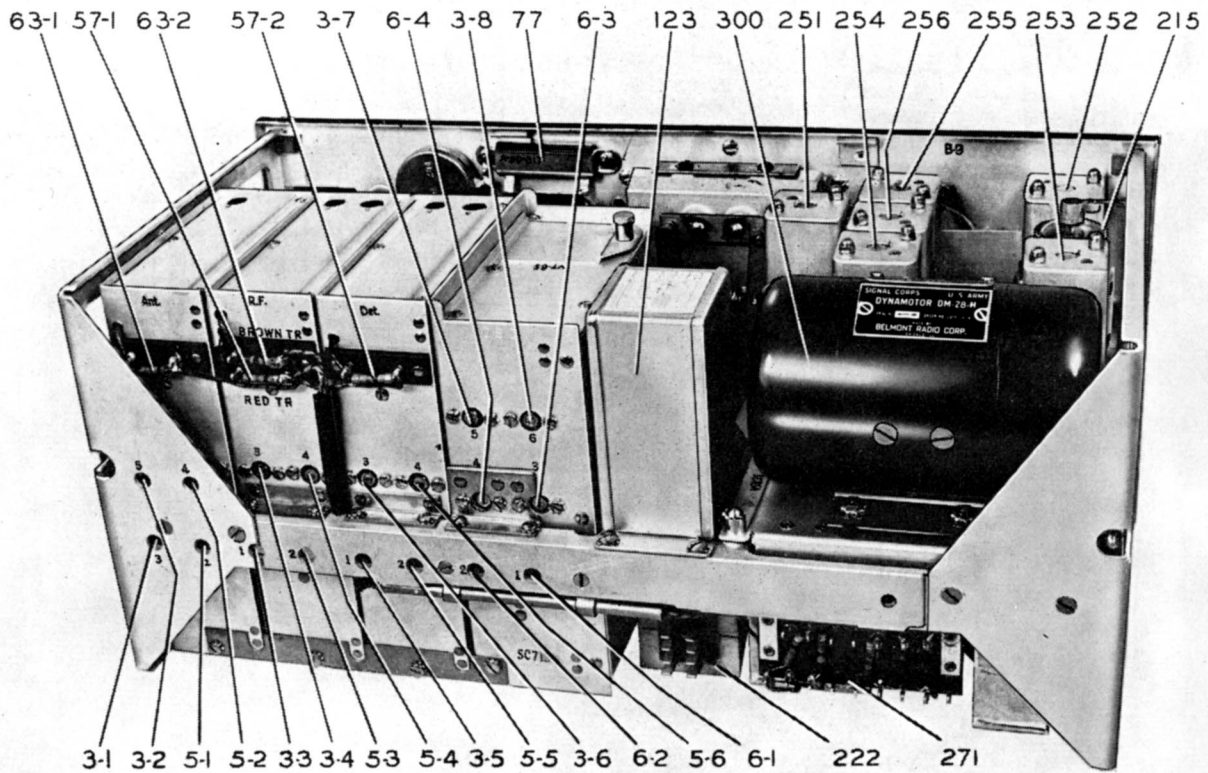

FIGURE 7—RADIO RECEIVER BC-348-H: REAR VIEW OF CHASSIS

## 6 DIAL AND MASK ASSEMBLY

The dial and mask assembly is mounted on an aluminum casting which carries the gearing of the tuning condenser drive and the detent. This unit is attached to the front panel and connects to the band switch drive shaft through a coupling of the Oldham type. The dial is divided into six frequency bands, and the dial and tuning condenser are so geared to the tuning control shaft that the tuning condenser covers the frequency range indicated on the dial for each band in approximately 90 revolutions of the tuning knob. Split gearing is used throughout to minimize backlash. A positive stop is provided to prevent undue pressure on the gears and to limit the travel of the dial and the tuning condenser.

A mask with suitably located and marked windows, is mounted before the dial. The mask is controlled by the band change switch and is positioned by the detent.

## 7 R-F AND OSCILLATOR UNITS

The antenna, r-f, 1st detector and oscillator sub-assemblies are mounted on the right rear portion of the chassis. Each sub-assembly consists of the r-f coils, trimmers and band switch wafers with the necessary fixed capacitors and resistors. Passing through all of these sub-assemblies is the band switch drive shaft which is pulled out from the right end of the receiver chassis before a sub-assembly is removed.

## 8 I-F TRANSFORMERS, BEAT FREQUENCY OSCILLATOR AND CRYSTAL FILTER

These units are mounted on the left front portion of the chassis. The variable capacitor of the Beat

Frequency Oscillator is controlled through a flexible shaft from the front panel.

## 9 MOUNTING FT-154-H

The mounting is constructed of stainless steel except for the aluminum base which carries the mounting holes and to which are attached the bases of four shock absorbers. To the top of the shock absorbers is fastened the stainless steel support, which provides for the attachment of the receiver cabinet by means of studs and snapslides. Grooves are provided in the stainless steel support to facilitate the engagement of the studs of the cabinet with the mounting.

## 10 PLUG PL-P103 AND PLUG PL-Q103

The plug, attached to the mounting by screws, is provided with eight terminals which are accessible upon removal of the rear cover of the plug housing. The plug, when provided with a straight outlet, becomes Plug PL-P103. A right angle outlet which may be mounted in any of three positions, right, left or back may be used with the plug, making it Plug PL-Q103. The positions and uses of these outlets with the plug are clearly shown on the outline dimensional drawing in Section V (Fig. 37).

## 11 ILLUMINATION

The receiver tuning dial is illuminated by means of two dial lights (Lamps LM-27) controlled by the "DIAL LIGHTS" rheostat. This rheostat has an off position when the illumination is not desired. The dial lights are located beneath a readily removable housing which permits the easy replacement of a dial lamp during flight.

## SECTION II EMPLOYMENT

### 12 INSTALLATION

The most important considerations necessary for the successful installation and operation of this receiver are as follows:

#### a Mounting

The receiver should be mounted on a plane surface with sufficient clearance allowed on all sides to permit free action of the shock absorber mounting. The mounting should be permanently attached to the rigid members of the plane. The drilling plan of the mounting is shown in Section V (FIGURE 38).

#### b Power Connections

The leads to the primary power source are connected as shown in FIGURE 8. The parallel connected leads from plug terminals 3 and 4 may be

replaced by a single conductor of cross section equivalent to the two separate leads. Similarly, the parallel connected leads from plug terminals 7 and 8 may be replaced by a single conductor of equivalent cross sectional area. The power source to which these leads are connected should be 28 volts.

#### c Transmitter Connections

Provisions have been made for the protection of this receiver when the associated transmitter is being used. Leads from plug terminals 2 and 6 should be wired to contacts on the transmitter relay. If the transmitter is removed from the installation, or if the receiver is being installed without an associated transmitter, the wires from plug terminals 2 and 6 must be connected together to have the receiver operate.

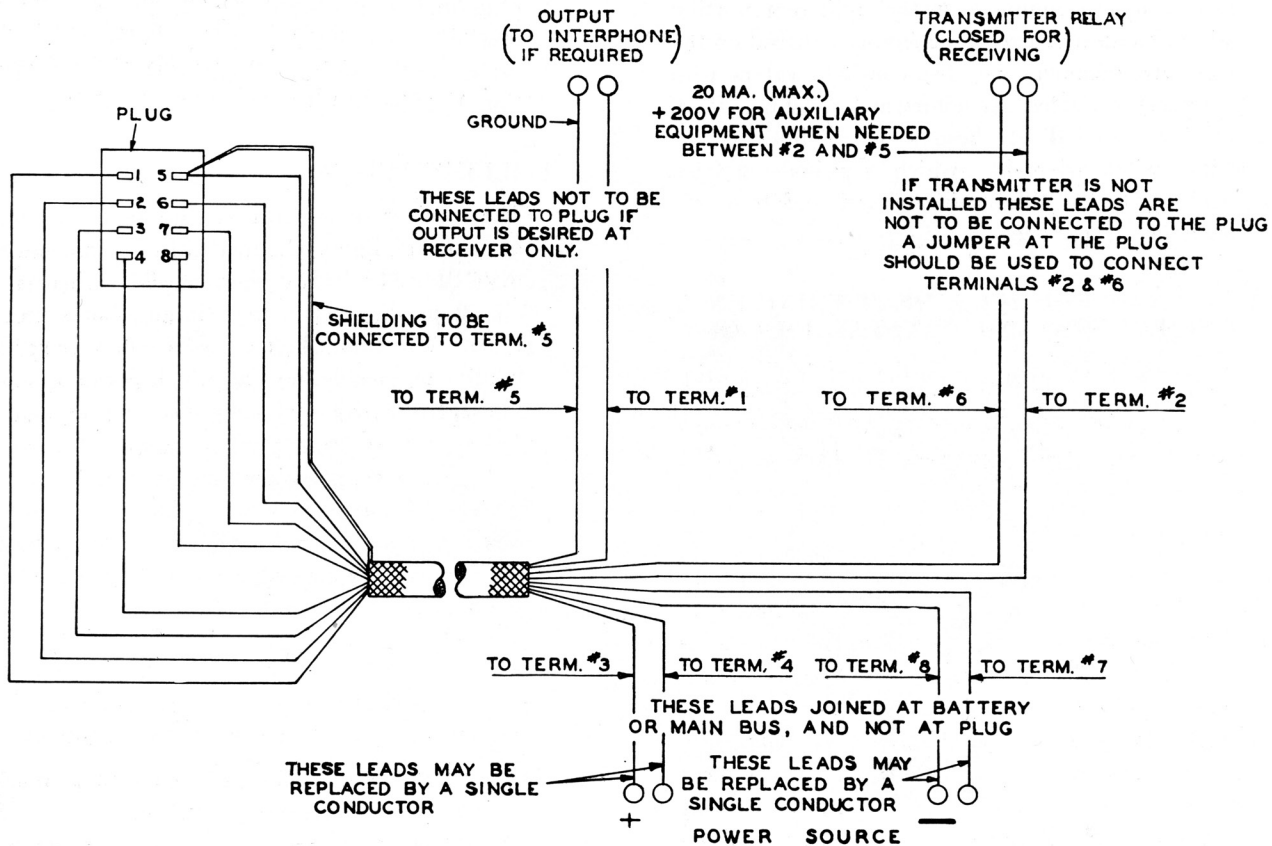

FIGURE 8—PLUG CONNECTIONS

*d Output Connections*

The output of this receiver has been brought to plug terminals 1 and 5 and to the two front-panel jacks. Leads from these terminals should be wired to the Interphone System or as otherwise desired. If the output is desired only at the receiver, it should be taken directly from the phone jacks and no connections made to plug terminals 1 and 5.

*e Bonding and Shielding*

At the time of installation of this equipment, care should be taken to insure that the engine ignition system, generator, and other possible causes of disturbance are properly shielded and that bonding of metal parts is, or has been, carefully carried out.

*f Mounting of Receiver*

When proper wiring connections have been made, place the receiver on its mounting with the studs on the bottom of the cabinet entering the slots of the mounting. See that the cabinet is well down on the mounting and that all four studs are fully seated, then push the cabinet towards the rear and secure in place by the snapslides on the lower front corners of the cabinet.

*g Safety Wire*

Safety wire should be passed through the holes of the snapslide assemblies, care being taken that the wires are not twisted too tightly.

*h Ground*

The ground binding post "G" should be connected by a short, direct, low resistance lead to some grounded metal portion of the plane and soldered at that point, if practicable. The lead should have enough slack to prevent vibration being transmitted to the receiver.

*i Antenna*

The antenna circuit aligning capacitor is such that the antenna circuit can be properly aligned when using antennas that range in effective capacitance from 50 to 200 micromicrofarads. However, satisfactory performance will be obtained on practically any type of mast, fixed, or trailing wire antenna, although in extreme cases, i.e., very short mast or very long trailing wire, optimum setting of the antenna alignment control may not be obtained. In general, the most effective antenna is one whose length away from the grounded metal fuselage is the greatest. The receiver should be

located as near as possible to the lead-in insulator and connected from the insulator to the antenna binding post "A" by a copper wire. The lead should have enough slack to prevent vibration being transmitted to the receiver.

**13 PREPARATION FOR USE**

This receiver is a self-contained unit, having its high voltage power supply and all coil sets built in. *Before installing the tubes, they should be checked with the required tube checker. Be sure that the proper tubes, well pushed down and firmly seated in their sockets, are installed, that the tube shield is properly seated, and that grid caps fit tightly on the tubes.* Check dial lights and fuse and see that they are properly and securely placed. Make sure that the leads to the dynamotor unit are properly connected at the dynamotor terminal strip and that the screws holding them in place are tight. With the receiver "AVC-OFF-MVC" switch, in the "MVC" position and the band switch on Band 1 by means of the tuning control, tune in a signal at approximately 500 kilocycles, to maximum signal strength. Reduce volume by means of volume control knob until signal is just audible. Adjust the antenna alignment control to give maximum volume.

**14 OPERATION**

*a Power Switch*

Power to the receiver is controlled by the receiver "AVC-OFF-MVC" switch. With this switch in the "OFF" position, no power is supplied to the receiver. When switched to either the "MVC" or "AVC" position, power from the primary source is supplied to the tube heaters and dynamotor placing the equipment in operation. The screen grid voltage supply leads are carried out of the receiver through the power plug to the keying relay of the associated transmitter where the circuit is opened when actually transmitting. (Refer to Par. 12c).

*b Operating Test*

When the receiver has been completely installed, an operating test should be made as follows:

- (1) Plug a headset into one of the jacks marked "TEL." Set receiver switch to "MVC." The dynamotor should start, and, after the tubes have warmed up (approximately 30 seconds), the volume control knob should be advanced until a slight background noise is

## Par. 14

heard. Set band switch to the frequency band in which test signals are available.

- (2) Using the tuning knob and with reference to the calibrated scale on the dial, tune in the desired signal. *Note: All tuning should be done on "MVC" with the volume control advanced only enough to give the desired signal strength. In the absence of a signal the setting of the volume control can be judged by the loudness of the background noise. On "MVC," with the volume control set at maximum, very strong carrier waves will block the receiver and intelligible signals cannot be received.*
- (3) Set the receiver switch to "AVC." The desired signal should still be heard.
- (4) With the beat frequency adjustment at zero beat position (arrow on knob pointing up), turn the c-w oscillator switch to the position "ON." An audible beatnote should be heard which should vary in pitch when the beat frequency adjustment is changed.
- (5) With the c-w oscillator still "ON," throw the crystal filter switch to "IN." Noise should be greatly reduced and the signal can be tuned out by a much smaller movement of the tuning control knob than when the crystal filter switch is in the "OUT" position.
- (6) Turn the dial light rheostat and observe if control of illumination is secured with both dial lights functioning.
- (7) A check should be made before flight and with the airplane engine running. An increase of background noise when the engine starts, indicates imperfect shielding, imperfect bonding, faulty generator regulator, faulty generator, open filter capacitors, or a combination of these faults.
- (8) Always turn the receiver switch to the "OFF" position when the receiver is not being used.

### c Operating Routine

#### (1) Controls

##### (a) Antenna and Ground Binding Posts

The antenna is connected to the binding post marked "A," and the ground lead to the binding post marked "G."

##### (b) Antenna Alignment Control

This control varies a capacitor for aligning the input circuit to a given antenna. This adjustment should be made with the receiver tuned to approximately 500 kilocycles.

##### (c) Tuning Control

This control varies the setting of the 4-gang variable tuning capacitor.

##### (d) Band Switch Control

This control selects the desired frequency band as indicated on the dial mask.

##### (e) Dial Lights Control

This knob controls the intensity of dial illumination and is provided with an off position.

##### (f) C-W Oscillator Switch

This toggle switch controls the operation of the c-w oscillator as well as the a-v-c time constant for c-w reception.

##### (g) Crystal Filter Switch

This control permits the insertion of an i-f crystal filter when extreme selectivity is desired.

##### (h) Beat Frequency Control

This control permits vernier adjustment of the c-w oscillator frequency and in tuning it should be set near the zero beat position (arrow on knob pointing up).

##### (i) Volume Control

This control is for sensitivity adjustment on "MVC" operation and output level adjustment on "AVC" operation. When switching from "MVC" to "AVC" or vice versa, it will generally be necessary to readjust this control to maintain a given volume level, as only under certain conditions of signal strength will the volume level remain unchanged.

##### (j) "AVC-OFF-MVC" Switch

This three-position switch in the "OFF" position removes all power from the receiver. In the "MVC" position the receiver is operative with manual volume control, while in the "AVC" position the automatic volume control is functioning.

*(k) Telephone Jacks*

These are open circuit jacks providing connections to the headset.

*(2) Modulated Signal Reception*

- (a)* Throw the "AVC-OFF-MVC" switch to "MVC" and set other switches and controls as follows:

"C-W OSC"—"OFF"

"CRYSTAL"—"OUT"

Antenna alignment set as in Par. 13.

- (b)* Set the band switch to the desired frequency band and adjust the tuning control to the desired frequency. It is of great importance that this tuning be accomplished with the receiver switch in the "MVC" position.

*NOTE: The "AVC" position should not be employed while tuning in a signal. Tuning should always be done in the "MVC" position and with the volume control advanced only as far as required for a comfortable output level.*

- (c)* Increase the volume control until the desired signal is heard or the background noise attains a fair level.
- (d)* Adjust the tuning control until maximum output from the desired signal is obtained. This insures correct alignment or proper tuning of the receiver.
- (e)* If automatic volume control is desired,

switch to the "AVC" position and readjust the volume control for the desired output level.

*(3) C-W Reception*

- (a)* The procedure is the same as outlined above with the exception that the c-w oscillator switch is "ON" and tuning accomplished with the beat frequency control set near the zero beat position (arrow on knob pointing up).
- (b)* After tuning in the desired signal the beat frequency control may be varied and the frequency of the beat note adjusted as desired.
- (c)* Automatic volume control may be employed for c-w reception by switching to the "AVC" position and readjusting the volume control.
- (d)* When extreme selectivity is desired to minimize interference, the crystal filter is switched "IN." A slight readjustment of the tuning, beat frequency and volume controls may be required to secure the desired beatnote frequency and volume level.

*NOTE: The crystal band pass filter is intended primarily for use in c-w reception. However, the added selectivity may at times prove helpful in receiving modulated signals through heavy interference.*



## SECTION III

### DETAILED FUNCTIONING OF PARTS

#### 15 CIRCUITS

Electrically the receiver comprises two stages of tuned radio frequency amplification preceding the first detector, a temperature compensated heterodyne oscillator, three intermediate frequency amplifier stages, a second detector and one stage of audio-frequency amplification with a transformer output circuit. A crystal band-pass filter and beat-frequency oscillator are also included. The former is for increasing selectivity and the latter for receiving C-W signals. The schematic and wiring diagrams are shown in Section V.

#### 16 FREQUENCY RANGE AND FREQUENCY BANDS

The frequency ranges of 200 to 500 kilocycles and 1.5 to 18.0 megacycles are covered in six bands which are under the control of a band change switch. The frequency range for each of the six bands is given in the following table:

Band	Frequency Range
1	200- 500 KC
2	1.5- 3.5 MC
3	3.5- 6.0 MC
4	6.0- 9.5 MC
5	9.5-13.5 MC
6	13.5-18.0 MC

#### 17 INPUT COUPLING

The antenna input circuit is capacitively coupled to the first tuned grid circuit by means of the antenna alignment capacitor. Sufficient range is available in this capacitor to permit alignment for antenna capacities within the limits of 50 to 200 micromicrofarads. The antenna input circuit is designed for antennas whose resistance is between 1 and 5 ohms.

#### 18 INPUT PROTECTION

The resistor 65-1 provides a leakage path for static charges which may be collected on the antenna. The input circuit will withstand the application of 250 volts d-c without damage. For protection against the application of radio frequency voltages up to 30 volts R.M.S., the input circuit

provides for the overshooting of the grid of the first r-f tube and the building up of a protective negative grid bias across the grid filter resistor.

#### 19 RADIO FREQUENCY AMPLIFIER

The radio frequency preselector comprises three tuned circuits coupled by two Tubes VT-86 (super control pentode amplifier tubes). Separate inductances are employed for each frequency band. The r-f gain of each of the six bands is kept uniform by selection of the turn ratio between the grid and plate circuit for each of the respective bands. A relatively low signal level is maintained at the grid of the first detector tube, thus insuring freedom from cross modulation interference.

#### 20 FIRST DETECTOR

The first detector employs a Tube VT-91 which has a sharp cutoff characteristic. The low signal level at the grid of the first detector, together with the r-f preselection, insures a minimum of undesired responses. The oscillator output is coupled into the cathode circuit of this tube, and separate cathode coupling coils provide optimum oscillator output for each frequency band.

#### 21 HETERODYNE OSCILLATOR

The heterodyne oscillator employs a tuned grid, plate feedback circuit, utilizing a triode Tube VT-65. The effects of wide variations in ambient temperature under service conditions on the oscillator frequency have been reduced to a minimum by the use of a highly stabilized tuning capacitor and temperature compensation with ceramic fixed capacitors (40, 41, 42, 43, 44, 45 and 46). Individual inductances and trimmers are employed for each frequency band, and the low impedance coupling circuit to the cathode of the first detector insures a freedom from frequency instability with load variations or detector circuit tuning. On the four lower frequency tuning bands the oscillator frequency is higher than the desired signal by the intermediate frequency. On the two higher frequency ranges, Bands 5 and 6, the oscillator is on the low frequency side of the desired signal. The latter results in a more uniform tuning ratio over these bands and increases the image rejection ratio.

**22 INTERMEDIATE FREQUENCY AMPLIFIER**

The intermediate frequency amplifier comprises three low gain amplifying stages coupled by four highly selective, double-tuned circuit transformers. The intermediate frequency employed is 915 kilocycles. The i-f transformers are tuned by means of adjustable iron cores and fixed capacitors. The increased permeability resulting from the use of the iron cores contributes largely to the highly selective transformer characteristics, while the lowered tuned circuit impedance, secured by the relatively large fixed tuning capacitors, provides, an inherently stable amplifier. A Tube VT-86 functions as the first i-f amplifier while the pentode section of a Tube VT-70 is employed as the second i-f amplifier. A Tube VT-93, as the third i-f amplifier, supplies a relatively high level signal to the diodes of this same tube.

**23 C-W OSCILLATOR**

a The c-w oscillator employs the triode section of the Tube VT-70 (second i-f amplifier tube) in a tuned grid plate feedback circuit. The adjustable iron core in the grid inductance 121 is employed

for rough frequency alignment, while a small panel-operated beat frequency control permits fine adjustment of the beat frequency within a range of approximately 4,000 cycles each side of zero. The effects of ambient temperature variations are minimized by the use of a temperature compensated tuned circuit. The c-w oscillator operates at an extremely low level, minimizing harmonics and stray oscillator pickup. The output is capacitively coupled to the plate circuit of the second amplifier tube by the coupling lead connected to the oscillator grid. Amplification by the third i-f amplifier stage, the gain of which is not controlled either by manual or a-v-c, provides sufficient output from the c-w oscillator to the diode detector. This value of oscillator output is somewhat below the level at which the a-v-c operates, thus permitting the use of automatic volume control even for c-w reception.

b The c-w oscillator switch 128 in the "ON" position supplies the oscillator plate voltage and increases the a-v-c time constant by connecting the additional capacitor 123-c. Switch 128 supplies the oscillator plate voltage by connection to the screen grids of the first and second i-f and first

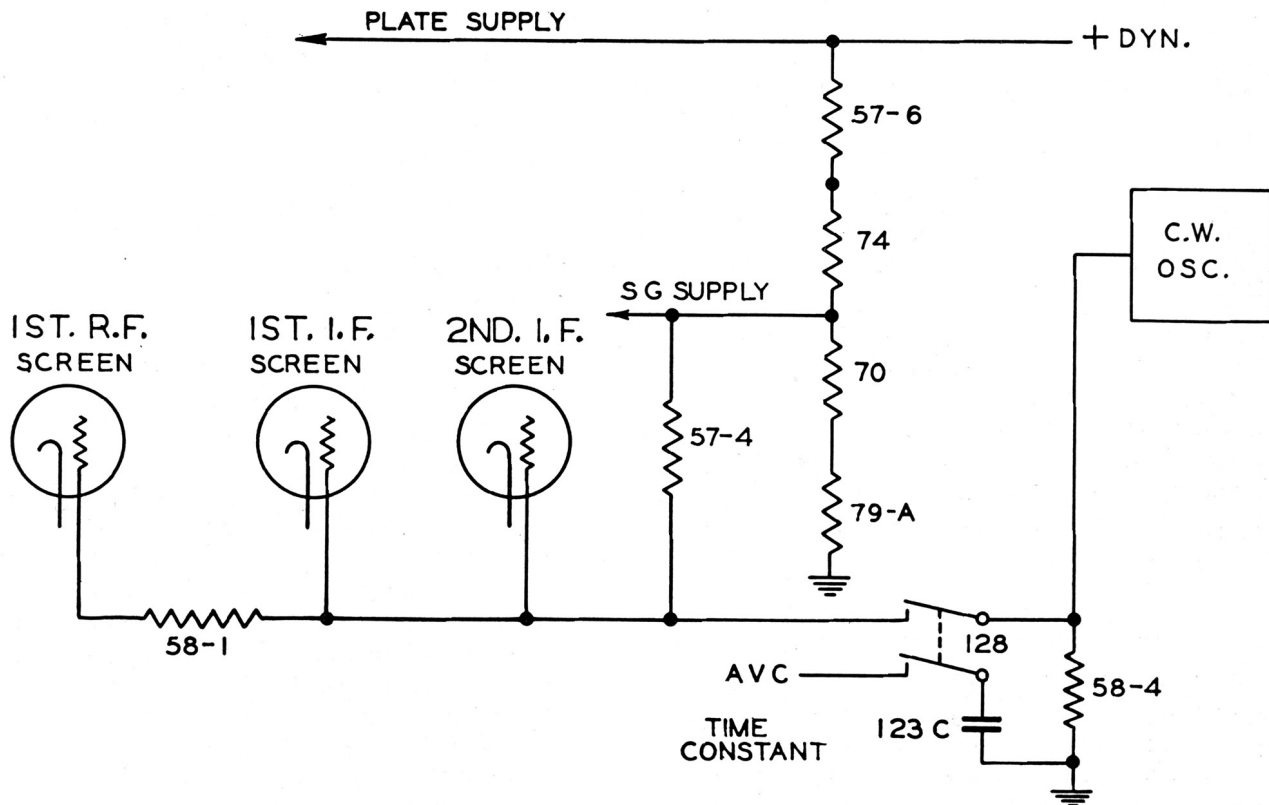

FIGURE 9—C-W OSCILLATOR SWITCHING

## Pars. 23-26

r-f tubes. The same switching connects the loading resistor 58-4 which drops the screen voltage to the first and second i-f and first r-f tubes to a value that reduces the sensitivity by an amount sufficient to keep the overall set noise essentially constant. This arrangement for supplying the c-w oscillator has added advantages which are not obvious. In order to have sufficient oscillator excitation available to handle high detector levels encountered with a-v-c delay operation and strong signal inputs, while still keeping the no-signal c-w excitation below the a-v-c level, it is desirable to have the c-w oscillator output increase as a strong signal input raises the a-v-c bias. This circuit arrangement, as shown in FIGURE 9, accomplishes this result, since with switch 129 in the a-v-c position, resistors 57-6, 75, and 79-A form a fixed bleeder supplying the screen grid voltage to r-f, 1st detector and i-f tubes. A strong

tapped tuned circuit (118 and 34-1) matches the impedance of the crystal bridge to the first i-f grid. The crystal filter may be switched in or out of the circuit by the "CRYSTAL OUT-IN" switch 127, actuated from the front panel. The symmetry of the resonance curve is adjustable by the balancing capacitor 8. The filter band width is adjustable by the secondary core of the first i-f transformer 117. As delivered by the manufacturer the band width is set at approximately 2,000 cycles. For adjustment see paragraph 35c (10).

## 25 SECOND DETECTOR

The Tube VT-93 also functions as the second detector. A relatively high level signal is supplied by the third i-f amplifier to the diodes of this tube. One diode functions as the signal linear detector while the other diode is capacity coupled and provides high level, delayed a-v-c control bias.

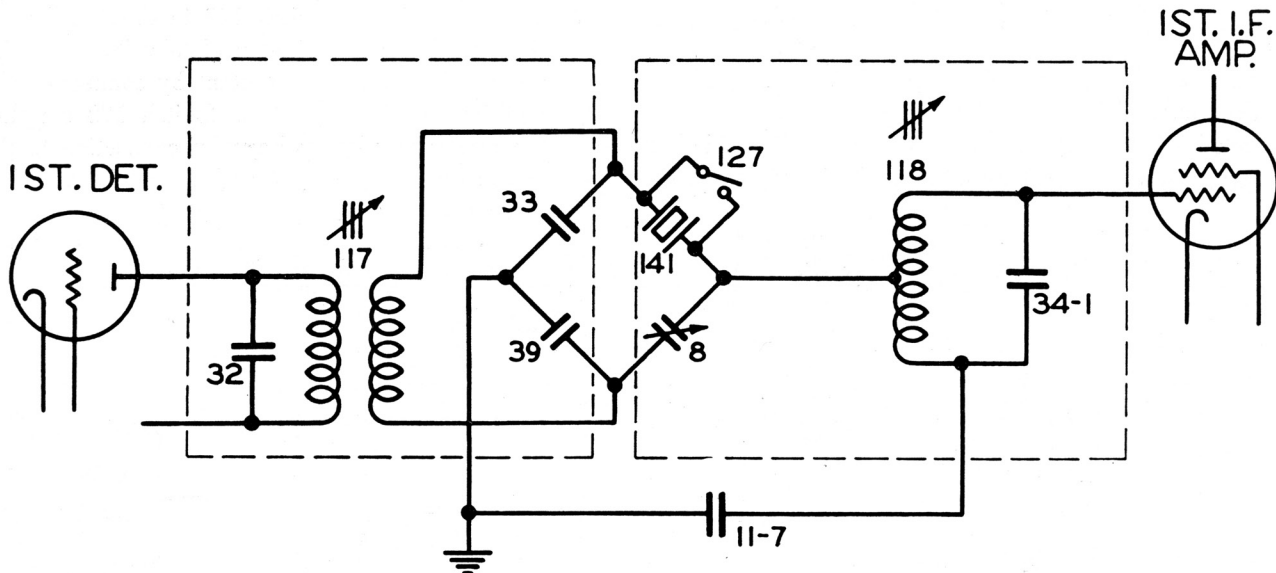

FIGURE 10—DETAILS OF CRYSTAL FILTER CIRCUIT

input signal building up the a-v-c bias causes a considerable decrease in screen current and hence an increase in the screen supply voltage. This increases the voltage supplied to the c-w oscillator, and hence the excitation increases in proportion to signal level at the detector.

## 24 CRYSTAL BAND-PASS FILTER

Additional selectivity is available by the use of the i-f crystal filter preceding the first i-f amplifier tube. This crystal filter comprises a balanced capacity bridge circuit which may be adjusted internally to provide a band width of 800 to 3,000 cycles at 10X down from resonance. The

## 26 OUTPUT

### a Description

The high level signal diode supplies audio output for driving the VT-152 output tube without additional audio amplification. The design choice of three i-f amplifier stages and high level detection results in a number of operating advantages. The high level detection is relatively free from distortion, due to avoiding the characteristic curvature at the lower end of the diode curve. The direct drive of the output tube from the diode detector simplifies the dynamotor ripple filtering and eliminates possible microphonics resulting

from high audio amplification. The high diode level further provides relatively high bias voltage, insuring an unusually flat automatic volume control characteristic with the desired time delay. The dual volume control comprises potentiometers 79-A and 79-B. The latter, 79-B, functions only with the switch 129 in the a-v-c position, and in this condition it permits the desired adjustment of the audio level to the output tube and load. For manual volume control with switch 129 in the m-v-c position, the potentiometer 79-A becomes the active control operating on the cathode bias of the r-f and the 1st and 2nd i-f amplifier tubes. These potentiometers have two linear resistance tapers providing a smooth variation of sensitivity. Automatic load compensation is obtained by the method of biasing the output tube. Here, the grid bias is obtained from the resistance drop across

noise when tuning from the low to the high frequency end of a band has been corrected in this design by means of the variable resistor 78. The function of this potentiometer can be more clearly understood by reference to Figure 11. Here the noise compensator 78 is mechanically connected to the shaft of the ganged tuning capacitor with the electrical connection such as to give minimum resistance at the low frequency end of the band. The cathode return lead of the second r-f amplifier tube connects to the noise compensator 78, and hence the gain of this stage is decreased proportionally as the r-f tuned circuit impedance increases when tuning toward the higher frequency end of the frequency band. This arrangement tends to maintain the noise level and receiver sensitivity essentially constant over the tuning ranges.

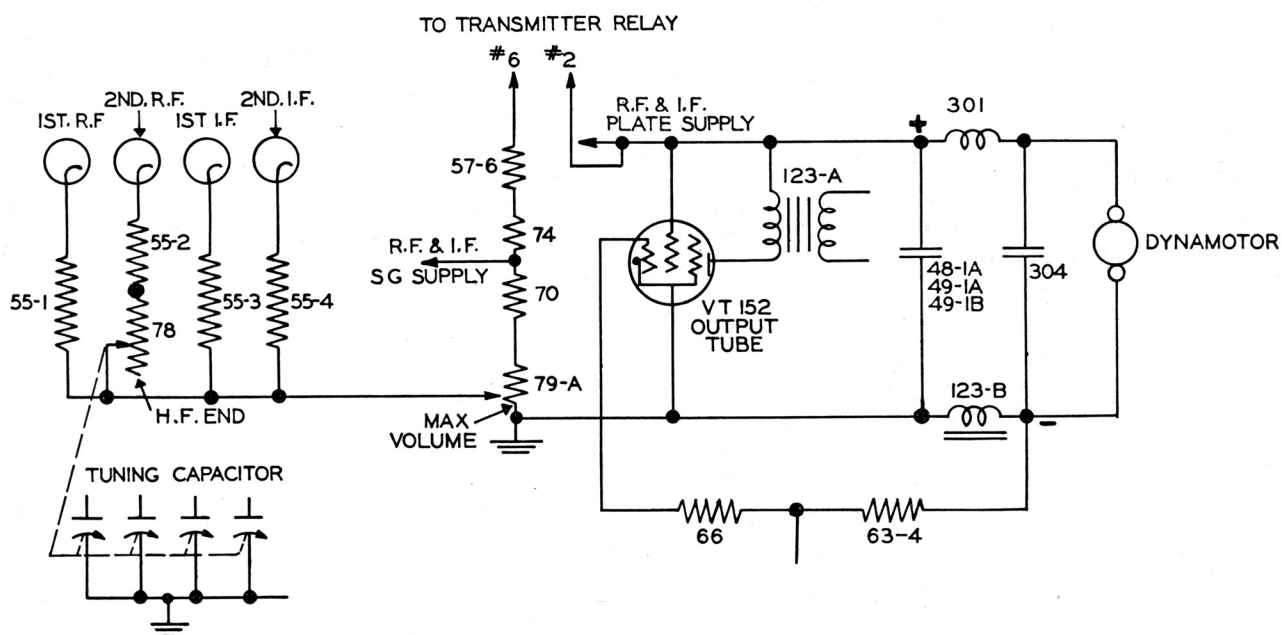

FIGURE 11—LOAD COMPENSATOR AND BLEEDER CIRCUIT DIAGRAM

the dynamotor filter reactor; thus, any tendency towards a decreasing load on the dynamotor results in a slight decrease in the bias of the output tube with a compensating increase in the load current. (See Figure 11.) The tube VT-152 provides a considerable margin of power capability above that necessary to operate a number of headsets in parallel.

*b Constant Internal Receiver Noise*

The characteristic increase of internal receiver

**27 DYNAMOTOR DM-28-H**

The dynamotor and associated r-f filter circuits are assembled in one unit. The r-f filters are of the unbalanced type for use with a primary supply in which the negative side is grounded. This dynamotor supplies all of the high voltage direct current required for the operation of the receiver and, in addition, a maximum of 20 milliamperes for use in operating accessory equipment.

**Par. 28**

**28 CHARACTERISTICS OF TUBES, LAMPS, VOLTAGE REGULATOR AND FUSE**

**Tube Characteristics**

Tube	Heater		Screen Volts	Plate Volts	Grid Volts	Plate Ma	Screen Ma	Mu	Plate Resistance Ohms	Transcon- ductance Micromhos
	Volts	Amps.								
VT-86	6.3	0.3	100	250	-3	7.0	1.7	1,160	800,000	1,450
VT-91	6.3	0.3	100	250	-3	2.0	0.5	1,500	1,500,000	1,225
VT-70	6.3	0.3	100	250	-3	6.5	1.5	900	850,000	1,100
		Tri.	...	100	-3	3.5	..	8	16,000	500
VT-93	6.3	0.3	125	250	-3	10.	2.3	800	600,000	1,325
VT-65	6.3	0.3	...	250	-8	8.	..	20	10,000	2,000
VT-152	6.3	0.4	250	250	-18	32.	5.5	150	68,000	2,200

**Dial Lamps**

Type	Volts	Amps.
LM-27	6.3	0.25

**Voltage Regulator**

Type 991—Starting Supply Voltage	87 volts min.
Operating Voltage	60 volts
Operating Current	0.5 to 2 milliamperes

**Fuse**

Type	Amps.
FU-35	5

## SECTION IV MAINTENANCE

*NOTE: No attempt at either mechanical or electrical servicing of this receiver should be made except at signal corps repair shops and signal corps radio section (or signal sections) at air depots unless suitable shop and testing facilities are available and authority to repair has been granted by the corps area signal officer. A standard signal generator, a phantom antenna, a test set I-56-A, and other like equipment should be used for alignment purposes and the instructions in this book carefully followed.*

### 29 INSPECTION

- a Daily*—Turn on receiver. Check dial lamps. Check for operation on all bands with c-w oscillator “on.” This test can best be made by observing noise level with volume control at maximum.
- b 20 Hours*—Repeat above with additional check of antenna, ground and cable connections for effects of vibration.
- c 40 Hours*—Repeat above with additional check of all vacuum tubes, regulator tube and dial lamps. Inspect receiver for loose grid clips, tube shield, etc. Inspect all tubes with Model 685 Type 2, Tube Checker of Test Set I-56-A.
- d 6 Months*—Repeat above with additional cleaning and lubrication of dynamotor as described in paragraph 30.
- e 1 Year*—Repeat above with inspection and replacement of dynamotor brushes, if necessary. Lubricate dial and tuning condenser drive mechanism. Check dynamotor and tube socket voltages as described in paragraphs 35c (1) and 35c (3).

### 30 CARE AND SERVICING OF DYNAMOTOR DM-28-H

- a* The dynamotor and filter assembly is removable from the receiver chassis without disturbing other parts, provided the procedure outlined below is followed:

Loosen the two thumb screws on the receiver panel, and draw the chassis from the cabinet. Lay the chassis with top upwards on a smooth, flat surface with the rear toward the operator. Loosen the five connector screws on the dynamotor terminal strip and withdraw the spade terminals from beneath them.

Loosen the four captive screws 211, Figure 12, which hold the dynamotor unit to the chassis. Remove the dynamotor and filter assembly from the receiver by grasping the dynamotor and lifting vertically.

The filter portion of the dynamotor unit is made accessible by the removal of the cover at the bottom. See FIGURE 12.

This dynamotor requires lubricating after 1,000 hours or approximately 6 months of ordinary service and should be lubricated with none other than Air Corps Grade 375 grease. The directions for lubrication are stamped on the inside of the end-bell dust covers. Access to the bearings of the dynamotor is obtained by first removing the dust covers after cutting the safety wires and removing the retaining screws, then unscrewing the bearing end plates. Do not PACK the lubricant in these bearings.

- b* When necessary to replace the ball bearings or turn down the commutators, first remove the brushes from their cartridges. Remove the nuts from the tie rods which hold the bearing end-bells and pull the end-bells away from the field coil assembly. The armature can now be taken out. Examine the brushes to see that they have worn properly and are free from hard spots. Should such spots be apparent (they generally cause grooves in the commutator surface), the brush should be replaced and the commutator smoothed down. The ball bearing retainers and the shaft are machined for very snug fits, but a slight tapping will loosen them. To remove the bearing retainers from the end-bells use two small screwdrivers as wedges between the outer ball race and the end-bell. If the grease slinger becomes bent during removal, it should be straightened and replaced on the shaft before replacing the bearing.
- c* To smooth down the commutator rotate it in a lathe holding a fine grade of sandpaper, not coarser than size 00, lightly against the commutator surface. Do not use emery cloth. All residue of dust, sand and dirt, should be wiped away to leave a clean, smooth, polished commutator surface. A commutator having a smooth or polished surface should never be sanded or turned down simply because it is discolored. If the com-

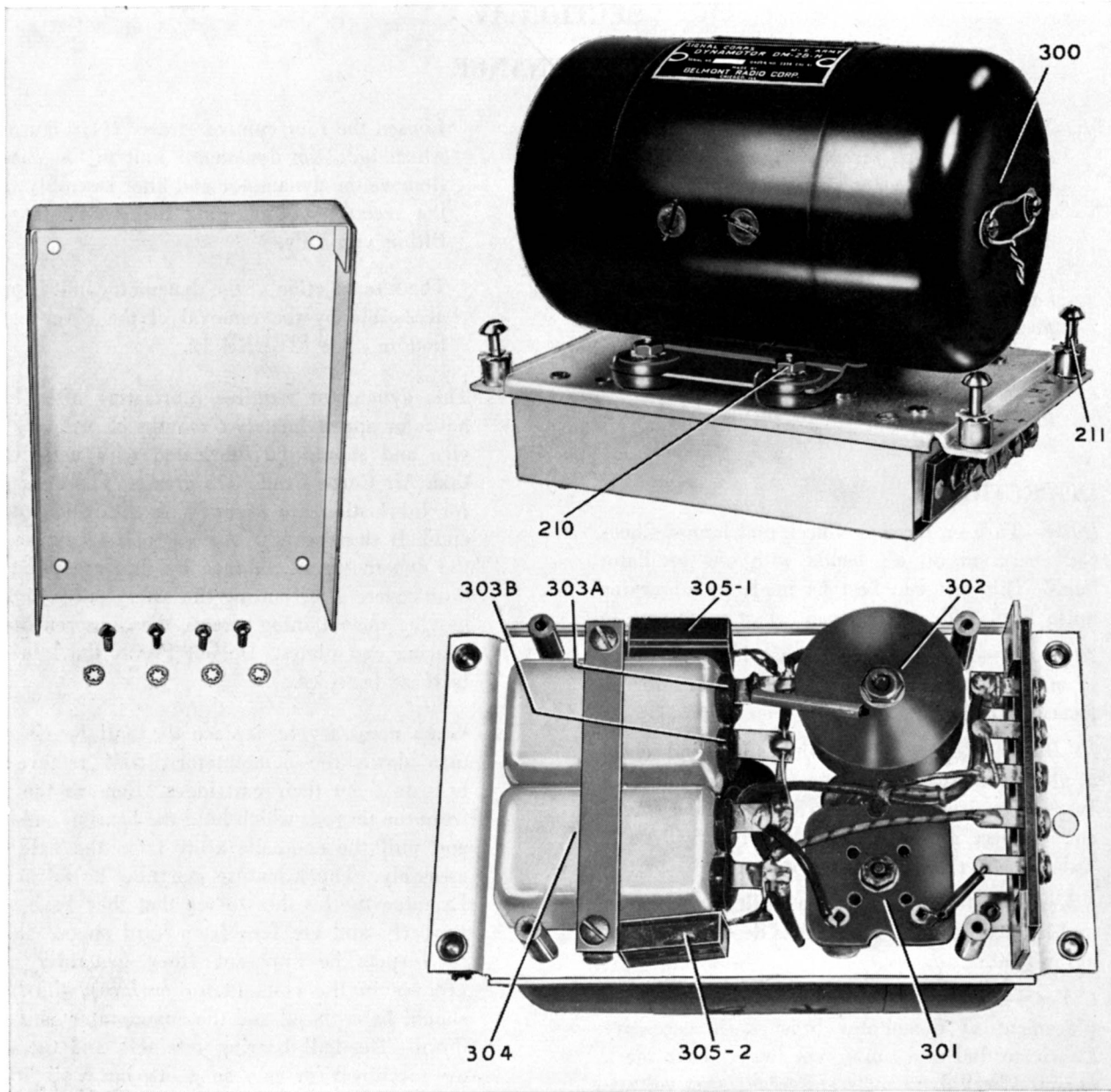

FIGURE 12—DYNAMOTOR DM-28-H AND VIEW SHOWING FILTER OPEN

mutator is turned down in a lathe, the mica segment separators must be undercut.

d Re-assembly of the dynamotor is accomplished in substantially the reverse of the disassembly procedure, except that the use of the screw-drivers as wedges is not necessary. In replacing the brushes check to see that the + and - markings on the brushes correspond with those on the brush holder supports, and that the marked side of the brush is towards the top of the dynamotor. The commutator must be given a final inspection for free

running, cleanliness and absence of grease or oil. The end-bells should be wiped clean and dry before replacing them on the dynamotor.

e The nominal rating of Dynamotor DM-28-H is: Input, 1.23 amperes at 27.9 volts; Output, 70 milliamperes at 220 volts; Regulation 12 per cent. Average performance data on Dynamotor DM-28-H is as follows: (dynamotor and filter disconnected from receiver and negative high voltage connection made to case of unit.)

DYNAMOTOR DM-28-H

Input		Output	
Volts	Amperes	Volts	Milliamperes
24	0.7	215	0.
24	1.1	210	30.
24	1.3	202	60.
28	0.8	258	0.
28	1.1	246	40.
28	1.5	236	75.

31 REMOVAL OF FRONT PANEL

a For adjustment of dial or mask, or for servicing of certain parts, it may become necessary to remove the panel. The chassis, with panel attached, should be taken completely out of the cabinet

and placed for inspection with the panel facing upwards. Unsolder the lead to the antenna binding post and the lead from the chassis to the dial lights. Remove the dial light housing cover, the two thumb screw rods, the handles, and all knobs

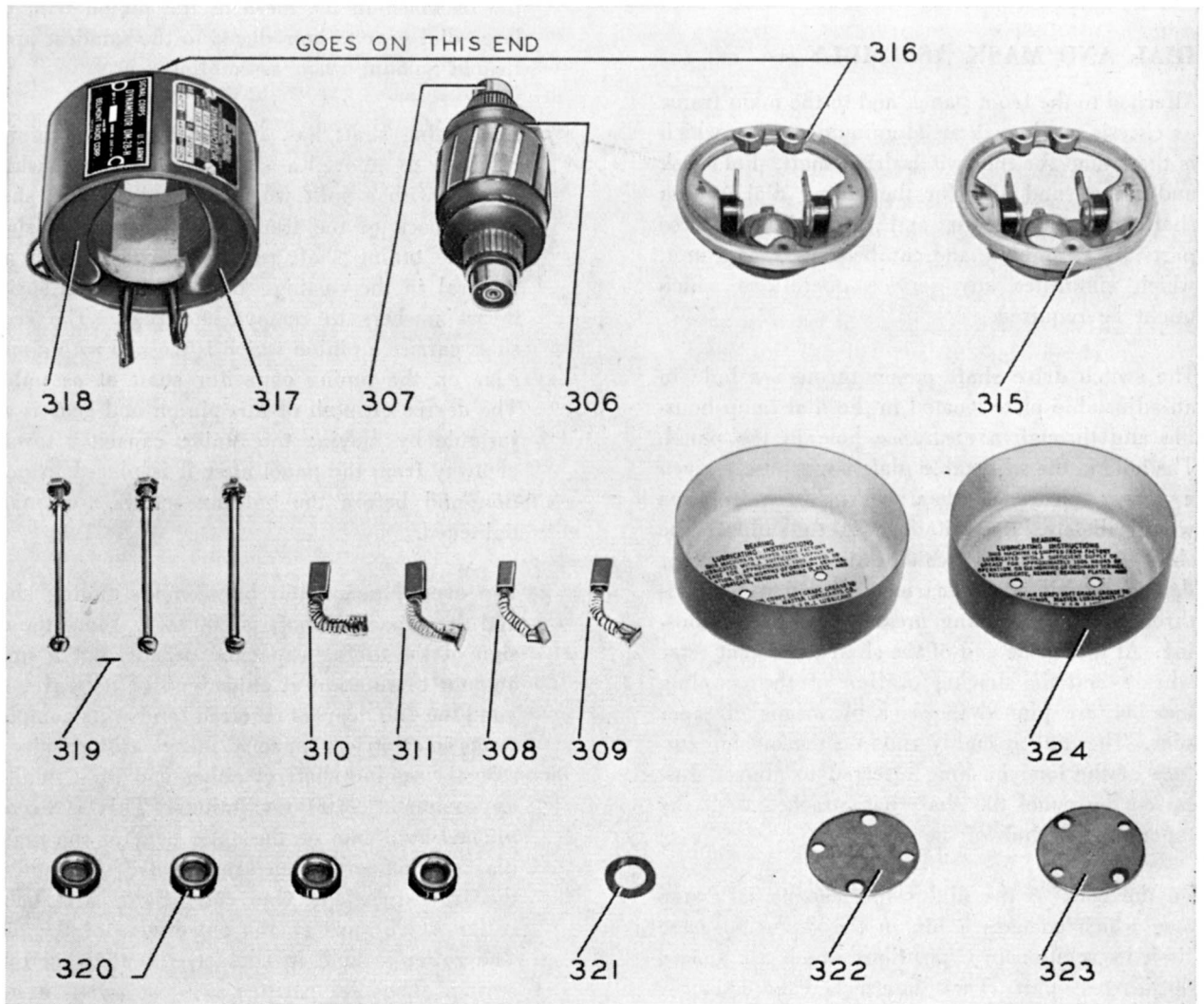

FIGURE 13—DYNAMOTOR DM-28-H, DISASSEMBLED



## Pars. 31-32

and retaining nuts of all controls except the "DIAL LIGHTS" control. The retaining nuts of the "TEL" jacks should also be removed. The panel may be lifted off after the removal of the end plate holding screws, the chassis holding screws, and the dial casting holding screws.

- b* In replacing the "BEAT FREQ." control knob, turn the flexible shaft until the set screw in the coupling at the internal end points away from the panel. Now mount the knob so that the arrow points vertically towards the top of the receiver. This knob has two set screws. In replacing the other knobs on the shafts, it will be noted that flats on the shafts provide for proper location. All set screws must be securely tightened, and the set screw on the band switch knob in particular should be given a second tightening after the shaft has been rotated a few times.

## 32 DIAL AND MASK ASSEMBLY

- a* Attached to the front panel, and to the main frame or chassis casting, is an aluminum casting which is the frame for the switch drive shaft, dial mask and detent, and also for the tuning dial, tuning shaft, reduction gears, and stop. All of these parts are assembled, and can be moved, as a unit, which simplifies any service operations which might be required.
- b* The switch drive shaft passes through a hole in an adjustable plate located in the dial lamp housing and through a clearance hole in the panel. The hole in the adjustable plate is purposely given a larger clearance than bearing requirements would dictate, since its use is to support the shaft against forces which might spring it or damage the internal bearing. The shaft extends through a long bushing pressed in the dial housing. At the inside end of the shaft the detent (star wheel) and the driving portion of the coupling member are pinned in place by means of taper pins. The dial assembly runs on the outside surface of the long bushing referred to above. Just inside the panel the shaft has attached to it, by taper pin, the hub of the mask.
- c* On the back of the dial frame casting is a stop arm which engages a pin in the detent so as to limit its rotation to 6 positions which are spaced 60 degrees apart. There is attached the assembly of pivot pins, arms with rollers, and spring which positions the detent. This assembly is locked with two dowel pins after the correct location is made.
- d* On the front (panel) end of the bushing through which the switch shaft passes there is a narrow shoulder which supports the lower end of the dial index plate. This index plate is attached to the casting at its upper end with means for removing any slack and keeping it straight and taut. The inner end of the mask hub and the outer end of the dial hub turn, and are held, against opposite sides of the index plate.
- e* The dial is attached to a flange on a hub which runs on the outside surface of the bushing through which the switch drive shaft passes. This hub also carries a large gear which is driven by a pinion combined with a split idler gear. This split idler gear and pinion has adjustment in the clearance holes for the mounting screws to enable the backlash in the mesh of the pinion with the large dial gear to be reduced to the smallest practicable amount when assembling.
- f* The tuning shaft has, in addition to the pinion referred to above, a stop, and a worm which meshes with a split worm gear on a cross shaft at the back of the frame. Both this cross shaft and the tuning shaft run in bearings which are integral in the casting. Both shafts have spring thrust washers to remove end play. The cross shaft carries a pinion which is meshed with a split gear on the tuning capacitor shaft at assembly. The degree of mesh of this pinion and gear is adjustable by moving the tuning capacitor toward or away from the panel after it is placed in position and before the holding screws are finally tightened.
- g* The overall gear ratio between the tuning shaft and the capacitor shaft is 200 to 1. Since the design of the tuning capacitor permits but a small amount of rotation at either end of its travel beyond the 180 degrees required to give its complete range in electrical capacity, means are provided to stop the tuning shaft at either end of a total of approximately 100 revolutions. This is accomplished by a cam on the outer edge of the tuning dial which operates an arm pivoted on a pin on the frame casting. One end of this arm has a roller which runs on the outer edge of the dial. The roller is held in contact with the dial by a spring. The dial periphery is cut away in such a manner that when the point corresponding to either end of the tuning capacitor travel is

reached, the roller, and therefore the end of the arm, can move toward the center of the dial, being forced in that direction by the spring. Thus the opposite end of the stop arm is moved so that the hook at the end of the arm engages the rotating stop on the tuning shaft, and the shaft is thereby prevented from further turning. When the direction of rotation of the tuning shaft is reversed, the roller and arm are pushed outward against the spring by the cam edge of the dial and the stop disengages.

- h* Since a definite relation must be set and maintained between the dial position and the angular position of the rotor of the tuning capacitor, adjustment is provided at the pinion on the cross shaft at the rear of the frame. (This is the shaft which also carries the worm gear.) This pinion is held in place by two set screws which bear in a groove on the shaft. By loosening these two set screws, either the dial or the tuning capacitor can be rotated while the other part remains fixed. The correct relation between these is that the tuning capacitor rotor plates are fully meshed with the stator plates (maximum capacity) when the dial is set with the isolated index mark at the low frequency end of the 13.5 to 18.0 m.c. band in line with the index.

### 33 REMOVAL AND REPLACEMENT OF DIAL MECHANISM

- a* In the event that the dial mechanism is to be removed from the chassis for any servicing operations, it is necessary first to remove the front panel in accordance with instructions given earlier in this book (par. 31). The frame of the mechanism is attached to the chassis by the bracket holding the fuse, and by two slotted hexagon head screws through the flange on the under side of the chassis. Note that one of these screws is beneath the removable shield which covers the terminal of the first i-f transformer. When these screws are removed, the complete unit can be removed. The center disc of the flexible coupling is loose and will drop out of engagement.
- b* To remove the index and dial, the taper pin holding the mask hub to the switch drive shaft must be removed. It is necessary to support the shaft when driving out this pin, so that excess stress will not be placed on the center bushing. After the removal of the mask and the index, the dial and its gear are free to slide off the bushing. In replacing these parts, the thrust washer behind the dial hub must be turned in the position to give maximum thrust, which is convex side outward.
- c* If the dial is removed and replaced, it is possible that in meshing the dial gear with the idler gear the stop relationship may not be correct, in which case it may be necessary to change a tooth at a time to correct. The stop relationship must be such that the roller arm hook and the tuning shaft stop arm engage fully at the end of the last revolution, but on the previous revolution the arm must not start to move until after the rotating arm has passed under the roller arm hook. This adjustment can only be made by trial and inspection, but it can be secured in one or two trials. Substitution of a different stop arm may also require re-adjustment, but in this case the adjustment should be made by lengthening or shortening the roller end of the arm. This is done by loosening the two nuts on the arm, after which the arm can be adjusted by the slotted holes provided.
- d* When the dial mechanism is replaced, the flexible coupling must be properly positioned so that the position of the mask corresponds to the switch position, since it is possible otherwise to get the band switches to an inoperative position. The correct relative positions are obtained when the mask is set to band 200-500 kc and the set screw locking the flat switch shaft to the large bevel gear hub is vertical.
- e* If any of the gear trains including split gears have been unmeshed in disassembly, the split gears must be reset to put tension on the loose section when they are again meshed. Normally, a displacement of one tooth between the two sections is sufficient. Trial will show whether this will remove the backlash.
- f* When the dial mechanism is re-assembled to the chassis, the relation between the dial and the tuning capacitor must be carefully adjusted in order to maintain the calibration and prevent over-running the capacitor (Refer to paragraph 32*h*). This is done by loosening the two set screws in the pinion on the cross shaft on the back of the dial assembly. Before putting the mechanism in place, this pinion can be moved along the shaft toward the worm gear so as to clear the capacitor split gear. This facilitates assembly, since the gears can be meshed after the dial mechanism is bolted in place, making it easier to get the tension on the split gear in the capacitor assembly.

### 34 REMOVAL OF ANTENNA, R-F, DETECTOR AND OSCILLATOR UNITS

In many cases servicing of these units will require only the removal of the top or bottom cover of a particular unit; however, any unit may be removed and replaced independently as follows:

- a Unsolder the lead to the main tuning capacitor at the capacitor by first removing the capacitor shield. Unsolder all other leads at the unit.
- b Disconnect the band switch drive shaft and withdraw same from the antenna unit end.
- c In case of antenna unit, disconnect the antenna alignment control shaft.
- d Remove screws holding unit to the tie strips at the bottom.
- e Remove screws holding the unit to the chassis.
- f Lift the unit from the receiver, taking care that it comes out freely.

When replacing a unit, reverse the above procedure; however, do not tighten the chassis holding screws tightly until the drive shaft has been replaced and the band change switch knob has been rotated a number of times. This will insure the self-alignment of the unit and the proper action of the detent.

### 35 TROUBLE LOCATION AND REMEDY

#### a General

The normal sensitivity (number of microvolts input to produce 10 milliwatts output into a 4,000 ohm resistance load) of the receiver is better than 9 microvolts when measured under the following conditions:

“AVC-OFF-MVC” switch at “MVC”; 28 volts input; c-w oscillator “ON”; crystal filter “OUT”; output load 4,000 ohms non-inductive resistance; pure c-w input from signal generator applied between antenna-ground terminals through a 100-mmf dummy antenna; volume control set to produce 0.3 milliwatt noise output.

This sensitivity will, of course, be subject to variation with time due to tube aging, etc. *Therefore, it is recommended that no attempt be made to retrim or realign the equipment unless the sensitivity is found to be worse than 17 microvolts with new average tubes.* This receiving equipment has been carefully adjusted and aligned by the manufacturer before shipment and should maintain these adjustments over reasonably long periods of time. Major adjustments and repairs should be made only in an authorized repair shop equipped with the necessary servicing tools and equipment.

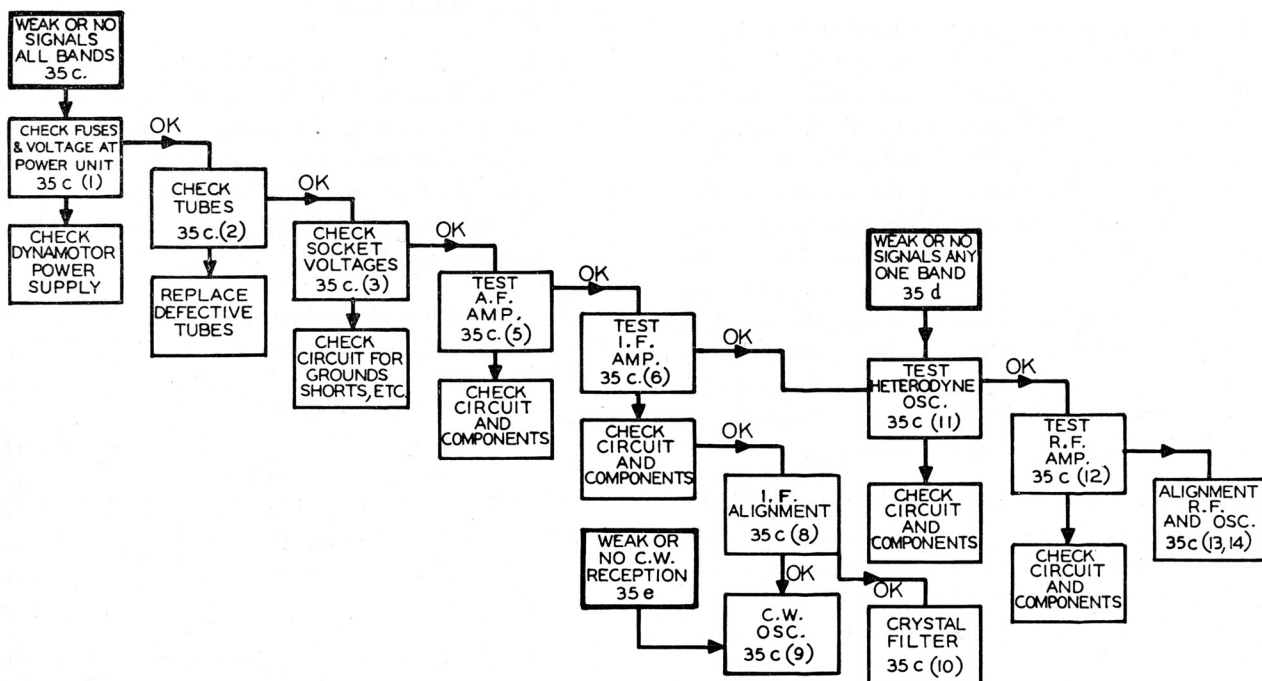

FIGURE 14—TROUBLE LOCATION AND CORRECTION CHART

All others must refrain from changing any of the adjustments of the radio frequency circuits. The difficulties usually experienced are the result of external deteriorating influences, such as wornout vacuum tubes, improper operating voltage, blown fuse, external noises, etc. However, in order to permit the servicing of this equipment, the testing procedure shown should be followed in determining the sources of trouble. This has been divided into the following major divisions, with respect to the nature of the troubles being experienced:

Equipment required—See paragraph 35b.

Weak or No signals on all bands—Modulated reception—See paragraph 35c.

Weak or No signals on any one band—Modulated reception—See paragraph 35d.

Weak or No Signals on all bands—C-W reception (modulated reception normal)—See paragraph 35e.

FIGURE 14, graphically outlines the procedure for trouble location, the numbers in each block referring to the paragraph numbering in the following discussion:

*b Equipment Required*

Few instruments other than those found in a

standard set analyzer (Test Set I-56-A) are required in locating the most probable troubles in this receiver. The individual instruments are as follows:

- (1) A modulated test oscillator (standard signal generator) with a frequency range from 150 to 18,000 k.c. with provision for calibration accuracy better than 0.1% at aligning frequencies.
- (2)\* Voltmeter—1,000 ohms per volt, ranges 0-10; 0-100; 0-250 volts.
- (3)\* Continuity tester.
- (4)\* Output meter rectifier type, 0-15 volt, 4,000 ohms.
- (5) Microammeter, 0-200.
- (6) Audio frequency oscillator.
- (7) Pair of telephone receivers.
- (8) An Adapter, FT-211 consisting of an 8-prong octal plug, and an 8-prong octal socket connected together by a short length of 8-conductor cable, to permit use of the Test Set I-56-A Analyzer on the r-f tubes on the tube shelf.

\*Part of Test Set I-56-A.

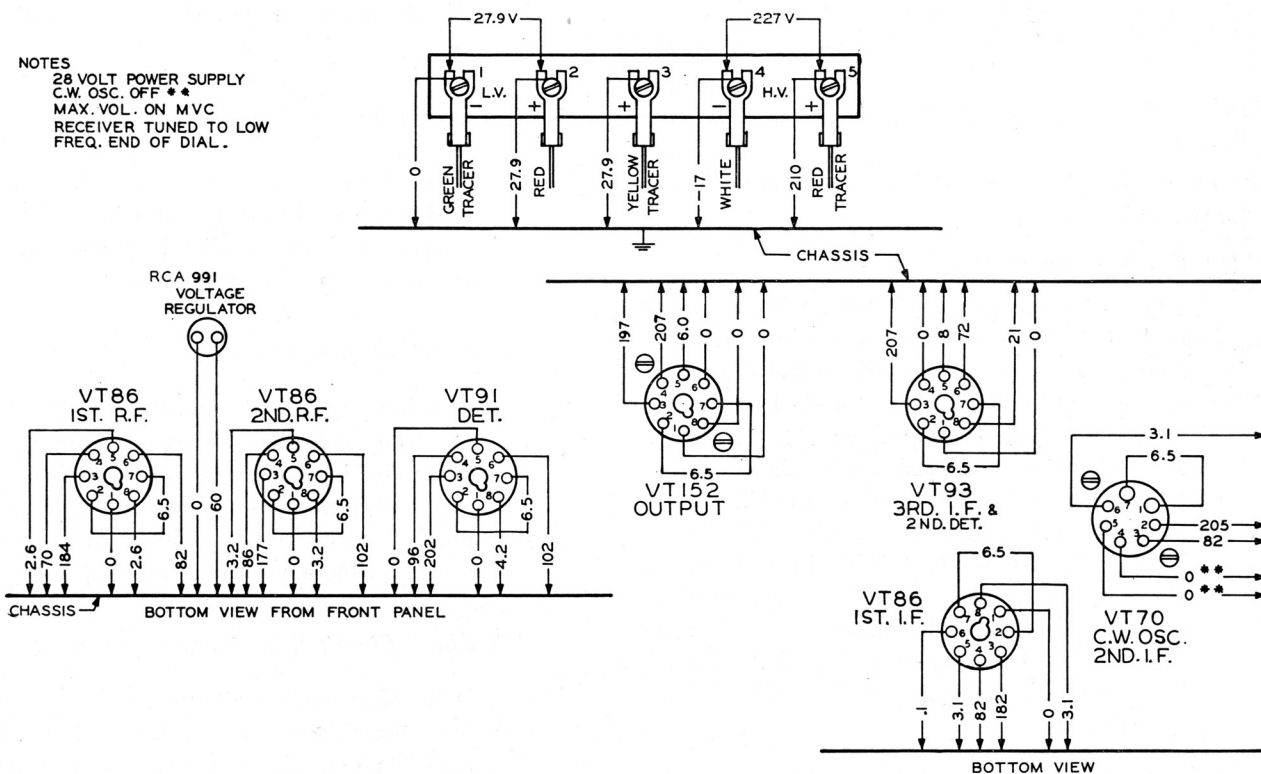

FIGURE 15—RADIO RECEIVER BC-348-H: DYNAMOTOR AND TUBE SOCKET VOLTAGES

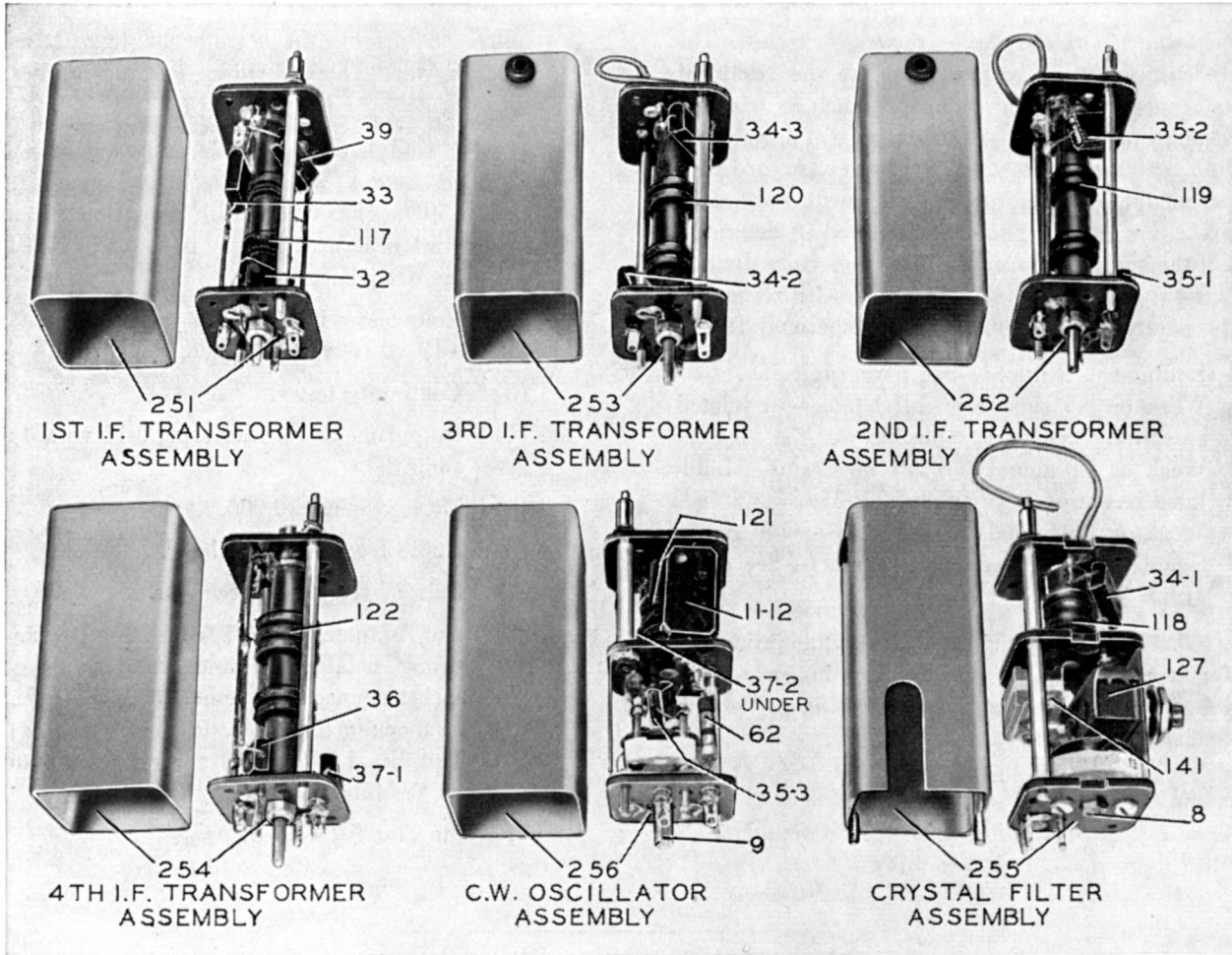

FIGURE 16—I-F TRANSFORMERS, C-W OSCILLATOR AND CRYSTAL FILTER ASSEMBLIES

*c Weak or No Signals on All Bands, Modulated Reception*

(1) *Check of Dynamotor Voltages*

When all signals on all bands are weak or no signals are heard even when known to be present, the procedure follows that shown in the chart. The voltages checked at the dynamotor terminal board should closely approximate the values shown in Figure 15. Conditions for measurement are as follows: Input 28 volts; Crystal "Out"; "MVC"; Volume Max; C-W Osc. "Off"; Load 4,000 ohms resistance. If these voltage readings do not approximate the values shown, the fuse should be checked as well as the dynamotor and filter circuits, wiring and components.

(2) *Tube Check*

If the voltages at the dynamotor terminal

board approximate the values given, proceed to check all tubes for emission and characteristics or replace all tubes with those of known average characteristics.

(3) *Check of Socket Voltages*

If tubes check satisfactorily, or if, after replacing with tubes known to be good, the sensitivity is still low, proceed to check all tube socket voltages as outlined under paragraph 35f with Test Set I-56-A. The average socket voltages are given in Figure 15.

(4) *Check Circuit Wiring and Components*

If the tube socket voltages do not approximate the values shown in FIGURE 15, the associated circuits and components should be checked for grounds, shorts, and similar defects.

(5) *Test of Audio-Frequency Amplifier*

Having checked all socket voltages and found the values to be correct, proceed to the test of the audio frequency amplifier. This can be checked by capacitively-coupling a 400-cycle voltage of approximately 2 volts R.M.S. from the detector diode socket

output for 915 kc. input. Circuits, wiring and components should be checked if this order of response is not obtained.

(6) *Test of Intermediate-Frequency Amplifier*

Following a satisfactory test of the audio amplifier, check the intermediate frequency amplifier by capacitively coupling the mod-

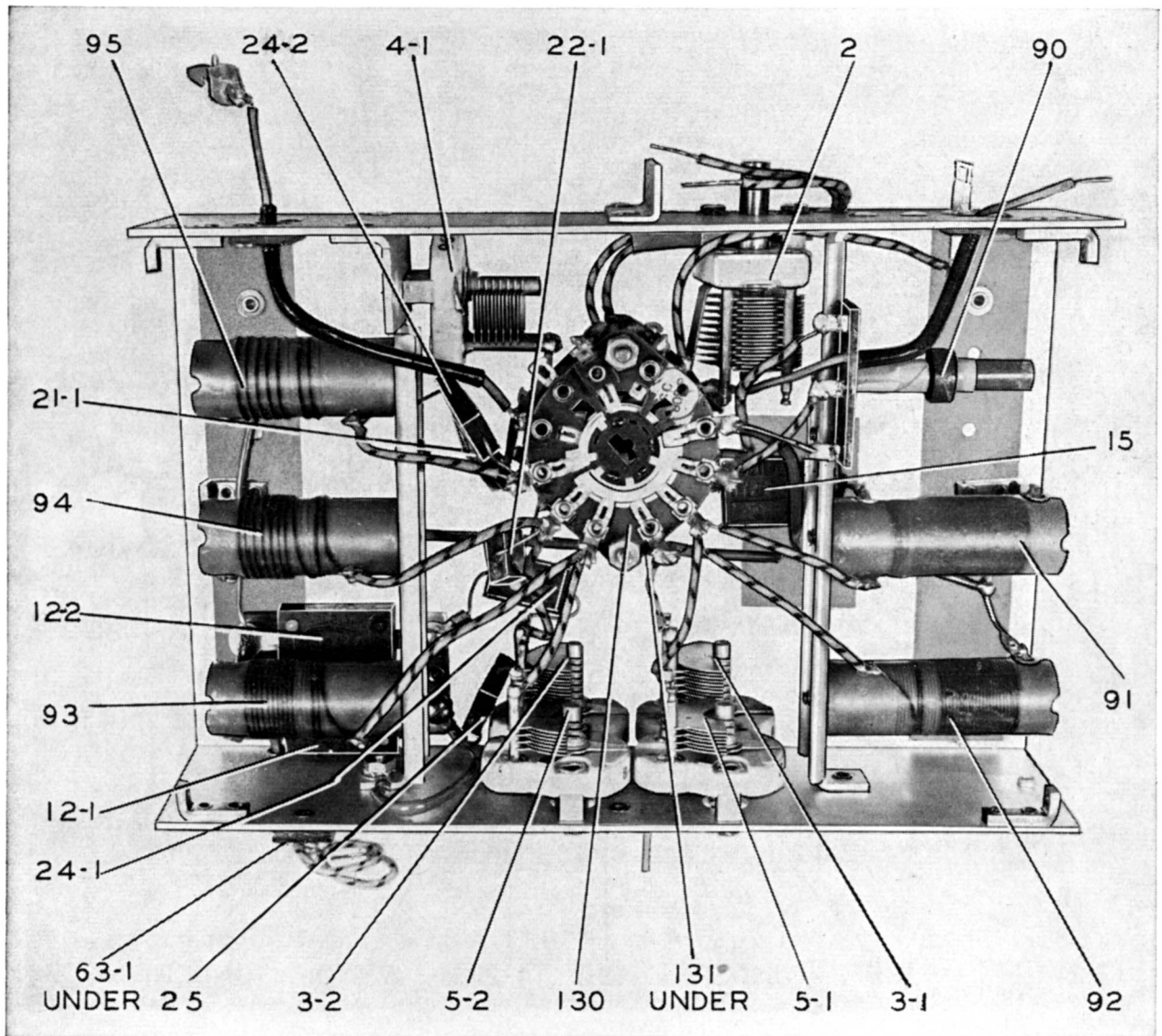

FIGURE 17—ANTENNA UNIT

prong to ground using a capacitor of 0.5 mfd. As an alternative, a modulated 915 kc. signal of 2 volts may be coupled to this point and ground. Proper functioning of the audio amplifier will be indicated by an output well over 10 milliwatts for the 2 V. audio input or approximately 1 milliwatt

ulated test oscillator to the grid cap of the first detector tube and ground, through a 0.1 mfd. capacitor, the frequency being adjusted to 915 kc. A rough check of the proper functioning of the i-f amplifier is indicated by a comfortable headphone output level with low input from the test oscilla-

Par. 35

tor. (Approximately 30 microvolts input for 10 milliwatts output.)

(7) *I-F Amplifier Circuit Check*

If the i-f amplifier does not respond as above or lacks sensitivity, a progressive check, stage by stage, should be made. The test oscillator, 915 kc. modulated input, is

each stage should show a decided gain, and a faulty stage can be circuit checked for grounds, shorts, or defective components.

(8) *Alignment of I-F Amplifier*

When all stages have been tested, the i-f amplifier alignment is checked by capacitively coupling a low level input signal of

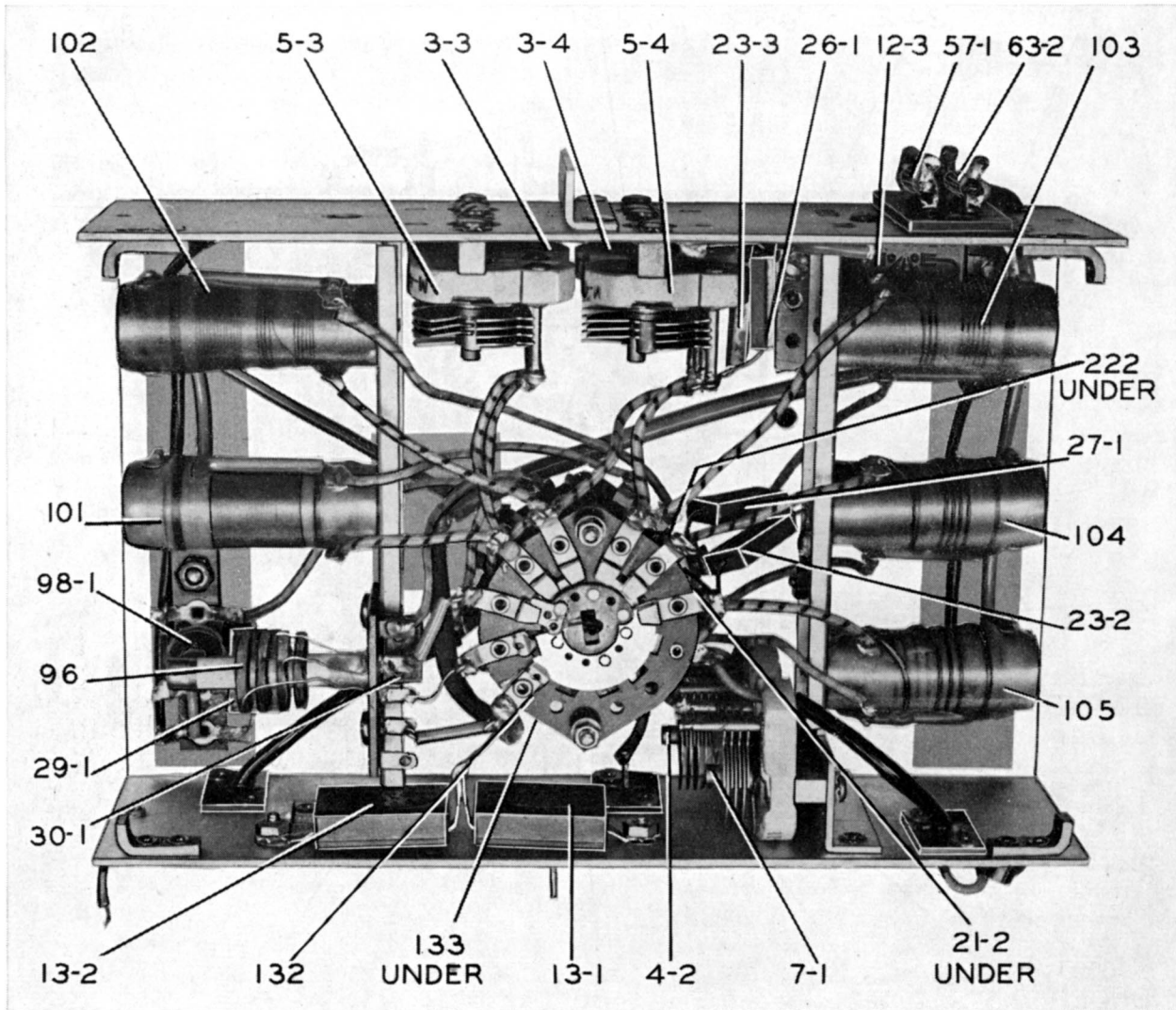

FIGURE 18—R-F UNIT

connected through a 0.1 mfd. capacitor to the second detector diode socket prong and to ground. A signal response indicates proper functioning. Coupling the test oscillator to the grid of the third i-f should indicate a decided gain in sensitivity. Proceeding similarly towards the first detector,

915 kc. to the first detector grid and adjusting the i-f tuning cores of both primary and secondary windings of the first, second, third and fourth i-f transformers and the tuned circuit of the crystal filter assembly for maximum output. The fourth i-f transformer is slightly over-coupled with a resultant flat top.

(9) *Check and Alignment of C-W Oscillator*

The c-w oscillator is checked and adjusted by coupling the 915 kc. input (modulation off) to the grid of the first detector tube and then switching the c-w oscillator "ON." With the beat frequency control set at mid-position, the oscillator inductance tuning core

(10) *Test and Adjustment of Crystal Band Pass Filter*

Normally the crystal band pass filter is adjusted at the factory for a band width of 1500 to 2,000 cycles at 10X down from resonance. This filter can be tested by applying an unmodulated signal of approximately

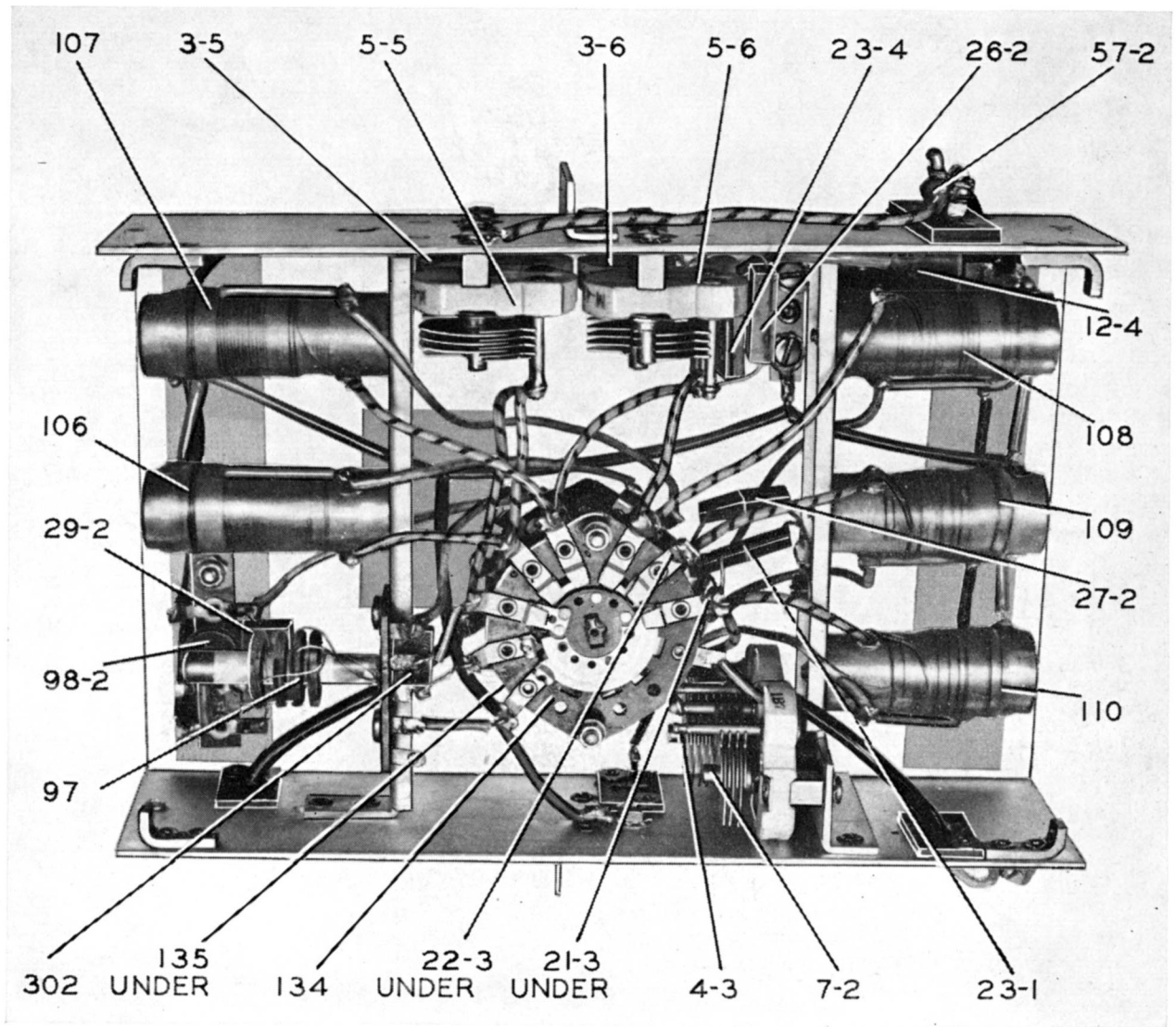

FIGURE 19—DETECTOR UNIT

121 is adjusted for zero beat. If no c-w beat can be heard, the c-w oscillator circuit should be checked for grounds, shorts, or defective components. With the c-w oscillator "ON" the screen voltage at the first and second i-f sockets drops to approximately 45 volts (measured to ground).

915 kc. connected through a 0.1 mfd. capacitor to the grid of the first detector tube and ground. The c-w oscillator should be off during this test. To adjust the band width of the crystal filter, a signal generator or microvolter having an expanded tuning scale in the vicinity of 915 kc. and having also an



Par. 35

attenuator with a multiplier of 10 times (20db) is required. The following procedure is recommended: Connect a microammeter with a range of approximately 200 microamperes in series with the cathode return of the "AVC" volume control (79-B white lead). Throw the crystal switch to the "IN" posi-

meter is symmetrical and free from dips or peaks except for the main resonance peak of the crystal. The band width with an input voltage ratio of 10X is adjusted to approximately 2 kc. by slight realignment of the secondary (top) tuning core of the 1st I-F Transformer (251). After concluding the

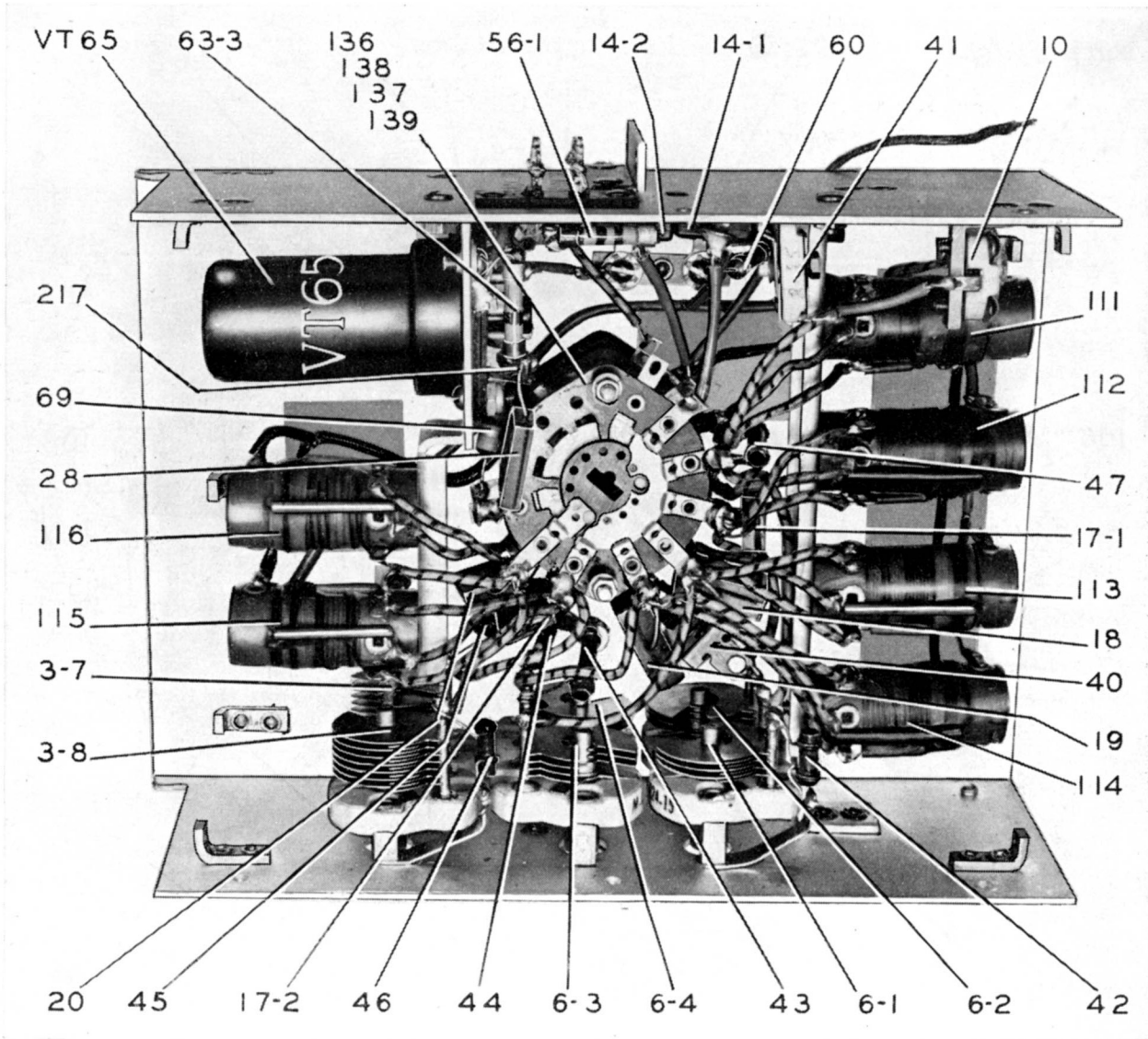

FIGURE 20—OSCILLATOR UNIT

tion, and with the unmodulated 915 kc. input from the test oscillator find the resonance peak of the crystal by slightly retuning the test oscillator until maximum deflection is indicated on the microammeter. The phasing control (8) is adjusted until the resonance curve as indicated on the microam-

above described tests, remove the microammeter and restore the circuit to normal.

(11) *Check of Heterodyne Oscillator*

Having checked the functioning of the i-f and audio amplifiers, if signals are not heard on any band, the heterodyne oscillator should

be checked for oscillation. This can be done by observing the cathode voltages at the socket of the first detector Tube VT-91 when grounding the stator of the oscillator section (I-D) of the tuning capacitor. If no change in voltage is noted with this test, the oscillator circuit should be checked for grounds, shorts or defective components.

(12) *Test of the R-F Amplifier*

Having completed the test and alignment of the audio amplifier, i-f amplifier and heterodyne oscillator, the r-f amplifier is tested as follows :

With the band switch set on the band lacking sensitivity, a modulated signal from the test oscillator is capacitively coupled through a 100 mmf. dummy antenna to the antenna post and to ground. This input signal frequency should be set quite accurately to the alignment frequency shown in the "Table of Alignment Data" for the band under test. With the tuning control set for the approximate alignment frequency, tune slowly around this point until the maximum response with the least signal input is obtained. Capacitively coupling the test oscillator to the grid of the first r-f and second r-f tubes should show a progressive decrease in output indicating the proper functioning of the particular r-f stage or circuits preceding. If a decrease in response is noted when the signal input is capacitively coupled progressively from the grid of the first detector to the second and first r-f grid caps and finally to the antenna post (with the 100 mmf. dummy antenna capacitor), the stage which indicates a decrease in response should be checked for circuit, ground, shorts or defective components.

(13) *Alignment of R-F Amplifier*

NOTE: For a general alignment start with the 200-500 kc. Band No. 1.

In the r-f alignment for any particular band the tuning control is adjusted for the alignment frequency (Table of Alignment Data), and the modulated test signal at this align-

ment frequency is coupled from the test oscillator to antenna post through the 100 mmf. dummy antenna. The three r-f trimmers (Ant.; RF.; and Det.) for this band, are then adjusted for maximum output. A similar procedure is followed in the alignment of each band.

(14) *Alignment of Heterodyne Oscillator*

NOTE: For a general alignment start with the 200-500 kc. Band No. 1.

The alignment of the Heterodyne Oscillator is necessary only when the tuning dial frequency calibration is in error by more than 0.5 per cent. To align the oscillator follow the same general procedure as was followed for the alignment of the r-f amplifier. With the Band Switch on Band No. 1 (200-500 kc.) and the Tuning Control set to the alignment frequency, couple the output of the modulated test oscillator (set at the alignment frequency) to the antenna post through the 100 mmf. dummy antenna. The oscillator trimmer for this band is adjusted for maximum audio output. Note that in Band No. 1 there are two such adjustments one at the L.F. and the other at the H.F. end of the dial. A similar procedure is followed in the alignment of each band.

*d Weak or No Signals on Any One Band, Modulated Reception*

The condition of satisfactory reception on several bands and weak or no signals on one or more bands, indicates the correct functioning of the i-f and a-f amplifiers and requires checking only the r-f amplifier and heterodyne oscillator for the defective band or bands. The procedure outlined in paragraphs 35c (11) to 35c (14) should be followed for the defective band or bands.

*e Weak or No Signals on All Bands, C-W Reception (Modulated Reception Normal)*

Weak or no signals on all bands for c-w reception with satisfactory modulated signal reception requires testing and alignment of the c-w oscillator. Proceed as outlined in paragraphs 35c (8) and 35c (9).

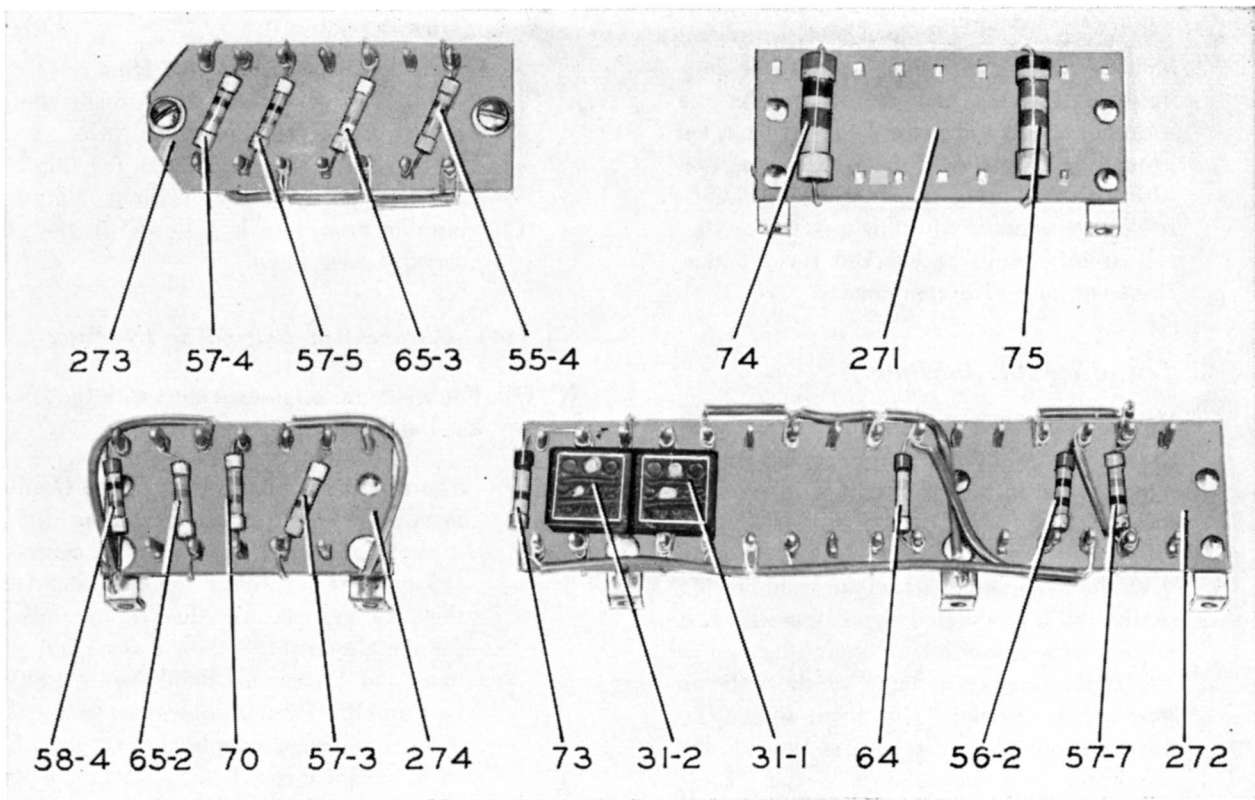

FIGURE 21—RADIO RECEIVER BC-348-H: RESISTOR BOARDS, VIEW A

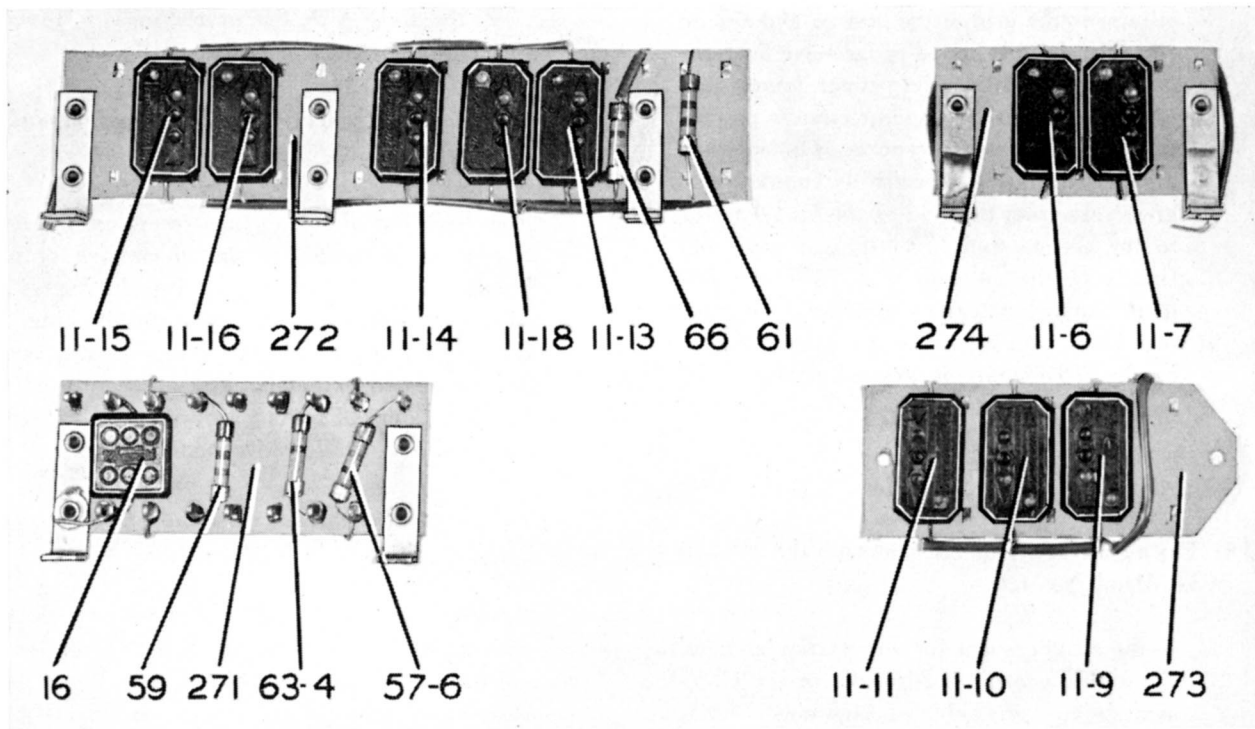

FIGURE 22—RADIO RECEIVER BC-348-H: RESISTOR BOARDS, VIEW B

Test	Tube	Function	Block Terminal Number to	Analyzer Jacks	
Plate Voltage	VT-86	RF & IF Ampl. } VT-91 1st Det. } VT-93 3rd IF } VT-65 RF Osc. } VT-152 Output }	3 gnd	250 V ± V	
	VT-70	2nd IF	2 gnd	250 V ± V	
	Screen Voltage	VT-86	RF & IF Ampl. } VT-91 1st Det. } VT-152 Output }	4 gnd	250 V ± V
		VT-70	2nd IF Cw-Osc.	3 gnd	250 V ± V
		VT-93	3rd IF	6 gnd	250 V ± V
Cathode Voltage	VT-86	RF & IF Ampl. } VT-91 1st Det. } VT-65 RF Osc. } VT-152 Output }	8 gnd	10 V ± V	
	VT-70	2nd IF Cw-Osc.	6 gnd	10 V ± V	
	VT-93	3rd IF, 2nd Det.	8 gnd	25 V ± V	
	Heater Voltage	VT-65	RF Osc. } VT-86 1st RF, 2nd RF } VT-91 1st Det. } VT-93 3rd IF }	7 2	10 V ± V
		VT-86	1st IF	2 7	10 V ± V
VT-70		2nd IF	1 7	10 V ± V	
VT-152		Output	7 2	10 V ± V	
Triode Voltage		VT-70	CW Osc.	4 gnd	250 V ± V
Diode Voltage	VT-93	2nd Det.	5 gnd	100 V ± V	
Plate Current	VT-86	RF & IF Ampl. } VT-91 1st Det. } VT-65 RF Osc. } VT-93 3rd IF, 2nd Det. }	3 Outside 3 Inside	10 ma. — ma.	
	VT-152	Output	3 Outside 3 Inside	25 ma. — ma.	
	VT-70	2nd IF CW-Osc.	2 Outside 2 Inside	5 ma. — ma.	
	Screen Current	VT-86	RF & IF Ampl. } VT-91 1st Det. } VT-152 Output }	4 Outside 4 Inside	5 ma. — ma.
		VT-70	2nd IF CW-Osc.	3 Outside 3 Inside	5 ma. — ma.
VT-93		3rd IF, 2nd Det.	6 Outside 6 Inside	1 ma. — ma.	

**Par. 35**

*f Measurements With Test Set I-56-A.*

GENERAL—The following readings are typical values obtained on the Weston Model 665-2 Selective Analyzer (Test Set I-56-A). If all plugs seem to be securely in position with the dynamotor running and faulty or poor operation is obtained from the receiver, a careful check should first be made of the cables and plugs using the Model 564 Volt-Ohmmeter as outlined under "Detailed Tests on Radio Sets," page 11 of the Instruction Book for Test Set I-56-A. If all plug-in cable connections seem to be functioning properly, a test should be made of the tubes in the receiver, using the Model 685 tube tester as outlined in the paragraphs mentioned above. Should neither of these tests locate the difficulty, voltage and current or resistance measurements should be made as outlined in the following paragraphs:

(1) *Voltage and Current Measurements*

Set up the receiver and a Model 665 analyzer for operation as outlined under general volt-

- (b) Power connections should be made to the plug socket at the rear of the receiver chassis.
- (c) Be sure the plug and tube top grid connections are secure when taking readings.
- (d) Keep the analyzer "AC-DC" switch on "DC."
- (e) Place the analyzer left-hand toggle switch in the "VOLTS-MA" position.
- (f) Connect the short jumper cables for the various tests as indicated in table below.
- (g) Connect jumper cable from black terminal "GND" to receiver chassis.
- (h) Set the receiver control switch on the "MVC" position unless otherwise specified.
- (i) Set the receiver with the volume control at the maximum position (extreme clockwise).

**Table of Alignment Data**

Band No.	Freq. Range	Alignment Frequency	Osc.	Trimmers* Det.	R.F.	Ant.
1	200- 500 kc.	{ 500 kc. 200 kc.	6-1 10	3-5	3-3	2**
2	1.5- 3.5 mc.	3.5 mc.	6-2	5-5	5-3	5-1
3	3.5- 6.0 mc.	6.0 mc.	6-3	3-6	3-4	3-1
4	6.0- 9.5 mc.	9.5 mc.	6-4	5-6	5-4	5-2
5	9.5-13.5 mc.	13.5 mc.	3-7	7-2	7-1	3-2
6	13.5-18.0 mc.	18.0 mc.	3-8	4-3	4-2	4-1

\*Refer to Schematic Diagram and marked photographs for location. The alignment controls for the various bands are numbered on the chassis adjacent to the control. Controls for band 1 are marked 1, those for 2 are marked 2, etc.

\*\*Antenna alignment control.

age and current measurements. To obtain the various readings, connect the jumper leads from the socket selector block to the analyzer pin jacks in accord with the instructions given below.

*Procedure*

- (a) Release the thumb screws and pull the complete chassis out of the case.

- (j) Set the tuning control to 200 kc. (L-F end of Band 1); readings should deviate but slightly when switching to other bands with the tuning control remaining at the low frequency end of each band.
- (k) The c-w oscillator should be "OFF" for the readings in Table A and "ON" for the readings in Table B.

(2) *Resistance and Continuity Measurements*

Remove the chassis from the cabinet and do not make any connections to the plug socket at the rear of the chassis. This procedure permits the operation of all switches without running the dynamotor and causing voltages to be built up across the various resistors and condensers. Any voltages set up by the dynamotor in the receiver would cause serious

at the maximum position (extreme clockwise).

- (c) Set the tuning control to 200 kc. (LF end of Band 1); readings should not deviate when switching to other bands with the tuning control remaining at the low-frequency end of each band.
- (d) The c-w oscillator should be "OFF" for

Note: The readings given below are average values taken on receivers of this type using a 28 volt power supply. Meter indications within  $\pm 10\%$  of these values will in most cases indicate correct operations. The readings are taken with the tuning control set to the L.F. end of the dial.

TABLE A. C-W OSC. "OFF"

Stage	Tube	Plate Volts	Screen Volts	Cathode Volts	Heater Volts	M. A. Plate Current	M. A. Screen Current
1 RF.	VT-86	184	70	2.6	6.3	4.1	1.0
2 RF.	VT-86	177	86	3.2	6.3	4.8	1.3
1 Det.	VT-91	202	96	4.2	6.3	0.23	0.08
Osc.	VT-65	58	..	0.0	6.3	1.6	..
1 IF.	VT-86	182	82	3.1	6.5	4.7	1.2
2 IF.	VT-70	207	82	3.1	6.5	4.5	1.4
3 IF.	VT-93	207	72	21.0	6.5	2.5	0.6
Output	VT-152	197	207	0.0	6.5	18.0	3.2
2 Det	VT-93 Diode	8.0					

TABLE B. C-W OSC. "ON"

Stage	Tube	Plate Volts	Screen Volts	Cathode Volts	Heater Volts	M. A. Plate Current	M. A. Screen Current
1 RF.	VT-86	197	37	1.3	6.3	2.0	0.55
2 RF.	VT-86	188	65	2.3	6.3	3.7	1.0
1 Det.	VT-91	204	72	3.4	6.3	0.17	0.06
Osc.	VT-65	58	..	0.0	6.3	1.6	..
1 IF.	VT-86	195	44	1.6	6.5	2.3	0.5
2 IF.	VT-70	210	44	1.6	6.5	2.2	0.5
3 IF.	VT-93	210	72	21.0	6.5	2.5	0.6
Output	VT-152	198	210	0.0	6.5	23.5	3.6
CW Osc.	VT-70 Triode	18.0					

errors in reading on the ohmmeter ranges or might possibly damage the test instruments.

*Procedure*

- (a) Set the receiver control switch to "MVC" unless otherwise specified.
- (b) Set the receiver with the volume control

the readings in Table C and "ON" for the readings in Table D.

- (e) Shift the analyzer left-hand toggle switch to the ohms position.

Set up the Model 665 Analyzer for resistance and continuity measurements as outlined under "General Resistance and Continuity Tests"

Par. 35

in the Test Set instruction book. Before taking a resistance reading on any range, short the two jumper leads plugged into the ohmmeter pin jacks and rotate the "battery adjustment" knob until the instrument pointer reads exactly full scale. Should it be found impossible to bring the pointer up to the top mark refer to the paragraphs on battery replacement under the heading "Maintenance" in the Test Set instruction book. Plug the pin tip end of the 3 foot clip lead into the block hole marked "GND" and clip the other end to the chassis. Connect one of the jumper leads between the remaining ground jack and

one of the ohmmeter jacks on the required range. Connect the other jumper lead from the remaining ohmmeter range jack to the tube element under test. In general, ohmmeter readings will be most accurate when taken on the upper  $\frac{2}{3}$  of the scale, and, wherever possible, the range should be chosen that will give indications in this area.

g *Failure of Dial Lights*

The two dial lamps are connected in series; hence the failure of either lamp does not indicate failure of both lamps. Removal of the dial light housing gives ready access to the lamps.

NOTE: The readings tabulated below are average values taken on receivers of this type with the storage battery disconnected. Meter indications within plus or minus 10% of these values will in most cases indicate correct operation.

Resistance to Ground (OHMS)

TABLE C. C-W OSC. "OFF"

Stage	Tube	Cathode	Plate	Screen	"MVC" Grid	"AVC" Grid
1 RF.	VT-86	490	5,200	80,000	100,000	1.8 meg.
2 RF.	VT-86	480	5,200	75,000	100,000	1.8 meg.
1 Det.	VT-91	15,000	5,600	75,000	0	0
Osc.	VT-65	0	41,000	.....	100,000	100,000
1 IF.	VT-86	520	5,600	70,000	500,000	1.8 meg.
2 IF.	VT-70	470	500	70,000	500,000	2.25 meg.
3 IF.	VT-93	6,200	500	180,000	5,000	5,000
Output	VT-152	0	1,080	480	700,000	

TABLE D. C-W OSC. "ON"

1 RF.	VT-86	490	5,200	20,000	100,000	1.8 meg.
2 RF.	VT-86	480	5,200	23,000	100,000	1.8 meg.
1 Det.	VT-91	15,000	5,600	23,000	0	0
Osc.	VT-65	0	41,000	.....	100,000	100,000
1 IF.	VT-86	520	5,600	9,200	500,000	1.8 meg.
2 IF.	VT-70	470	500	9,200	500,000	2.25 meg.
3 IF.	VT-93	6,200	500	180,000	5,000	5,000
Output	VT-152	0	1,080	480	700,000	.....
C-W Osc.	VT-70	.....	82,000	.....	500,000	.....
Det. Diode	VT-93	.....	180,000	.....	.....	.....
AVC Diode	VT-93	.....	380,000	.....	.....	.....

## SECTION V

NOTE: In the List of Replaceable Parts, those parts having identical part numbers followed by letters are constructed as common assemblies.

The following symbols are used in columns 4 and 6 of the List of Replaceable Parts to indicate the part manufacturer. Where no manufacturer is indicated, the part is manufactured by the Belmont Radio Corporation.

<b>Manufacturer</b>	<b>Symbol</b>	<b>Manufacturer</b>	<b>Symbol</b>
Aladdin Radio Industries .....	AR	General Electric Co. ....	GE
Allen Bradley Co. ....	AB	International Resistance Corp. ....	IRC
Arrow Hart & Hegeman Corp. ....	AH	Littelfuse Laboratories, Inc. ....	LL
American Radio Hardware Co. ....	ARH	P. R. Mallory Co. ....	PRM
Bliley Electric Co. ....	BE	Micamold Radio Corp. ....	MR
Central Radio Laboratory .....	CRL	National Lock Co. ....	NL
Chicago Transformer Co. ....	CT	National Fabricated Products, Inc. ....	NF
H. Cole and F. C. Hersee Co. ....	CH	Oak Mfg. Co. ....	OM
Cornell Dubilier Corp. ....	CD	Radio Condenser Corp. ....	RC
Crowe Nameplate Mfg. Co. ....	CN	Radio Corporation of America .....	RCA
Drake Mfg. Co. ....	DM	Ross Mfg. Co. ....	RM
Eicor, Inc. ....	E	Solar Mfg. Co. ....	SM
Erie Resistor Corp. ....	ER	Sprague Specialties Corp. ....	SS
John E. Fast Co. ....	JF	Wincharger Corp. ....	WC



**TABLE OF REPLACEABLE PARTS**  
**BC-348-H**

Reference No.	Stock No.	Name of Part	Description	Function	Drawing No.
1-A		Capacitor	A Section, 16 to 241 mmfd	Main Tuning	C-8A-282 RC
1-B			B Section, 16 to 241 mmfd		
1-C			C Section, 16 to 241 mmfd		
1-D			D Section, 16 to 241 mmfd		
2		Capacitor	Air Trimmer 75 mmfd max.	Ant. Aligning	A-8H-500 RC or OM
3-1		Capacitor	Air Trimmer 50 mmfd max.	Ant. Trimmer	A-8H-495 RC or OM
3-2		Capacitor	Air Trimmer 50 mmfd max.	Ant. Trimmer	A-8H-495 RC or OM
3-3		Capacitor	Air Trimmer 50 mmfd max.	R. F. Trimmer	A-8H-495 RC or OM
3-4		Capacitor	Air Trimmer 50 mmfd. max.	R. F. Trimmer	A-8H-495 RC or OM
3-5		Capacitor	Air Trimmer 50 mmfd max.	Det. Trimmer	A-8H-495 RC or OM
3-6		Capacitor	Air Trimmer 50 mmfd max.	Det. Trimmer	A-8H-495 RC or OM
3-7		Capacitor	Air Trimmer 50 mmfd max.	Osc. Trimmer	A-8H-495 RC or OM
3-8		Capacitor	Air Trimmer 50 mmfd max.	Osc. Trimmer	A-8H-495 RC or OM
4-1		Capacitor	Air Trimmer 50 mmfd max.	Ant. Trimmer	A-8H-496 RC or OM
4-2		Capacitor	Air Trimmer 50 mmfd max.	R. F. Trimmer	A-8H-496 RC or OM
4-3		Capacitor	Air Trimmer 50 mmfd max.	Det. Trimmer	A-8H-496 RC or OM
5-1		Capacitor	Air Trimmer 25 mmfd max.	Ant. Trimmer	A-8H-497 RC or OM
5-2		Capacitor	Air Trimmer 25 mmfd max.	Ant. Trimmer	A-8H-497 RC or OM
5-3		Capacitor	Air Trimmer 25 mmfd max.	R. F. Trimmer	A-8H-497 RC or OM
5-4		Capacitor	Air Trimmer 25 mmfd max.	R. F. Trimmer	A-8H-497 RC or OM
5-5		Capacitor	Air Trimmer 25 mmfd max.	Det. Trimmer	A-8H-497 RC or OM
5-6		Capacitor	Air Trimmer 25 mmfd max.	Det. Trimmer	A-8H-497 RC or OM

**TABLE OF REPLACEABLE PARTS—Continued**  
**BC-348-H**

Reference No.	Stock No.	Name of Part	Description	Function	Drawing No.
6-1		Capacitor	Air Trimmer 25 mmfd max.	Osc. Trimmer	A-8H-501 RC or OM
6-2		Capacitor	Air Trimmer 25 mmfd max.	Osc. Trimmer	A-8H-501 RC or OM
6-3		Capacitor	Air Trimmer 25 mmfd max.	Osc. Trimmer	A-8H-501 RC or OM
6-4		Capacitor	Air Trimmer 25 mmfd max.	Osc. Trimmer	A-8H-501 RC or OM
7-1		Capacitor	Air Trimmer 25 mmfd max.	R. F. Trimmer	A-8H-716 RC or OM
7-2		Capacitor	Air Trimmer 25 mmfd max.	Det. Trimmer	A-8H-716 RC or OM
8		Capacitor	Air Trimmer 10 mmfd max.	Crystal Filter Adjustment	A-8H-499 RC or OM
9		Capacitor	Air Trimmer 10 mmfd max.	C. W. Osc. Adjustment	A-8H-498 RC or OM
10		Capacitor	Ceramic Trimmer 5 to 30 mmfd	Osc. Series Pad.	A-8G-738 ER
11-1		Capacitor	Paper 500 volts DC .01 mfd $\pm$ 10% with leads	1st R. F. Cathode By-pass	B-8J-696 MR
11-2		Capacitor	Paper 500 volts DC .01 mfd $\pm$ 10% with leads	1st R. F. Screen By-pass	B-8J-696 MR
11-3		Capacitor	Paper 500 volts DC .01 mfd $\pm$ 10% with leads	2nd R. F. Cathode By-pass	B-8H-696 MR
11-4		Capacitor	Paper 500 volts DC .01 mfd $\pm$ 10% with leads	2nd R. F. Screen By-pass	B-8J-696 MR
11-5		Capacitor	Paper 500 volts DC .01 mfd $\pm$ 10% with leads	1st DET. Screen By-pass	B-8J-696 MR
11-6		Capacitor	Paper 500 volts DC .01 mfd $\pm$ 10% with leads	1st I. F. Trans- former By-pass	B-8J-696 MR
11-7		Capacitor	Paper 500 volts DC .01 mfd $\pm$ 10% with leads	Crystal Trans- former By-pass	B-8J-696 MR
11-8		Capacitor	Paper 500 volts DC .01 mfd $\pm$ 10% with leads	1st I. F. Cathode By-pass	B-8J-696 MR
11-9		Capacitor	Paper 500 volts DC .01 mfd $\pm$ 10% with leads	1st I. F. Plate By-pass	B-8J-696 MR

**TABLE OF REPLACEABLE PARTS—Continued**  
**BC-348-H**

Reference No.	Stock No.	Name of Part	Description	Function	Drawing No.
11-10		Capacitor	Paper 500 volts DC .01 mfd $\pm 10\%$ with leads	2nd I. F. By-pass	B-8J-696 MR
11-11		Capacitor	Paper 500 volts DC .01 mfd $\pm 10\%$ with leads	2nd I. F. Cathode By-pass	B-8J-696 MR
11-12		Capacitor	Paper 500 volts DC .01 mfd $\pm 10\%$ with leads	C. W. Osc. Plate By-pass	B-8J-696 MR
11-13		Capacitor	Paper 500 volts DC .01 mfd $\pm 10\%$ with leads	Plug Terminal By-pass	B-8J-696 MR
11-14		Capacitor	Paper 500 volts DC .01 mfd $\pm 10\%$ with leads	AVC By-pass	B-8J-696 MR
11-15		Capacitor	Paper 500 volts DC .01 mfd $\pm 10\%$ with leads	3rd I. F. Trans- former By-pass	B-8J-696 MR
11-16		Capacitor	Paper 500 volts DC .01 mfd $\pm 10\%$ with leads	3rd I. F. Cathode By-pass	B-8J-696 MR
11-17		Capacitor	Paper 500 volts DC .01 mfd $\pm 10\%$ with leads	Heater By-pass	B-8J-696 MR
11-18		Capacitor	Paper 500 volts DC .01 mfd $\pm 10\%$ with leads	Battery By-pass	B-8J-696 MR
12-1		Capacitor	Mica 500 volts DC .01 mfd $\pm 10\%$ with lugs	Ant. Coil By-pass	B-8F-363 CD or SM
12-2		Capacitor	Mica 500 volts DC .01 mfd $\pm 10\%$ with lugs	Ant. Coil By-pass	B-8F-363 CD or SM
12-3		Capacitor	Mica 500 volts DC .01 mfd $\pm 10\%$ with lugs	1st R. F. Plate By-pass	B-8F-363 CD or SM
12-4		Capacitor	Mica 500 volts DC .01 mfd $\pm 10\%$ with lugs	2nd R. F. Plate By-pass	B-8F-363 CD or SM
13-1		Capacitor	Mica 500 volts DC .01 mfd $\pm 10\%$ with lugs	R. F. Coil By-pass	B-8F-737 CD or SM
13-2		Capacitor	Mica 500 volts DC .01 mfd $\pm 10\%$ with lugs	R. F. Coil By-pass	B-8F-737 CD or SM

**TABLE OF REPLACEABLE PARTS—Continued**  
**BC-348-H**

Reference No.	Stock No.	Name of Part	Description	Function	Drawing No.
14-1		Capacitor	Mica 500 volts DC .01 mfd $\pm 10\%$ with lugs	1st Det. Cathode By-pass	B-8F-741 CD or SM
14-2		Capacitor	Mica 500 volts DC .01 mfd $\pm 10\%$ with lugs	Osc. Plate By-pass	B-8F-741 CD or SM
15		Capacitor	Mica 500 volts DC .01 mfd $\pm 10\%$ with leads	Antenna Series Pad	B-8F-506 CD or SM
16		Capacitor	Mica 500 volts DC .005 mfd $\pm 10\%$ with leads	Audio Frequency Secondary By-pass	B-8F-512 MR or SM
17-1		Capacitor	Mica 500 volts DC 500 mmfd $\pm 1\frac{1}{2}\%$ with leads	Osc. Series	B-8F-744 MR or SM
17-2		Capacitor	Mica 500 volts DC 500 mmfd $\pm 1\frac{1}{2}\%$ with leads	Osc. Series	B-8F-744 MR or SM
18		Capacitor	Mica 500 volts DC 1700 mmfd $\pm 2\%$ with leads	Osc. Series	B-8F-745 MR or SM
19		Capacitor	Mica 500 volts DC 2650 mmfd $\pm 2\%$ with leads	Osc. Series	B-8F-746 MR or SM
20		Capacitor	Mica 500 volts DC 210 mmfd $\pm 1\frac{1}{2}\%$ with leads	Osc. Series	B-8F-747 MR or SM
21-1		Capacitor	Mica 500 volts DC 200 mmfd $\pm 1\%$ with leads	Ant. Series	B-8F-734 MR or SM
21-2		Capacitor	Mica 500 volts DC 200 mmfd $\pm 1\%$ with leads	R. F. Series	B-8F-734 MR or SM
21-3		Capacitor	Mica 500 volts DC 200 mmfd $\pm 1\%$ with leads	Det. Series	B-8F-734 MR or SM
22-1		Capacitor	Mica 500 volts DC 400 mmfd $\pm 1\frac{1}{2}\%$ with leads	Ant. Series	B-8F-735 MR or SM
22-2		Capacitor	Mica 500 volts DC 400 mmfd $\pm 1\frac{1}{2}\%$ with leads	R. F. Series	B-8F-735 MR or SM
22-3		Capacitor	Mica 500 volts DC 400 mmfd $\pm 1\frac{1}{2}\%$ with leads	Det. Series	B-8F-735 MR or SM

**TABLE OF REPLACEABLE PARTS—Continued**  
**BC-348-H**

Reference No.	Stock No.	Name of Part	Description	Function	Drawing No.
23-1		Capacitor	Mica 500 volts DC 40 mmfd $\pm 5\%$ with leads	Det. Shunt	B-8F-732 MR or SM
23-2		Capacitor	Mica 500 volts DC 40 mmfd $\pm 5\%$ with leads	R. F. Shunt	B-8F-732 MR or SM
23-3		Capacitor	Mica 500 volts DC 40 mmfd $\pm 5\%$ with leads	R. F. Shunt	B-8F-732 MR or SM
23-4		Capacitor	Mica 500 volts DC 40 mmfd $\pm 5\%$ with leads	Det. Shunt	B-8F-732 MR or SM
24-1		Capacitor	Mica 500 volts DC 25 mmfd $\pm 5\%$ with leads	Ant. Shunt	B-8F-755 MR or SM
24-2		Capacitor	Mica 500 volts DC 25 mmfd $\pm 5\%$ with leads	Ant. Shunt	B-8F-755 MR or SM
25		Capacitor	Mica 500 volts DC 65 mmfd $\pm 5\%$ with leads	Ant. Shunt	B-8F-756 MR or SM
26-1		Capacitor	Mica 500 volts DC 95 mmfd $\pm 5\%$ with leads	R. F. Shunt	B-8F-733 MR or SM
26-2		Capacitor	Mica 500 volts DC 95 mmfd $\pm 5\%$ with leads	Det. Shunt	B-8F-733 MR or SM
27-1		Capacitor	Mica 500 volts DC 70 mmfd $\pm 5\%$ with leads	R. F. Shunt	B-8F-736 MR or SM
27-2		Capacitor	Mica 500 volts DC 70 mmfd $\pm 5\%$ with leads	Det. Shunt	B-8F-736 MR or SM
28		Capacitor	Mica 500 volts DC 100 mmfd $\pm 5\%$ with leads	Osc. Grid	B-8F-743 MR or SM
29-1		Capacitor	Mica 500 volts DC 1250 mmfd $\pm 10\%$ with leads	R. F. Primary Shunt	B-8F-776 MR or SM
29-2		Capacitor	Mica 500 volts DC 1250 mmfd $\pm 10\%$ with leads	Det. Primary Shunt	B-8F-776 MR or SM
30-1		Capacitor	Mica 500 volts DC 2 mmfd $\pm \frac{1}{2}$ mmfd with leads	R. F. Coupling	A-8G-754 MR or SM

**TABLE OF REPLACEABLE PARTS—Continued**  
**BC-348-H**

Reference No.	Stock No.	Name of Part	Description	Function	Drawing No.
30-2		Capacitor	Mica 500 volts DC 2 mmfd $\pm \frac{1}{2}$ mmfd with leads	Det. Coupling	A-8G-754 MR or SM
31-1		Capacitor	Mica 500 volts DC 1500 mmfd $\pm 10\%$ with leads	Audio Coupling	B-8F-514 MR or SM
31-2		Capacitor	Mica 500 volts DC 1500 mmfd $\pm 10\%$ with leads	Audio Transformer Primary Shunt	B-8F-514 MR or SM
32		Capacitor	Mica 500 volts DC 200 mmfd $\pm 5\%$ with leads	1st I. F. Primary Tuning	B-8F-828 MR or SM
33		Capacitor	Mica 500 volts DC 300 mmfd $\pm 5\%$ with leads	1st I. F. Secondary Tuning	B-8F-829 MR or SM
34-1		Capacitor	Mica 500 volts DC 260 mmfd $\pm 5\%$ with leads	Crystal Trans- former Tuning	B-8F-675 MR or SM
34-2		Capacitor	Mica 500 volts DC 260 mmfd $\pm 5\%$ with leads	3rd I. F. Primary	B-8F-675 MR or SM
34-3		Capacitor	Mica 500 volts DC 260 mmfd $\pm 5\%$ with leads	3rd I. F. Secondary Tuning	B-8F-675 MR or SM
35-1		Capacitor	Mica 500 volts DC 240 mmfd $\pm 5\%$ with leads	2nd I. F. Primary Tuning	B-8F-692 MR or SM
35-2		Capacitor	Mica 500 volts DC 240 mmfd $\pm 5\%$ with leads	2nd I. F. Secondary Tuning	B-8F-692 MR or SM
35-3		Capacitor	Mica 500 volts DC 240 mmfd $\pm 5\%$ with leads	C. W. Osc. Tuning	B-8F-692 MR or SM
35-4		Capacitor	Mica 500 volts DC 240 mmfd $\pm 5\%$ with leads	2nd Det. By-pass	B-8F-692 MR or SM
36		Capacitor	Mica 500 volts DC 47 mmfd $\pm 5\%$ with leads	4th I. F. Primary Tuning	B-8F-827 MR or SM
37-1		Capacitor	Mica 500 volts DC 150 mmfd $\pm 5\%$ with leads	4th I. F. Secondary Tuning	B-8F-674 MR or SM
37-2		Capacitor	Mica 500 volts DC 150 mmfd $\pm 5\%$ with leads	C. W. Osc. Grid	B-8F-674 MR or SM

**TABLE OF REPLACEABLE PARTS—Continued**  
**BC-348-H**

Reference No.	Stock No.	Name of Part	Description	Function	Drawing No.
38		Capacitor	Mica 500 volts DC 75 mmfd $\pm 5\%$ with leads	Diode Coupling	B-8F-693 MR or SM
39		Capacitor	Mica 500 volts DC 750 mmfd $\pm 5\%$ with leads	1st I. F. Secondary Tuning	B-8F-830 MR or SM
40		Capacitor	Mica 500 volts DC 6 mmfd $\pm .2$ mmfd with lugs	Osc. Temperature Compensating	B-8F-740 UE
41		Capacitor	Mica 500 volts DC 3.8 mmfd $\pm .2$ mmfd with lugs	Osc. Temperature Compensating	B-8F-739 UE
42		Capacitor	Ceramic 500 volts DC 20 mmfd $\pm$ 5% with leads	Osc. Temperature Compensating	A-8G-748 CRL
43		Capacitor	Ceramic 500 volts DC 65 mmfd $\pm$ 5% with leads	Osc. Temperature Compensating	A-8G-749 CRL
44		Capacitor	Ceramic 500 volts DC 90 mmfd $\pm$ 3% with leads	Osc. Temperature Compensating	A-8G-750 CRL
45		Capacitor	Ceramic 500 volts DC 35 mmfd $\pm$ 5% with leads	Osc. Temperature Compensating	A-8G-751 CRL
46		Capacitor	Ceramic 500 volts DC 40 mmfd $\pm$ 5% with leads	Osc. Temperature Compensating	A-8G-752 CRL
47		Capacitor	Ceramic 500 volts DC 85 mmfd $\pm$ 3% with leads	Osc. Series	A-8G-753 CRL
48-1A		Capacitor	Paper 250 volts DC .5 mfd $\pm 15\%$	4th I. F. Trans- former Filter	A-8B-516 SM or SS
48-1B		Capacitor	Paper 250 volts DC .5 mfd $\pm 15\%$	Noise Compensator Filter	A-8B-516 SM or SS
48-2A		Capacitor	Paper 250 volts DC .5 mfd $\pm 15\%$	Screen Supply Filter	A-8B-516 SM or SS
48-2B		Capacitor	Paper 250 volts DC .5 mfd $\pm 15\%$	Output Plate Filter	A-8B-516 SM or SS
48-3A		Capacitor	Paper 250 volts DC .5 mfd. $\pm 15\%$	Volume Control Filter	A-8B-515 SM or SS
48-3B		Capacitor	Paper 250 volts DC .5 mfd $\pm 15\%$	3rd I. F. Screen Filter	A-8B-515 SM or SS
49-1A		Capacitor	Paper 250 volts DC .5 mfd. $\pm 15\%$	4th I. F. Trans- former Filter	A-8B-515 SM or SS

**TABLE OF REPLACEABLE PARTS—Continued**  
**BC-348-H**

Reference No.	Stock No.	Name of Part	Description	Function	Drawing No.
49-1B		Capacitor	Paper 250 volts DC .5 mfd $\pm 15\%$	4th I. F. Transformer Filter	A-8B-515 SM or SS
49-2A		Capacitor	Paper 250 volts DC .5 mfd $\pm 15\%$	Output Grid Filter	A-8B-515 SM or SS
49-2B		Capacitor	Paper 250 volts DC .5 mfd $\pm 15\%$	Screen Supply Filter	A-8B-515 SM or SS
49-3A		Capacitor	Paper 250 volts DC .5 mfd. $\pm 15\%$	1st I. F. Screen Filter	A-8B-516 SM or SS
49-3B		Capacitor	Paper 250 volts DC .5 mfd $\pm 15\%$	1st I. F. Screen Filter	A-8B-516 SM or SS
49-4A		Capacitor	Paper 250 volts DC .5 mfd $\pm 15\%$	Battery Filter	A-8B-515 SM or SS
49-4B		Capacitor	Paper 250 volts DC .5 mfd $\pm 15\%$	Battery Filter	A-8B-515 SM or SS
55-1		Resistor	Insul. 470 ohms $\pm 10\%$ $\frac{1}{2}$ watt	1st R. F. Cathode	A-9B1-58 CRL
55-2		Resistor	Insul. 470 ohms $\pm 10\%$ $\frac{1}{2}$ watt	2nd R. F. Cathode	A-9B1-58 CRL
55-3		Resistor	Insul. 470 ohms $\pm 10\%$ $\frac{1}{2}$ watt	1st I. F. Cathode	A-9B1-58 CRL
55-4		Resistor	Insul. 470 ohms $\pm 10\%$ $\frac{1}{2}$ watt	2nd I. F. Cathode	A-9B1-58 CRL
56-1		Resistor	Insul. 1000 ohms $\pm 10\%$ $\frac{1}{2}$ watt	Osc. plate	A-9B1-62 CRL
56-2		Resistor	Insul. 1000 ohms $\pm 10\%$ $\frac{1}{2}$ watt	3rd I. F. Cathode	A-9B1-62 CRL
57-1		Resistor	Insul. 4700 ohms $\pm 10\%$ $\frac{1}{2}$ watt	1st R. F. Plate	A-9B1-70 CRL
57-2		Resistor	Insul. 4700 ohms $\pm 10\%$ $\frac{1}{2}$ watt	2nd R. F. Plate	A-9B1-70 CRL
57-3		Resistor	Insul. 4700 ohms $\pm 10\%$ $\frac{1}{2}$ watt	1st Det. Plate	A-9B1-70 CRL
57-4		Resistor	Insul. 4700 ohms $\pm 10\%$ $\frac{1}{2}$ watt	1st I. F. Screen	A-9B1-70 CRL
57-5		Resistor	Insul. 4700 ohms $\pm 10\%$ $\frac{1}{2}$ watt	1st I. F. Plate	A-9B1-70 CRL
57-6		Resistor	Insul. 4700 ohms $\pm 10\%$ $\frac{1}{2}$ watt	Bleeder	A-9B1-70 CRL
57-7		Resistor	Insul. 4700 ohms $\pm 10\%$ $\frac{1}{2}$ watt	3rd I. F. Cathode	A-9B1-70 CRL



**TABLE OF REPLACEABLE PARTS—Continued**  
**BC-348-H**

Refer- ence No.	Stock No.	Name of Part	Description	Function	Drawing No.
58-1		Resistor	Insul. 10,000 ohms ±10% ½ watt	1st R. F. Screen	A-9B1-74 CRL
58-2		Resistor	Insul. 10,000 ohms ±10% ½ watt	2nd R. F. Screen	A-9B1-74 CRL
58-3		Resistor	Insul. 10,000 ohms ±10% ½ watt	1st Det. Screen	A-9B1-74 CRL
58-4		Resistor	Insul. 10,000 ohms ±10% ½ watt	C. W. Osc. Bleeder	A-9B1-84 CRL
59		Resistor	Insul. 12,000 ohms ±10% ½ watt	Voltage Regulator Series	A-9B1-75 CRL
60		Resistor	Insul. 15,000 ohms ±10% ½ watt	1st Det. Cathode	A-9B1-76 CRL
61		Resistor	Insul. 56,000 ohms ±10% ½ watt	Output loading	A-9B1-83 CRL
62		Resistor	Insul. 68,000 ohms ±10% ½ watt	C. W. Osc. Plate	A-9B1-84 CRL
63-1		Resistor	Insul. 100,000 ohms ±10% ½ watt	1st R. F. Grid	A-9B1-86 CRL
63-2		Resistor	Insul. 100,000 ohms ±10% ½ watt	2nd R. F. Grid	A-9B1-86 CRL
63-3		Resistor	Insul. 100,000 ohms ±10% ½ watt	Osc. Grid	A-9B1-86 CRL
63-4		Resistor	Insul. 100,000 ohms ±10% ½ watt	Output Grid Filter	A-9B1-86 CRL
64		Resistor	Insul. 180,000 ohms ±10% ½ watt	3rd I. F. Screen	A-9B1-89 CRL
65-1		Resistor	Insul. 470,000 ohms ±10% ½ watt	Antenna protective	A-9B1-94 CRL
65-2		Resistor	Insul. 470,000 ohms ±10% ½ watt	1st I. F. Grid	A-9B1-94 CRL
65-3		Resistor	Insul. 470,000 ohms ±10% ½ watt	2nd I. F. Grid	A-9B1-94 CRL
65-4		Resistor	Insul. 470,000 ohms ±10% ½ watt	C. W. Osc. Grid	A-9B1-94 CRL
66		Resistor	Insul. 560,000 ohms ±10% ½ watt	Output Grid	A-9B1-95 CRL
67		Resistor	Insul. 1.5 megohms ±10% ½ watt	AVC Diode	A-9B1-100 CRL
68		Resistor	Insul. 220,000 ohms ±10% ½ watt	AVC filter	A-9B1-90 CRL
69		Resistor	Insul. 75 ohms ±10% ½ watt	Osc. Compensating	A-9B-726 CRL

**TABLE OF REPLACEABLE PARTS—Continued**  
**BC-348-H**

Reference No.	Stock No.	Name of Part	Description	Function	Drawing No.
70		Resistor	Insul. 47,000 ohms ±10% ½ watt	Bleeder	A-9B1-82 CRL
73		Resistor	Insul. 2400 ohms ±5% ½ watt	Output Plate	A-9B1-168 CRL
74		Resistor	Insul. 10,000 ohms ±10% 1 watt	Bleeder	A-9B2-74 CRL
75		Resistor	Insul. 27,000 ohms ±10% 1 watt	Voltage Regulator	A-9B2-79 CRL
76-A		Resistor	Insul. 3 ohms ±10% 1.5 watts	Filament	A-9D-519 IRC
76-B		Resistor	Insul. 190 ohms ±10% 1.9 watts	Filament	A-9D-519 IRC
77		Resistor	Insul. 60 ohms ±10% 3.7 watts	Lamp Series 60 ¼ A	A-9D-317 IRC
78		Resistor	Variable 3500 ± 10% to 10 ohms .1 watt	Noise Compensator	A-9A-714 IRC
79-A		Resistor	Volume Control Front Unit 20,000 ohms ±10% to 10 ohms .2 watt	M. V. C.	B-10A-295 AB
79-B		Resistor	Volume Control Back Unit 350,000 ohms ±10% to 50 ohms .2 watt	A. V. C.	B-10A-295 AB
80		Resistor	Variable 200 ohms ±10% 4 watts	Dial Lamp Control	A-9A-304 PRM
90		Inductance	Antenna Band 1	1st R. F. Tuned Circuit	B-204-107
91		Inductance	Antenna Band 2	1st R. F. Tuned Circuit	C-204-75-1
92		Inductance	Antenna Band 3	1st R. F. Tuned Circuit	C-204-75-4
93		Inductance	Antenna Band 4	1st R. F. Tuned Circuit	C-204-75-7
94		Inductance	Antenna Band 5	1st R. F. Tuned Circuit	C-204-75-10
95		Inductance	Antenna Band 6	1st R. F. Tuned Circuit	C-204-75-13
96		Inductance	R. F. Band 1	1st R. F. to 2nd R. F. Coupling	B-204-109
97		Inductance	1st Det. Band 1	2nd R. F. to 1st Det. Coupling	B-204-105

**TABLE OF REPLACEABLE PARTS—Continued**  
**BC-348-H**

<b>Refer- ence No.</b>	<b>Stock No.</b>	<b>Name of Part</b>	<b>Description</b>	<b>Function</b>	<b>Drawing No.</b>
98-1		Inductance	R. F. Band 1	Plate Load 1st R. F.	A-204-103
98-2		Inductance	Det. Band 1	Plate Load 2nd R. F.	A-204-103
100		Inductance	R. F. Choke	Power Supply Filter	A-17A-718
101		Transformer	R. F. Band 2	1st R. F. to 2nd R. F. Coupling	C-204-75-2
102		Transformer	R. F. Band 3	1st R. F. to 2nd R. F. Coupling	C-204-75-5
103		Transformer	R. F. Band 4	1st R. F. to 2nd R. F. Coupling	C-204-75-8
104		Transformer	R. F. Band 5	1st R. F. to 2nd R. F. Coupling	C-204-75-11
105		Transformer	R. F. Band 6	1st R. F. to 2nd R. F. Coupling	C-204-75-14
106		Transformer	1st Det. Band 2	2nd R. F. to Det. Coupling	C-204-75-3
107		Transformer	1st Det. Band 3	2nd R. F. to Det. Coupling	C-204-75-5
108		Transformer	1st Det. Band 4	2nd R. F. to Det. Coupling	C-204-75-9
109		Transformer	1st Det. Band 5	2nd R. F. to Det. Coupling	C-204-75-12
110		Transformer	1st Det. Band 6	2nd R. F. to Det. Coupling	C-204-75-15
111		Transformer	Osc. Band 1	Osc. to 1st Det. Coupling	C-204-65-1
112		Transformer	Osc. Band 2	Osc. to 1st Det. Coupling	C-204-65-2
113		Transformer	Osc. Band 3	Osc. to 1st Det. Coupling	C-204-65-3
114		Transformer	Osc. Band 4	Osc. to 1st Det. Coupling	C-204-65-4
115		Transformer	Osc. Band 5	Osc. to 1st Det. Coupling	C-204-65-5
116		Transformer	Osc. Band 6	Osc. to 1st Det. Coupling	C-204-65-6
117		Transformer	1st I. F.	1st Det. to Crystal Coupling	AR

**TABLE OF REPLACEABLE PARTS—Continued**  
**BC-348-H**

Reference No.	Stock No.	Name of Part	Description	Function	Drawing No.
118		Transformer	Crystal Filter	Crystal to 1st I. F. Coupling	AR
119		Transformer	2nd I. F.	1st I. F. to 2nd I. F. Coupling	AR
120		Transformer	3rd I. F.	2nd I. F. to 3rd I. F. Coupling	AR
121		Transformer	C. W. Osc.	Grid & Plate Coupling	AR
122		Transformer	4th I. F.	3rd I. F. to 2nd Det. Coupling	AR
123-A		Transformer	Audio	Output	D-206-17 CT
123-B		Choke	Audio Frequency	Filter	D-206-17 CT
123-C		Capacitor	Paper 400 volts DC .05 mfd $\pm 10\%$	C. W. Osc. Time Constant	D-206-17 CT
124-1		Jack	Single Circuit	Headphone	A-44A-300 PRM
124-2		Jack	Single Circuit	Headphone	A-44A-300 PRM
125		Regulator	Neon Bulb Type RCA 991	Osc. Plate Voltage regulator	RCA
126		Lamp	6 to 8 volts Type 44 (LM-27)	Dial Lights	A-46A-314 GE
127		Switch	SPST type	Crystal Filter (in-out)	A-20C-676 AH
128		Switch	DPST Type	C. W. Osc. (on-off)	A-20C-303 AH
129		Switch	2 position, 2 wafers type	AVC-off-MVC	B-20D-298 CRL or OM
130		Switch	6 position, 1 wafer	Band Switch Antenna Unit	B-20A-611 CRL or OM
131		Switch	6 position, 1 wafer	Band Switch Antenna Unit	B-20A-611 CRL or OM
132		Switch	6 position, 1 wafer	Band Switch R. F. Unit	B-20A-585 CRL or OM
133-A } 133-B }		Switch	6 position, 1 wafer	Band Switch R. F. Unit	B-20A-585 CRL or OM
134		Switch	6 position, 1 wafer	Band Switch Det. Unit	B-20A-585 CRL or OM
135-A } 135-B }		Switch	6 position, 1 wafer	Band Switch Det. Unit	B-20A-585 CRL or OM

**TABLE OF REPLACEABLE PARTS—Continued**  
**BC-348-H**

Reference No.	Stock No.	Name of Part	Description	Function	Drawing No.
136		Switch	6 position, 1 wafer	Band Switch Osc. Unit	B-20A-537 CRL or OM
137		Switch	6 position, 1 wafer	Band Switch Osc. Unit	B-20A-537 CRL or OM
138		Switch	6 position, 1 wafer	Band Switch Osc. Unit	B-20A-537 CRL or OM
139		Switch	6 position, 1 wafer	Band Switch Osc. Unit	B-20A-537 CRL or OM
140		Fuse	5 amp. 25 volt type FU-35	Primary Protective	A-46B-315 LL
141		Crystal Assembly	915 Kc Crystal mounted in Case	I. F. Filter	A-8K-690 BE
142		Binding Post	Panel	Antenna Connection	A-201-26 ARH
143		Binding Post	Panel	Ground Connection	A-7C-296 ARH
201		Handle	Panel	Carrying	A-23A-301 NL
202		Lever	Control	AVC-OFF-MVC	A-4B-262
203		Knob	Control	Antenna alignment Cond. Crystal switch, Dial Lamp control, and vol- ume control	A-4B-247
204		Knob	Control	C. W. Osc. Freq. Control	A-4B-249
205		Thumb Screws	Dial Window	Holds Dial Window	A-3F-291
206		Knob	Control	Band Change	A-4B-261
207		Knob	Control	Main Tuning Cond.	B-4B-260
208		Cover	Panel	Permits Access to Tube Shelf	A-2E-550
209		Special Screw	Shouldered	Main tuning Cond.	A-3F-629
210		Special Screw	Shouldered Flathead	Dynamotor Assem. to Mounting Plate	A-3F-378
211		Special Screw	Captive	Dynamotor Assembly	A-3F-369
212		Special Screw	Slotted Hex Head	Dial Assembly to Chassis	A-3F-321

**TABLE OF REPLACEABLE PARTS—Continued**  
**BC-348-H**

Reference No.	Stock No.	Name of Part	Description	Function	Drawing No.
213		Special Screw	Shouldered	Secures Plug to Mounting Plate	A-3F-258
214		Cover	Plate with captive	Covers Tube in Osc. Unit	A-202-72
215		Shield	Tube, Special	Shield for Tube VT 70	B-202-97
216		Fuse Clip Assembly	Laminated Phenolic Strip with Fuse Clips	Power Fuse	A-26D-632 LL
217		Socket	Tube Octal Type	For Tubes VT86 and VT152 VT91 and VT65 VT93	A-15C-521 NF
218		Socket	Bayonet Type, Special	For Voltage Regulator Tube	A-27A-528 CH
219		Socket	Tube, 7 Prong	For Tube VT 70	A-15C-639 NF
221		Socket	Lamp	For Dial Lamp	A-47A-402 DM
222		Fitting	8 Pole, male (SO-104)	Power Connections	A-201-33
251		1st I. F. Transformer Assembly	Complete with Shield Can. Includes 32, 33, 39 and 117	1st Det. to 1st I. F. Coupling	B-13A-679 AR
252		2nd I. F. Transformer Assembly	Complete with Shield Can. Includes 35-1, 35-2 and 119	1st I. F. to 2nd I. F. Coupling	B-13H-681 AR
253		3rd I. F. Transformer Assembly	Complete with Shield Can. Includes 34-2, 34-3 and 120	2nd I. F. to 3rd I. F. Coupling	B-13H-682 AR
254		4th I. F. Transformer Assembly	Complete with Shield Can. Includes 36, 37-1 and 122	3rd I. F. to 2nd Det. Coupling	B-13B-680 AR
255		Crystal Filter Assembly	Complete with Shield Can. Includes 8, 34-1, 118, 127 and 141.	I. F. Selectivity	B-13J-685 AR
256		C. W. Osc. Assembly	Complete with Shield Can. Includes 9, 11-12, 35-3, 37-2, 62 and 121.	C. W. Reception	B-13D-683 AR

**TABLE OF REPLACEABLE PARTS—Continued**  
**BC-348-H**

Reference No.	Stock No.	Name of Part	Description	Function	Drawing No.
257		Antenna Unit Assembly	Complete with Shield Can. Includes 2, 3-1, 3-2, 4-1, 5-1, 5-2, 12-1, 12-2, 15, 21-1, 22-1, 24, 25, 63-1, 72, 90, 96, 92, 93, 94, 95, 130 and 131.	Ant. to 1st R. F. Tube Coupling	C-204-13 AR
258		R. F. Unit Assembly	Complete with Shield Can. Includes 3-3, 3-4, 4-2, 5-3, 5-4, 7-1, 12-3, 13-1, 13-2, 21-2, 22-2, 23-2, 23-3, 26-1, 27-1, 29-1, 30-1, 57-1, 63-2, 91, 96, 98-1, 101, 102, 103, 104, 105, 132 and 133.	1st R. F. to 2nd R. F. Tube Coupling	C-204-15
259		Det. Unit Assembly	Complete with Shield Can. Includes 3-5, 3-6, 4-3, 5-5, 5-6, 7-2, 12-4, 21-3, 22-3, 23-1, 23-4, 26-2, 29-2, 27-2, 30-2, 57-2, 97, 98-2, 106, 107, 108, 109, 110, 134, and 135.	2nd R. F. to 1st Det. Tube Coupling	C-204-14
260		Osc. Unit Assembly	Complete with Shield Can. Includes 3-7, 3-8, 6-1, 6-2, 6-3, 6-4, 10, 14-1, 14-2, 17-1, 17-2, 18, 19, 20, 28, 40, 41, 42, 43, 44, 45, 46, 47, 56-1, 60, 63-3, 69, 111, 112, 113, 114, 115, 116, 136, 137, 138, 139, 214 and 217.	Heterodyne Osc. to 1st Det. Coupling	C-204-16
271		Resistor Board	17 Terminal	Supports Parts 16, 57-6, 59, 63-4, 74 and 75.	B-201 58
272		Resistor Board	32 Terminal	Supports Parts 11-13, 11-14, 11-15, 11-16, 11-18, 31-1, 31-2, 57-7, 56-2, 61, 64, 66, and 73.	B-201-60
273		Resistor Board	14 Terminal	Supports Parts 11-9, 11-10, 11-11, 55-4, 57-4, 57-5, and 65-3.	B 201-20
274		Resistor Board	14 Terminal	Supports Parts 11-6, 11-7, 57-3, 58-4, 65-2 and 70.	B-201-36

**TABLE OF REPLACEABLE PARTS—Continued**  
**BC-348-H**

Reference No.	Stock No.	Name of Part	Description	Function	Drawing No.
276		Dial Mechanism	Complete with Mask, Index Gear Drive, Stop and Detent Mechanism	Frequency Indicator Tuning Condenser Drive	D-200-18
300		Dynamotor	27.9 volts, 1.23 Amp; 220 volts .070 amp. 4400 R.P.M. DM-28-M	Motor Generator	A-21C-348 E or WC
301		Choke	RF	Dynamotor Filter	B-207-41
302		Choke	RF	Dynamotor Filter	A-207-42 RM
303-A		Capacitor	Paper 250 volts DC .5 mfd. $\pm 20\%$	Dynamotor Filter	A-8B-383 JF
303-B		Capacitor	Paper 250 volts DC .5 mfd. $\pm 20\%$	Dynamotor Filter	A-8B-383 JF
304		Capacitor	Paper 400 volts DC 1.0 mfd $\pm 20\%$	Dynamotor Filter	A-8B-361 JF
305-1		Capacitor	Mica 500 volts DC .01 mfd $\pm 10\%$	Dynamotor Filter	B-8F-363 CD or SM
305-2		Capacitor	Mica 500 volts DC .01 mfd $\pm 10\%$	Dynamotor Filter	B-8F-363 CD or SM
306		Armature	Part of Ref. 300	Dynamotor	A-55A-814 E or WC
307		Bearing (Set of 2)	Part of Ref. 300	Dynamotor	A-55A-815 E or WC
308		Brush & Spring	Part of Ref. 300	Pos. H.V.	A-55A-772 E or WC
309		Brush & Spring	Part of Ref. 300	Neg. H.V.	A-55A-773 E or WC
310		Brush & Spring	Part of Ref. 300	Pos. L.V.	A-55A-770 E or WC
311		Brush & Spring	Part of Ref. 300	Neg. L.V.	A-55A-771 E or WC
315		End Bell	Part of Ref. 300	Low Voltage End Bearing	A-4A-835 E or WC
316		End Bell	Part of Ref. 300	High Voltage End Bearing	A-4A-836 E or WC
{ 317 318		Field Windings	Part of Ref. 300. Field Windings (available in pairs only)	Dynamotor	A-16B-837 E or WC



**TABLE OF REPLACEABLE PARTS—Continued**  
**BC-348-H**

Reference No.	Stock No.	Name of Part	Description	Function	Drawing No.
319		Tie Bars	Part of Ref. 300	Holds Items 315 and 316 to frame	A-3F-838 E or WC
320		Brush Caps	Part of Ref. 300	Holds Brushes	A-5B-839 E or WC
321		Grommet	Part of Ref. 300	Protects Terminal Wires	A-41B-840 E or WC
322		Gasket	Part of Ref. 300	Prevents Leakage of Lubricant	A-41A-841 E or WC
323		Plate	Part of Ref. 300	Bearing Retainer	A-2E-842 E or WC
324		Cover	Part of Ref. 300	Dust Cover	A-2E-843 E or WC
350		Bracket & Gear & Assembly	Pair of Beveled Gears & Coupling	Drives Band Change Switch	A-200-22
351		Coupling	Flanged Collar with Rectangular Slot	Coupling Band Change Knob Shaft to Item 350	A-3E-480
352		Coupling Slide	Disk with two Rectangular Keys	Slide Between 2 or Item 351	A-3E-288
353		Window Frame Assembly	Removable Cast Housing Which Holds Dial Crystal	Covers Dial Lamps	B-200-24
355		Friction Spreader	Phosphorus Bronze Spring	Prevents Controls from turning under vibration	A-2J-404
356		Jack Cover Assembly	Spring Actuated Cover	Seals Jack Openings	A-23A-636 CN
357		Bushing	Threaded Bushing	Holds Handle to Panel and Provides Bearing for Thumb Screw	A-3B-302
358		Nut	Special Locking Nut	Holds Item 357	A-3G-625
359		Thumb Screw Assembly	No. 10-24 x 9 $\frac{9}{32}$ Long (Less Knob)	Holds Chassis in Cabinet	A-202-28
360		Nut	Special Locking Nut	Holds Upper End of Handles	A-3G-626
361		Flexible Shaft and Coupling	5 $\frac{1}{2}$ Inches Long, Including Couplings, Special	Operates B.F.O. Control	A-200-29
362		Extension Shaft	Special Shaft 0.594 Inches Long	Operates Crystal "On-Off" Switch	A-3A-305

**TABLE OF REPLACEABLE PARTS—Continued**  
**BC-348-H**

Reference No.	Stock No.	Name of Part	Description	Function	Drawing No.
363		Shaft & Coupling Assembly	Flexible Shaft with Insulated Coupling	Operates Antenna Trimmer	A-200-31
364		Switch Shaft	Flat Shaft	Operates Band Switch	A-2L-310
366		Dial Mask Assembly	Plate with Cutouts	Mask Undesired Dial Scales	B-200-44
367		Dial Assembly	Calibrated Circular Dial with Hub and Large Spur Gear	Gives Frequency Setting	B-200-45
368		Stop Arm Assembly	Lever with Roller and Pawl	Stops Condenser at End of Travel	A-200-46
369		Index Plate	Phosphorus Bronze Strip Painted Red	Dial Scale Index	A-2G-432
370		Stop	Cast Bushing With Key	Stops Stop Arm	A-4C-433
371		Stud	Shouldered Stud Threaded No. 4-40 One End	Pivot Pin for Part 368	A-3C-434
372		Guide Assembly	Arm and Roller Assembly	Engages Index Wheel for Switch Location	A-200-48
373		Spring	Coiled Spring	Operation of Indexing Arm Item 372	A-49A-442
374		Gear & Pinion Assembly	Spur Gear and Pinion Assembly	Idler Reduction Gear Between Tuning Shaft and Dial	A-200-50
375		Pinion	Pinion (Pinned to Tuning Shaft)	Dial Drive Pinion Meshing with Item 374	A-3J-450
376		Worm	Worm, Single Pitch	Drives Cross Shaft of Condenser Drive	A-3L-456
377		Gear Assembly	Split Worm Wheel	Part of Condenser Drive Train	A-200-51
378		Pinion and Bushing Assembly	Pinion on Cross Shaft	Drives Tuning Condenser Gear	A-200-54
379		Spring	Torsion Spring	Holds Item 368	A-49A-460
380		"C" Washer	"C" Washer	Against Dial used to Retain Items 372 and 374	A-29C-474

**TABLE OF REPLACEABLE PARTS—Continued**  
**BC-348-H**

Reference No.	Stock No.	Name of Part	Description	Function	Drawing No.
399		FT-154-H	Mounting Base Assembly	Supports Receiver	B-202-6
400		Mounting Plate Assembly	Part of Reference 399	Supports Item 401	B-202-7
401		Base and Stiffener Assembly	Part of Reference 399	Supports Receiver and Plug—Item 403 or 404	5-202-8
402		Cap Screw	1/4—20 x 1 1/16 Long	Holds Items 400 and 401 Together	B-3F-278
403		Fitting	8 Pole Female Power Connector PL-P103	Makes connection to Exterior Equipment	SC-D-2131B SC-D-2129B
404		Fitting	8 Pole Female Power Connector PL-Q103	Makes connection to Exterior Equipment	SC-D-2128B SC-D-2129B
405		Jack Block	Part of Reference 403 & 404 Numbered 1 & 5	Holds Contactors	B-5F-391-1
406		Jack Block	Part of Reference 403 & 404 numbered 2 & 6	Holds Contactors	B-5F-391-2
407		Jack Block	Part of Reference 403 & 404 numbered 3 & 7	Holds Contactors	B-5F-391-3
408		Jack Block	Part of Reference 403 & 404 numbered 4 & 8	Holds Contactors	B-5F-391-4
409		Jack Housing Assembly	Part of Reference 403 & 404	Houses Jack Blocks	B-202-2
410		Fitting (Right angle)	Part of Reference 404	Cable Protection and Shielding	B-4E-245
411		Fitting (straight)	Part of Reference 403	Cable Protection and Shielding	B-4E-533
412		Contact Spring Assembly	Part of Reference 403 & 404	Contact	A-201-5
413		Jack Housing Cover	Part of Reference 403 & 404	Covers Jack Block Terminals	A-202-3
414		Cover	Part of Reference 257	Top	A-2E-574

**TABLE OF REPLACEABLE PARTS—Continued**  
**BC-348-H**

Reference No.	Stock No.	Name of Part	Description	Function	Drawing No.
415		Cover	Part of Reference 257	Bottom	A-2E-575
416		Shield	Part of Reference 257	Side & Ends	C-2H-608
417		Cover	Part of Reference 258	Top	A-2E-573
418		Cover	Part of Reference 258	Bottom	A-2E-575
419		Shield	Part of Reference 258	Side & Ends	C-2H-568-1
420		Cover	Part of Reference 259	Top	A-2E-573
421		Cover	Part of Reference 259	Bottom	A-2E-575
422		Shield	Part of Reference 259	Side & Ends	C-2H-568-2
423		Cover	Part of Reference 260	Top	A-2E-549
424		Cover	Part of Reference 260	Bottom	A-2E-547
425		Cover	Part of Reference 260	Side	C-202-71
426		Shield	Part of Reference 260	Side & Ends	C-2H-534
433		Tube Guide	Cylindrical Socket for Tube Base	Supports Tube & Tube Shield VT 70	A-202-98
435		Shield Can.	Part of Reference 251	1st I.F. Transformer Assembly Shield	A-208-125 AR
436		Shield Can.	Part of Reference 252	2nd I.F. Transformer Assembly Shield	A-208-126 AR
437		Shield Can.	Part of Reference 253	3rd I.F. Transformer Assembly Shield	A-208-126 AR
438		Shield Can.	Part of Reference 254	4th I.F. Transformer Assembly Shield	A-208-125 AR
439		Shield Can.	Part of Reference 255	Crystal Filter Assembly Shield	A-208-128 AR
440		Shield Can.	Part of Reference 256	C. W. Osc. Assembly	A-208-127 AR

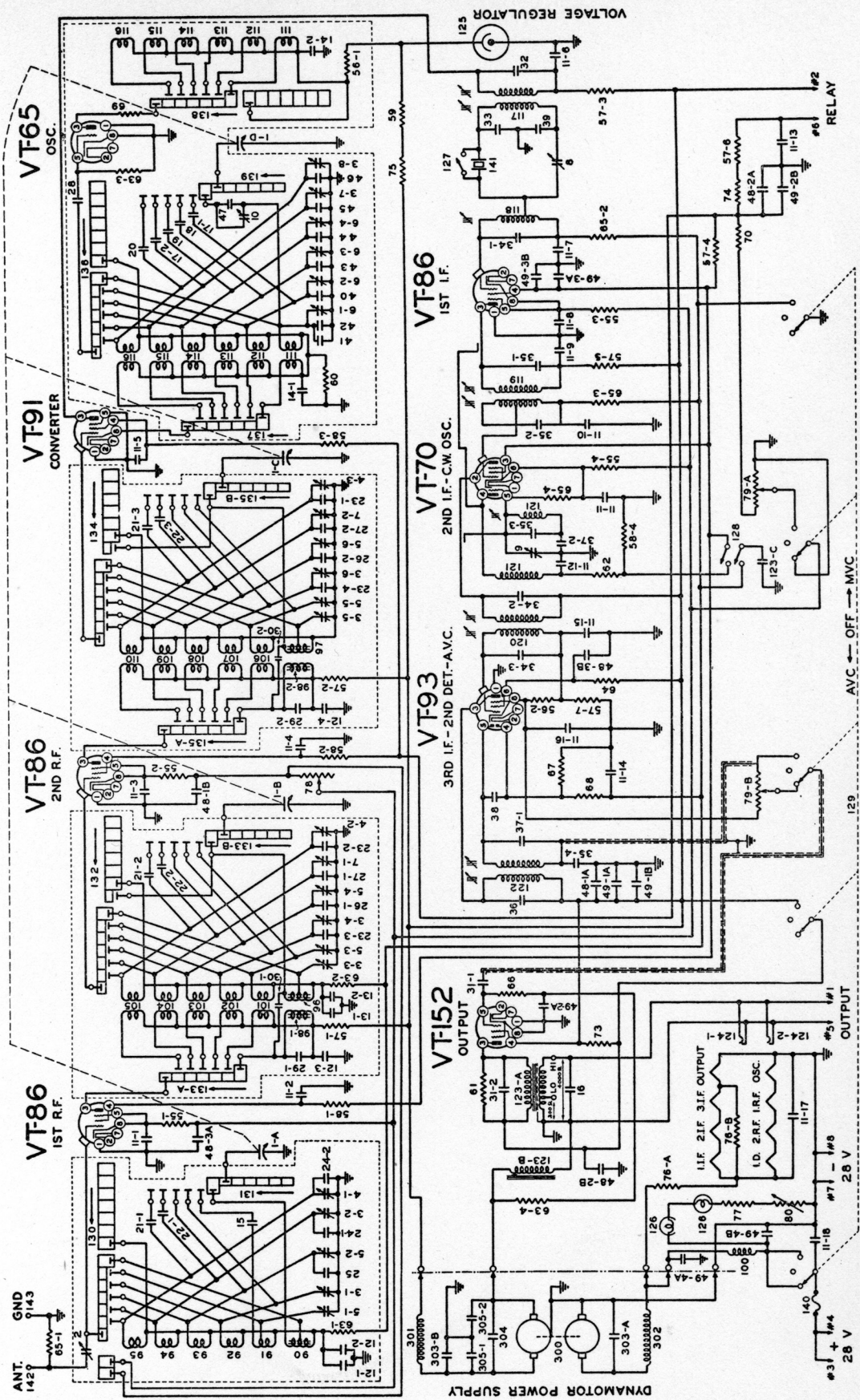

FIGURE 23—RADIO RECEIVER BC-348-H:  
SCHEMATIC CIRCUIT DIAGRAM

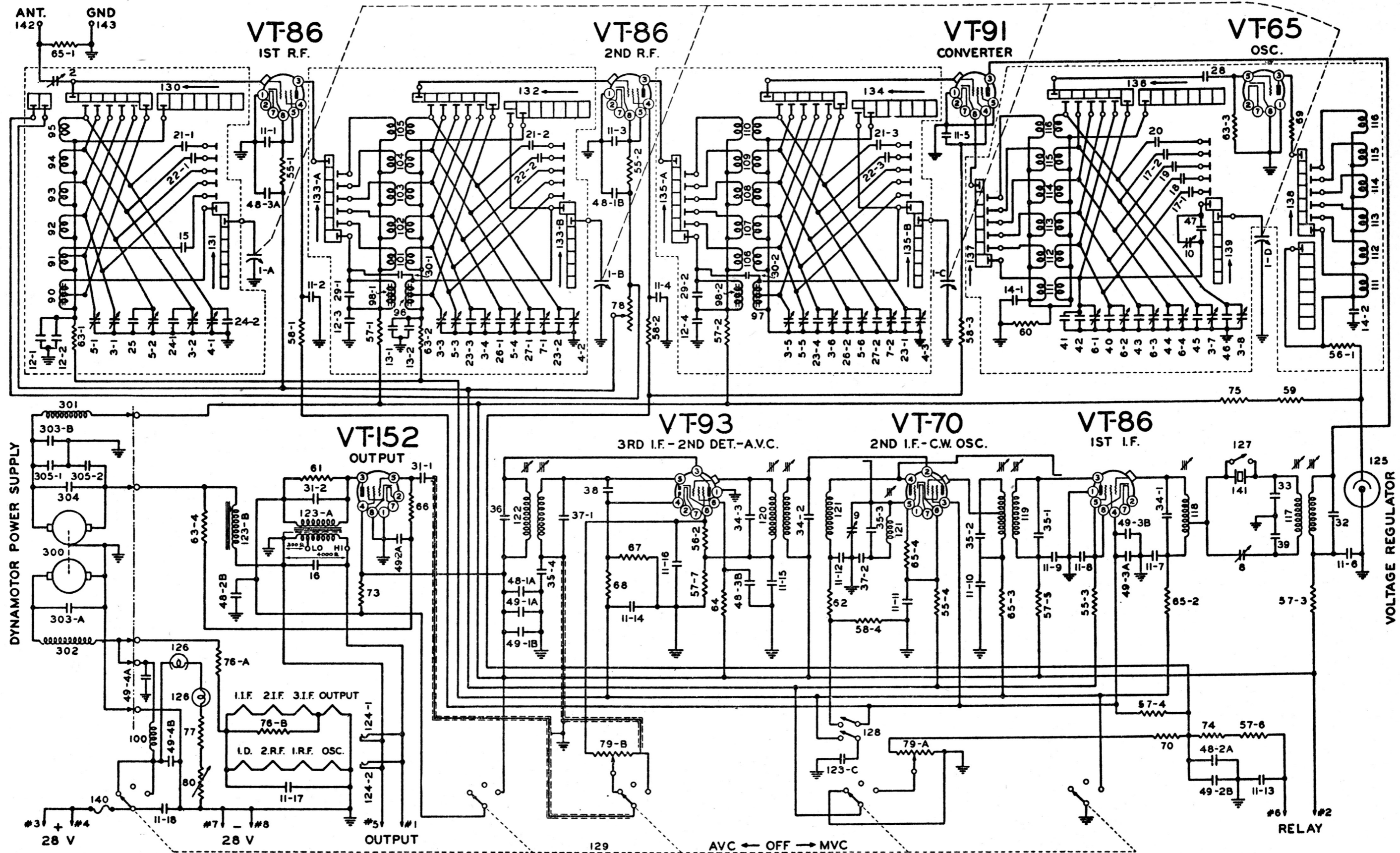

FIGURE 23—RADIO RECEIVER BC-348-H:  
SCHEMATIC CIRCUIT DIAGRAM

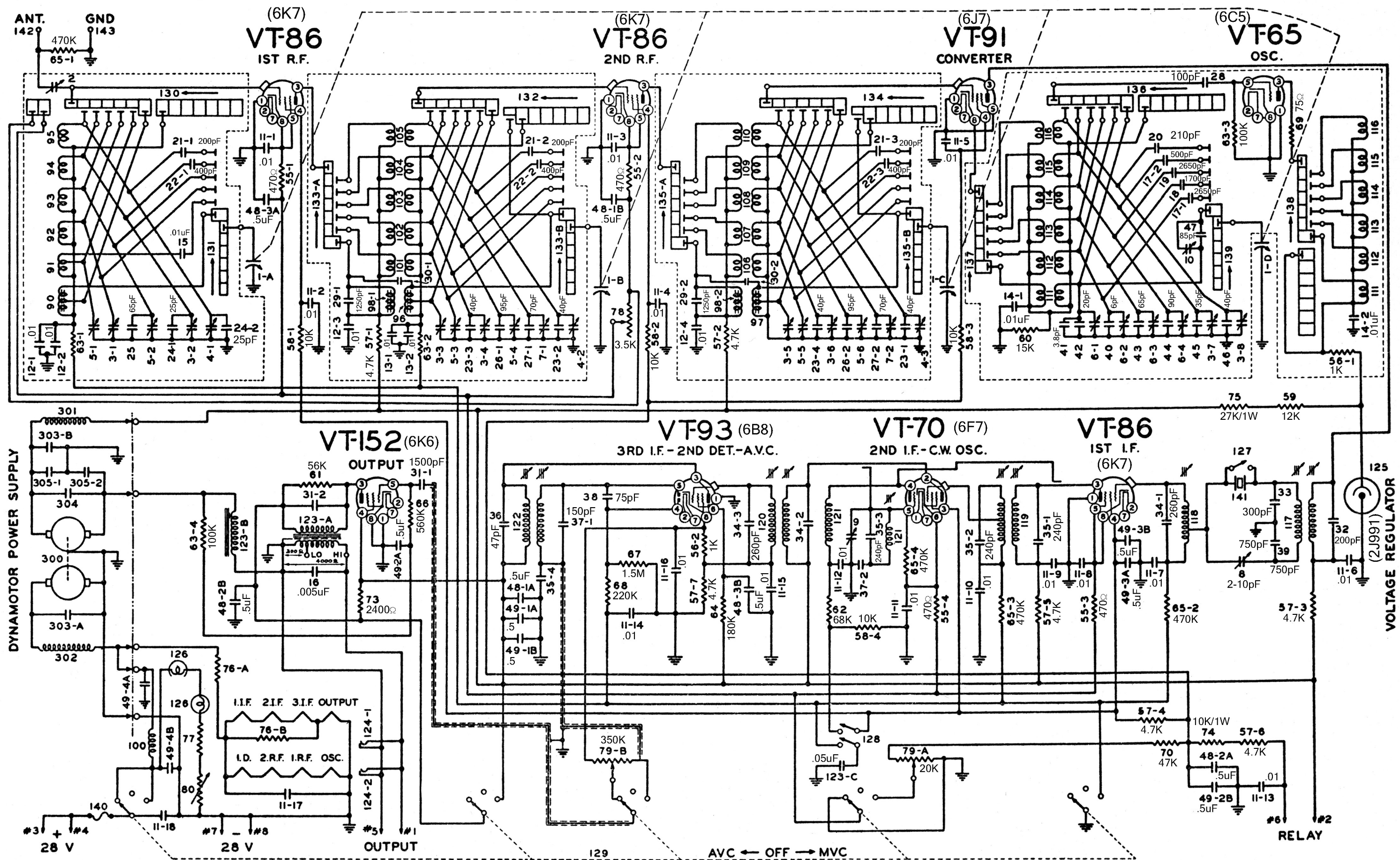
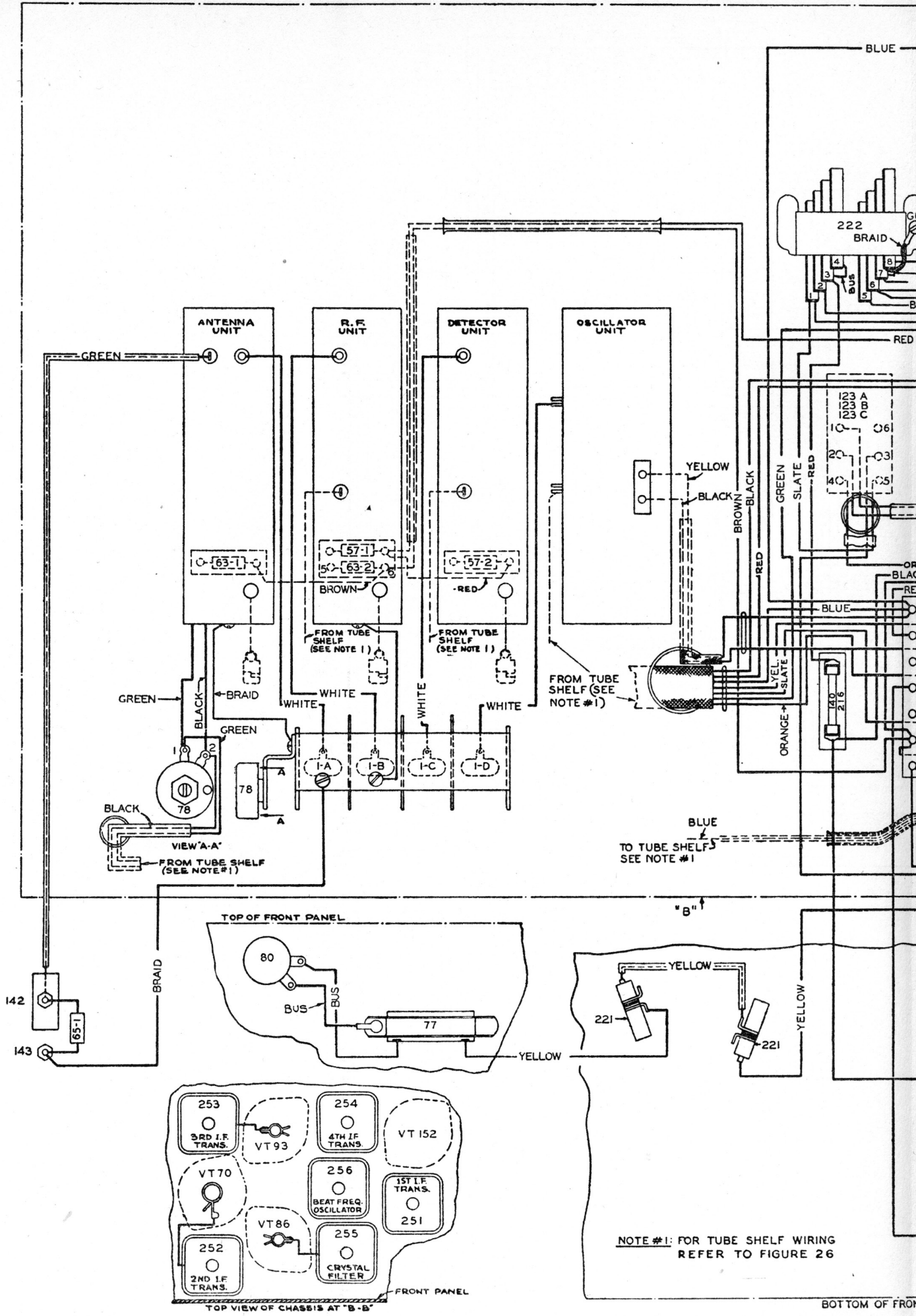

FIGURE 23—RADIO RECEIVER BC-348-H:  
SCHEMATIC CIRCUIT DIAGRAM



NOTE #1: FOR TUBE SHELF WIRING REFER TO FIGURE 26

BOTTOM OF FRONT PANEL



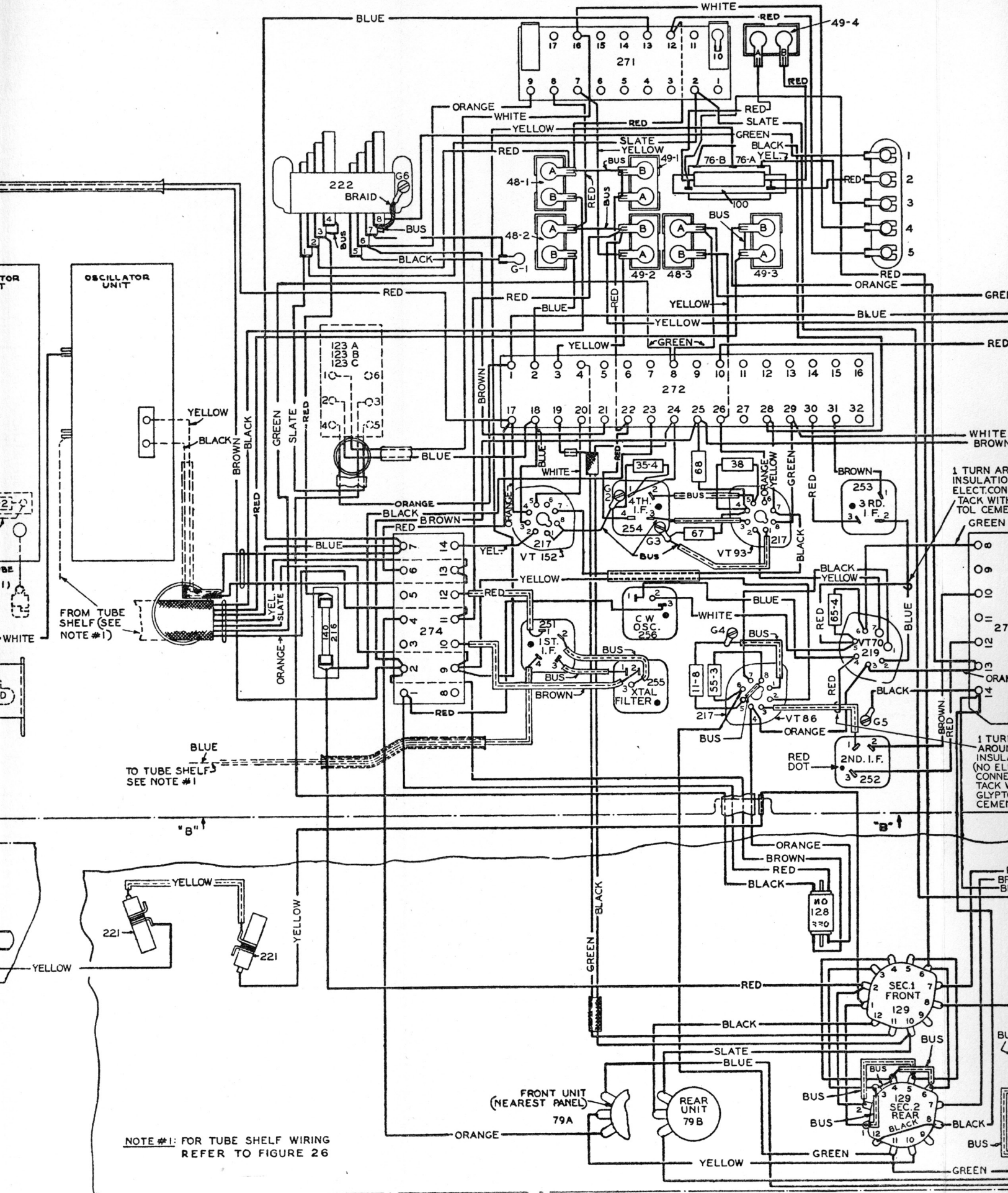

**OSCILLATOR UNIT**

FROM TUBE SHELF (SEE NOTE #1)

TO TUBE SHELF (SEE NOTE #1)

**NOTE #1:** FOR TUBE SHELF WIRING REFER TO FIGURE 26

BOTTOM OF FRONT PANEL

**FRONT UNIT (NEAREST PANEL)**  
79A

**REAR UNIT**  
79B

**SEC. 1 FRONT**  
129

**SEC. 2 REAR**  
129

1 TURN AROUND INSULATION ELECT. CON TACK WITH TOL CEMENT GREEN

1 TURN AROUND INSULATION (NO ELECT. CONN) TACK WITH GLYPH TOL CEMENT

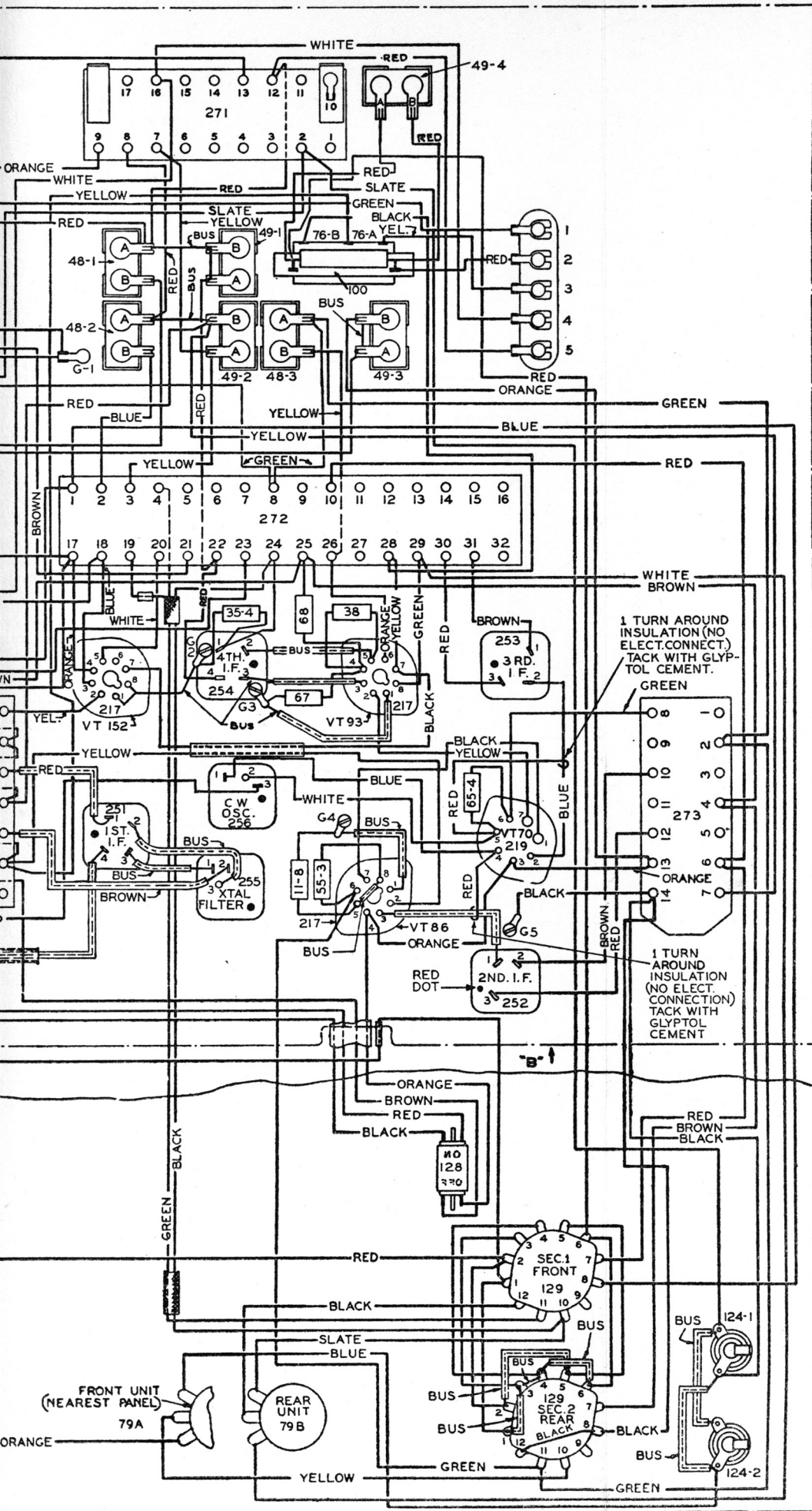

FIGURE 24—RADIO RECEIVER BC-348-H:  
WIRING DIAGRAM

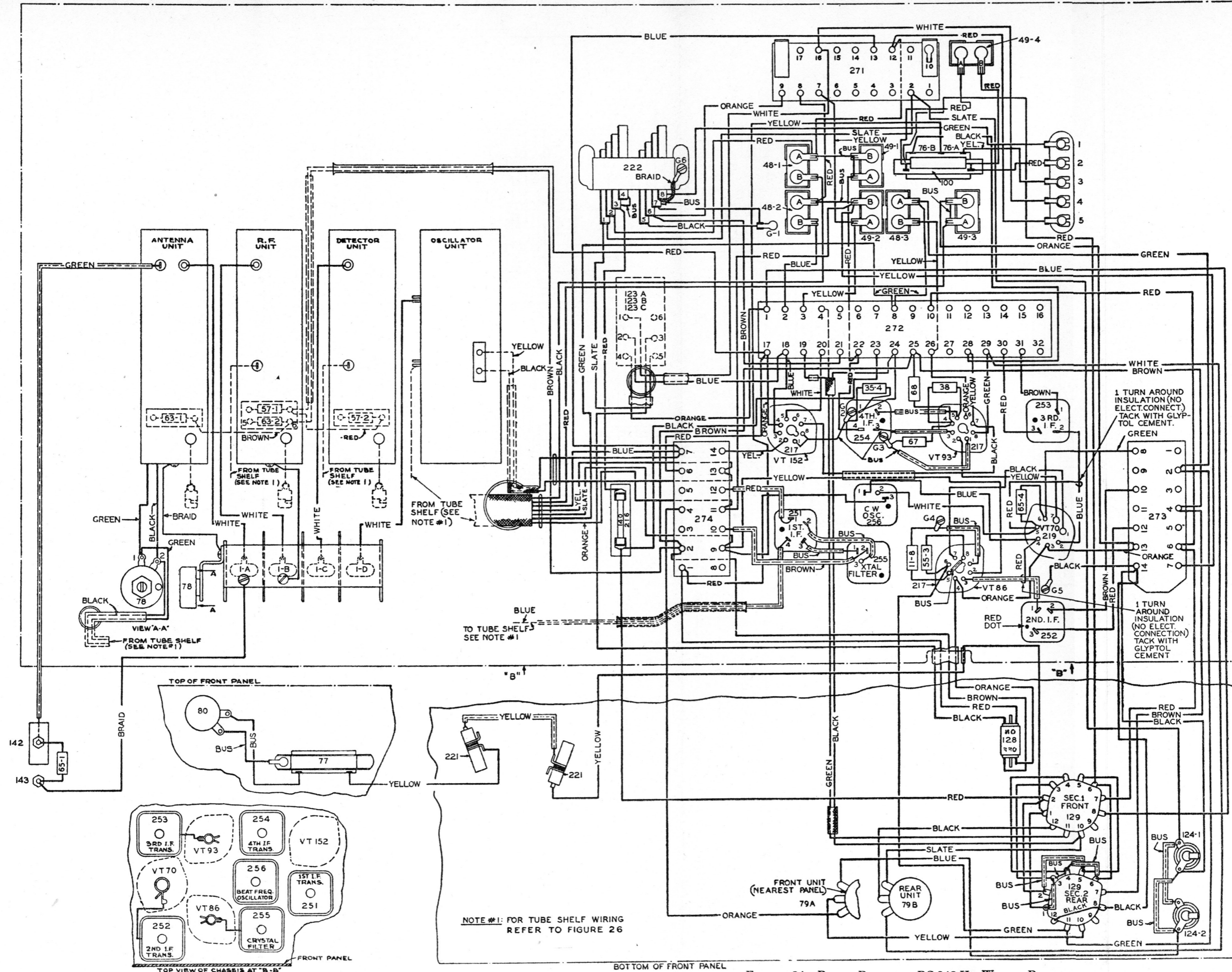

FIGURE 24—RADIO RECEIVER BC-348-H: WIRING DIAGRAM

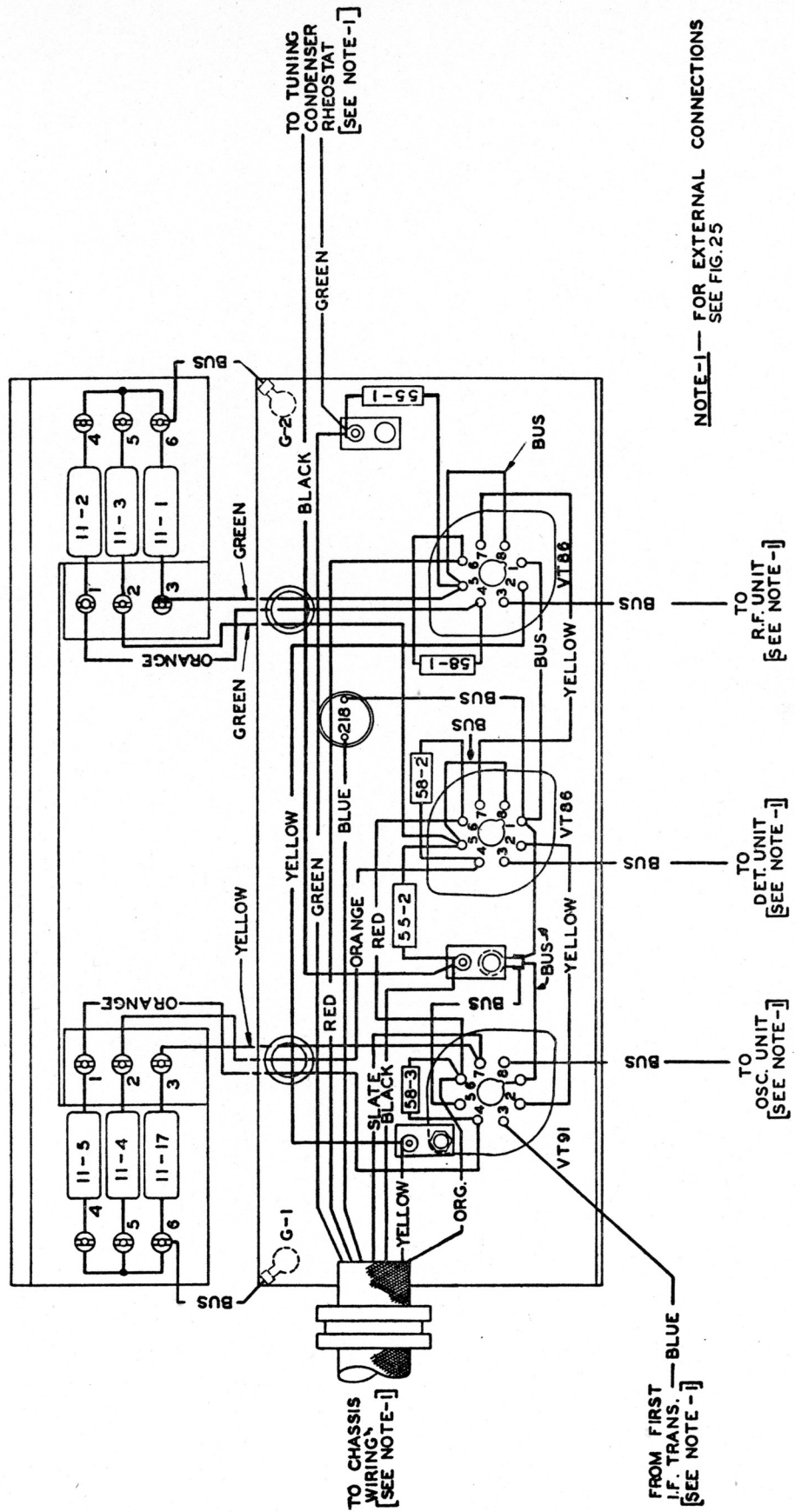

FIGURE 25—RADIO RECEIVER BC-348-H: WIRING DIAGRAM, TUBE SHELF

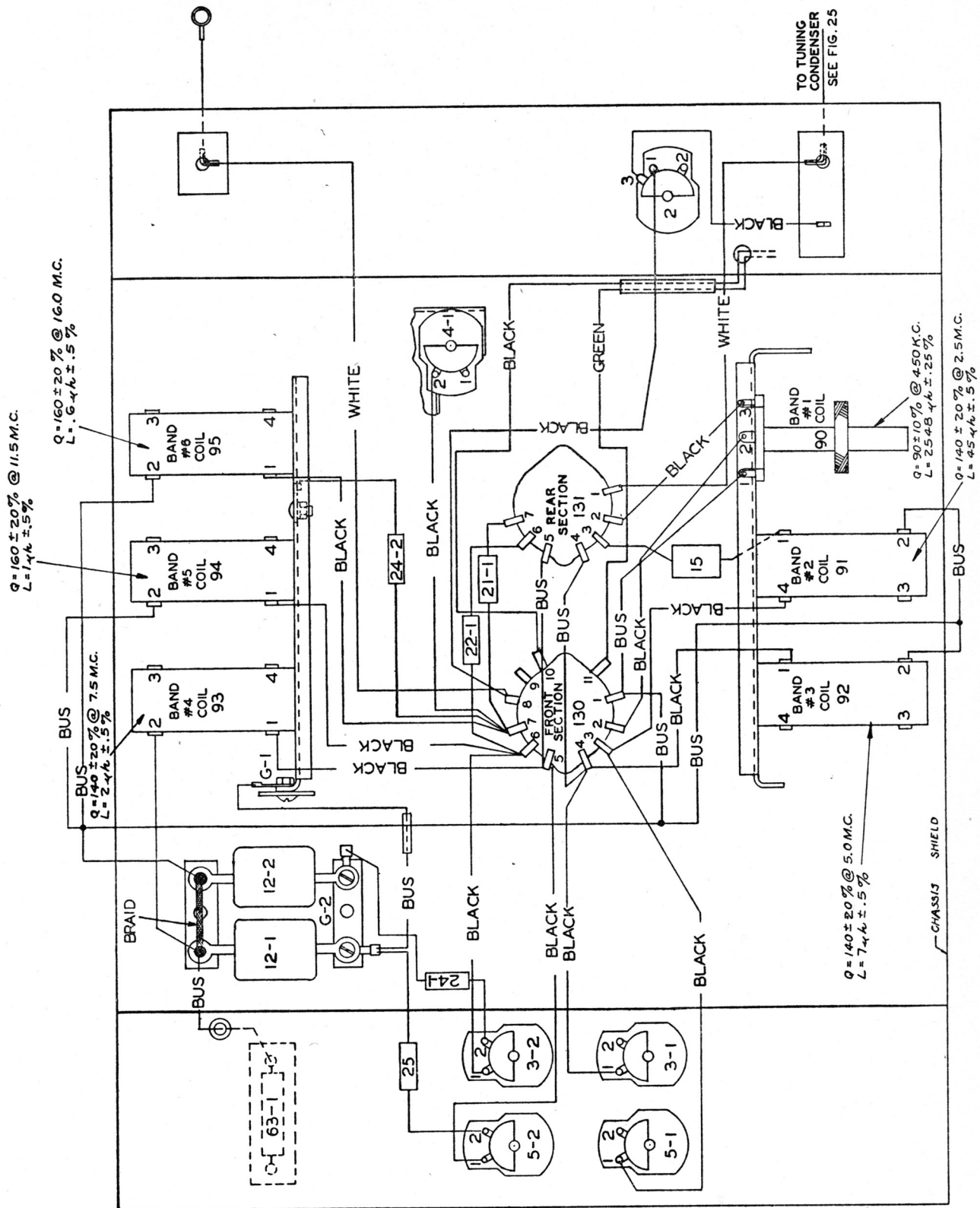

FIGURE 26—RADIO RECEIVER BC-348-H:  
WIRING DIAGRAM, ANTENNA UNIT

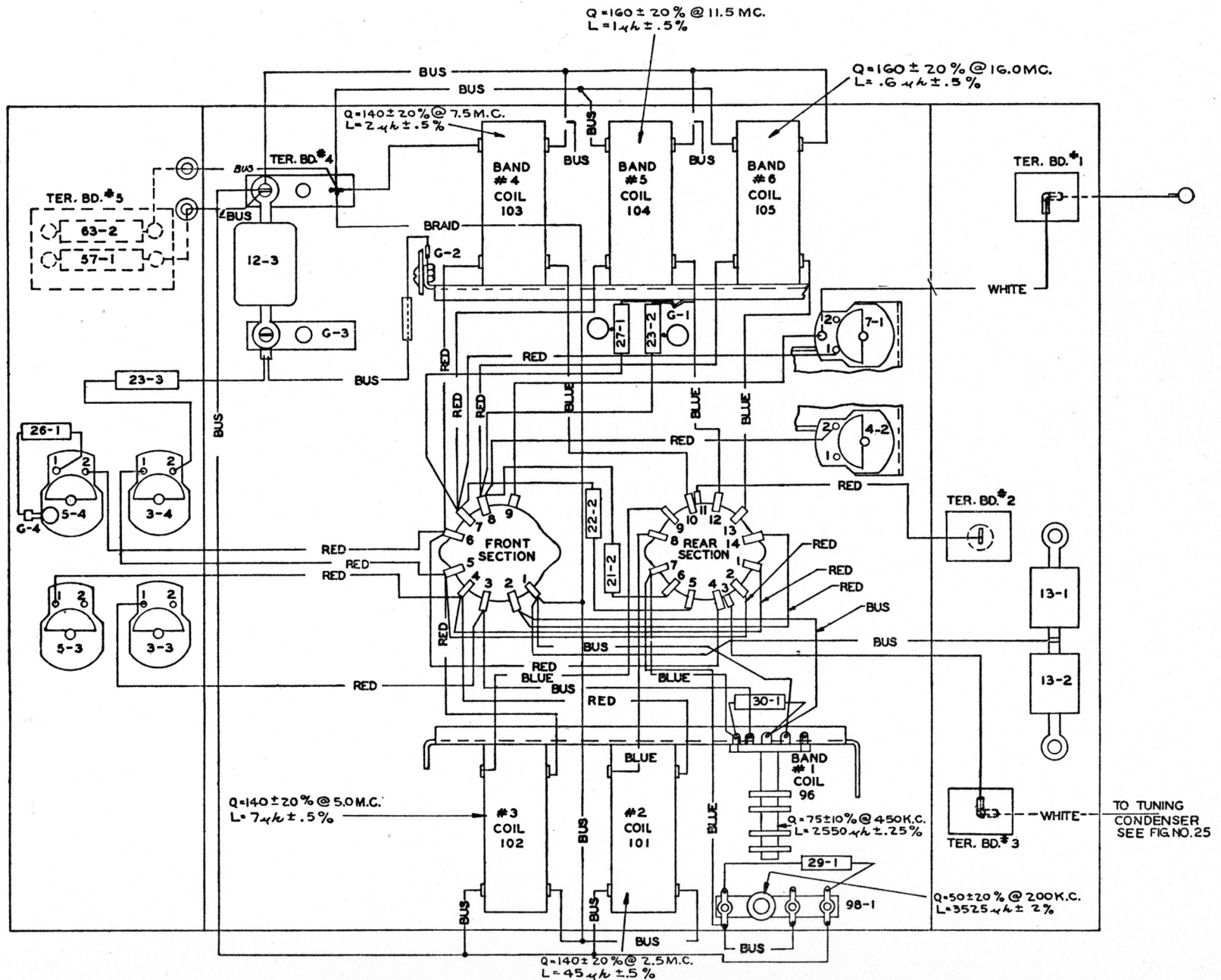

FIGURE 27—RADIO RECEIVER BC-348-H:  
WIRING DIAGRAM, R-F UNIT

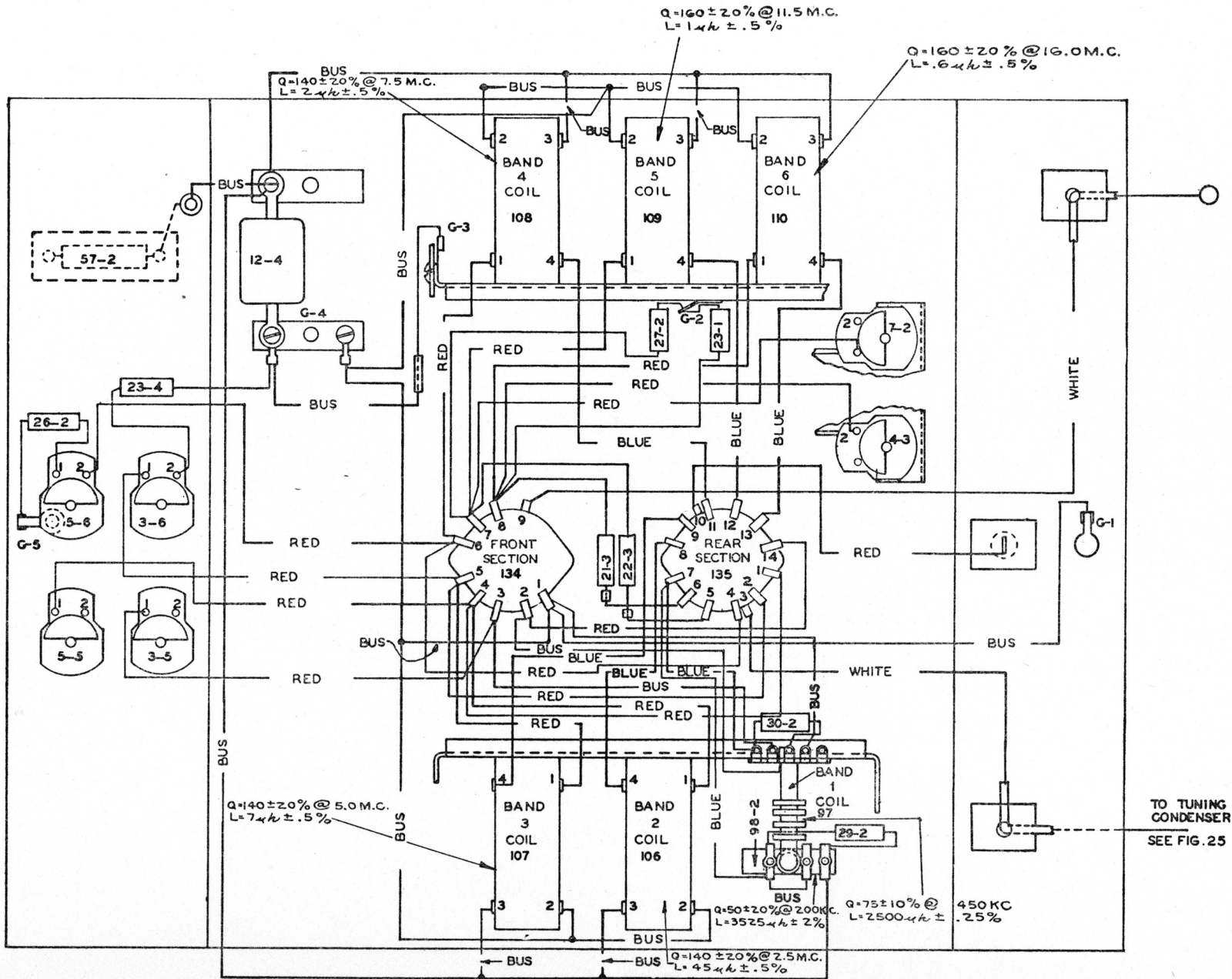

FIGURE 28—RADIO RECEIVER BC-348-H:  
WIRING DIAGRAM, DETECTOR UNIT

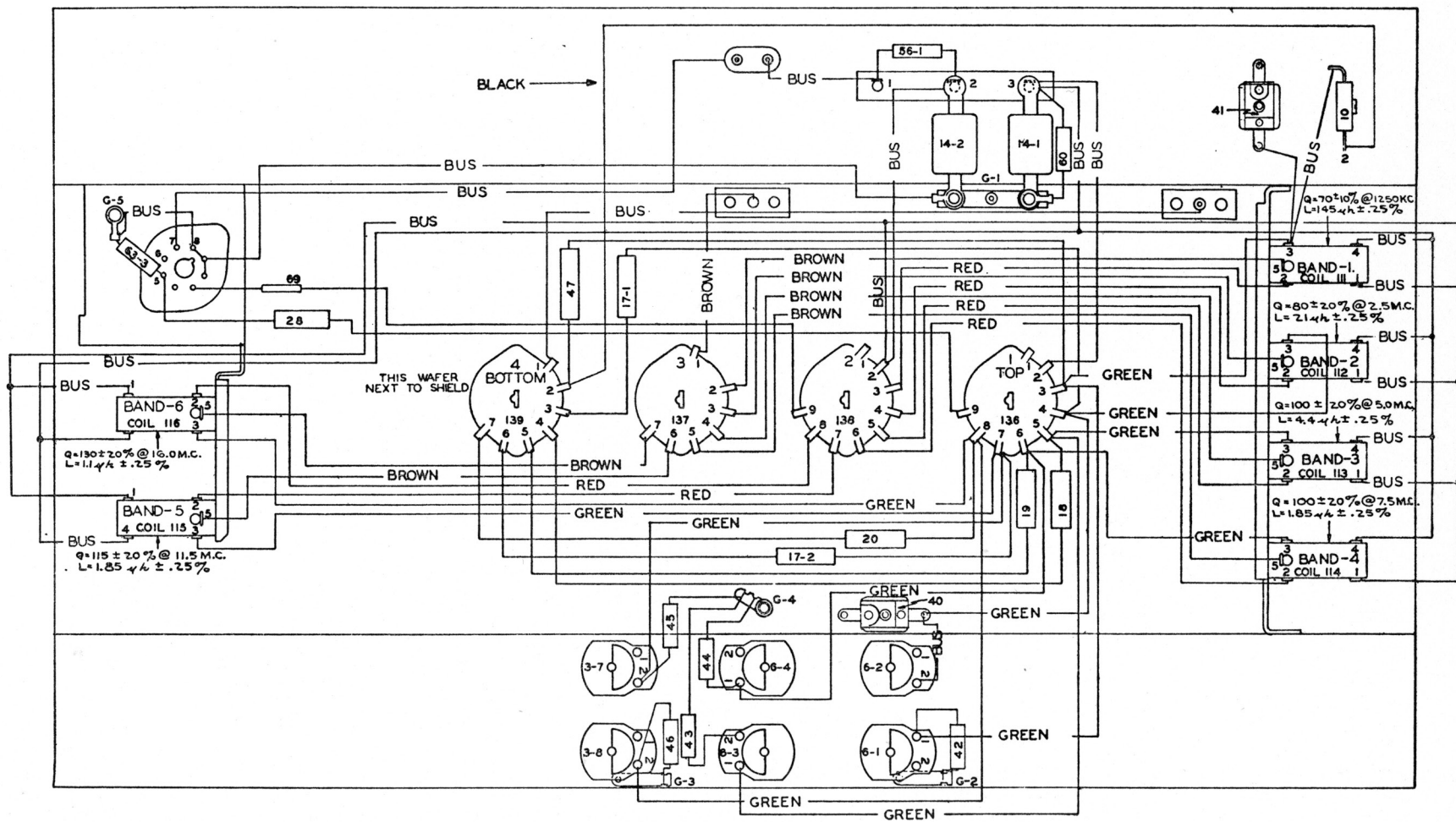

FIGURE 29—RADIO RECEIVER BC-348-H:  
WIRING DIAGRAM, OSCILLATOR UNIT



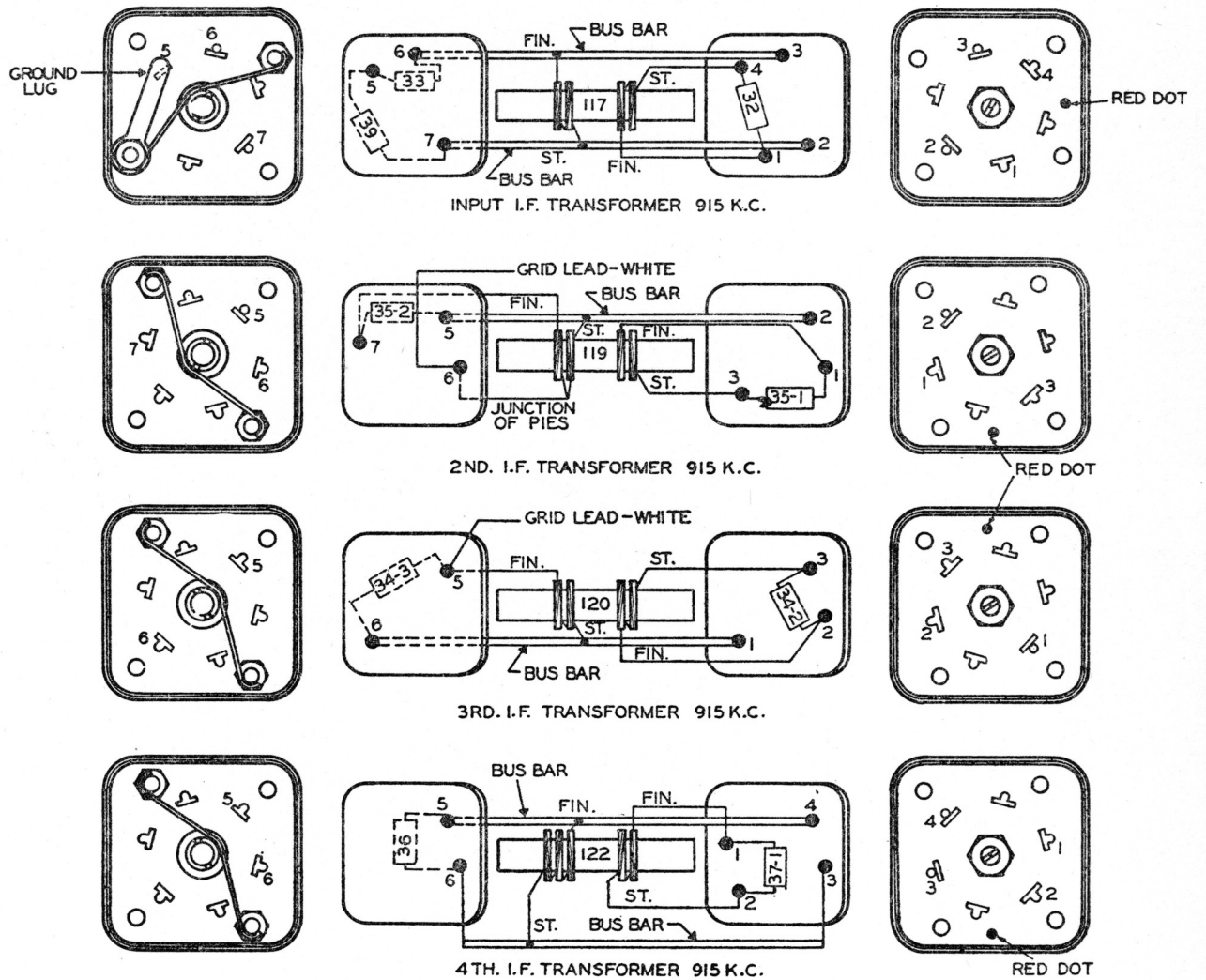

FIGURE 30—RADIO RECEIVER BC-348-H:  
WIRING DIAGRAM, I-F TRANSFORMERS

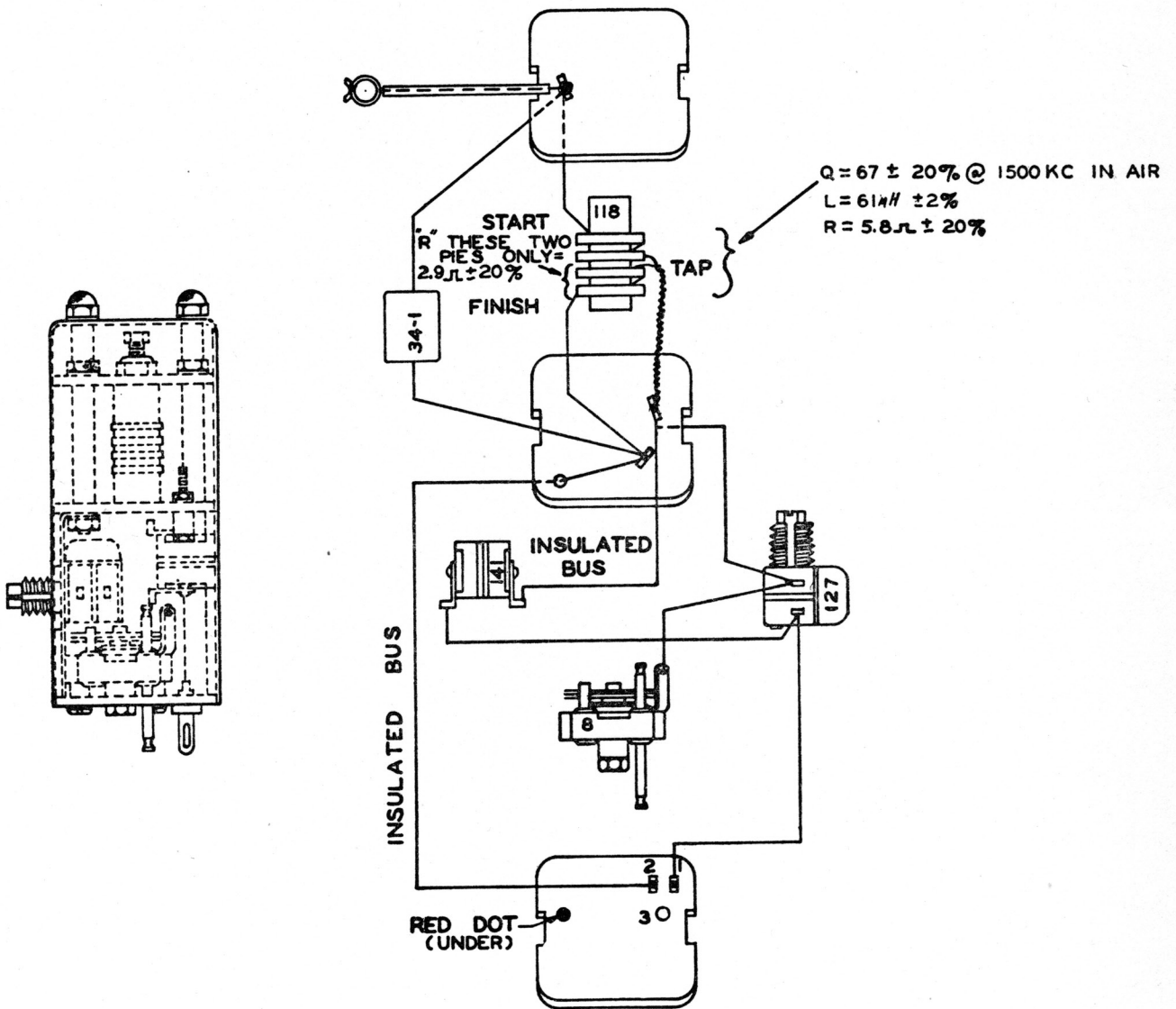
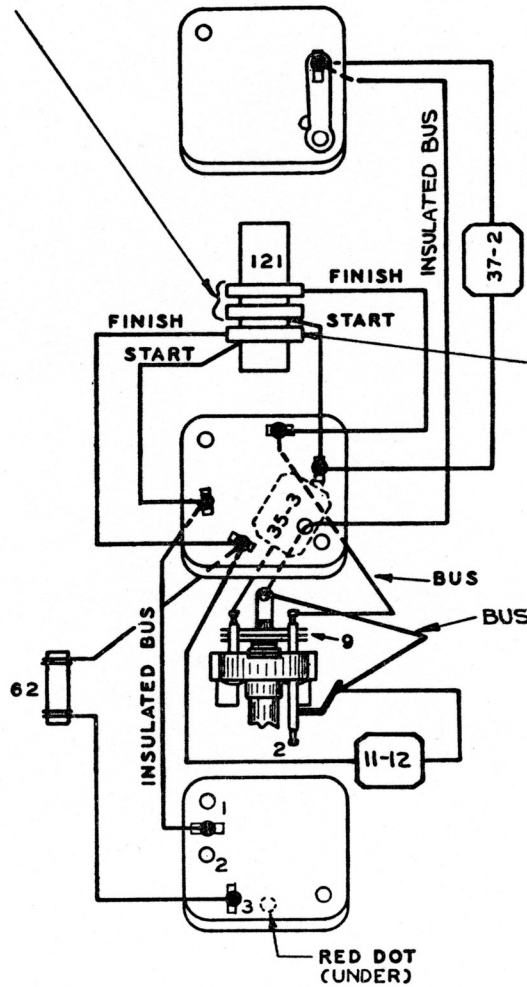
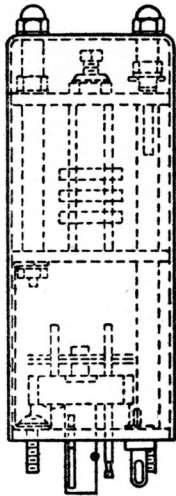

FIGURE 31—RADIO RECEIVER BC-348-H:  
 WIRING DIAGRAM, CRYSTAL FILTER

$Q = 103 \pm 20\%$  1000 KC (IN AIR)

$L = 66 \mu h \pm 2\%$

$R = 2 \Omega \pm 25\%$



$Q = 62 \pm 20\%$  @ 2500 KC (IN AIR)

$L = 35 \mu h \pm 2\%$

$R = 1.25 \Omega \pm 20\%$

FIGURE 32—RADIO RECEIVER BC-348-H:  
WIRING DIAGRAM, BEAT FREQUENCY  
OSCILLATOR

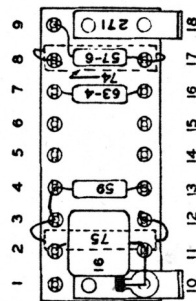
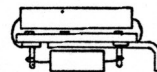
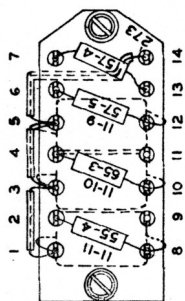
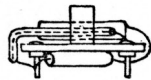
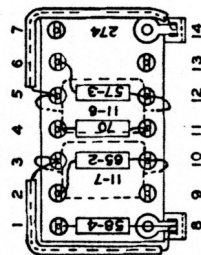
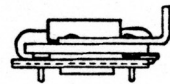
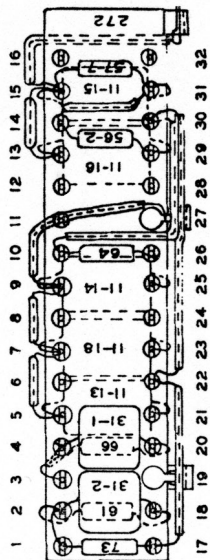
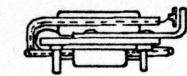

FIGURE 33—RADIO RECEIVER BC-348-H:  
WIRING DIAGRAM, RESISTOR BOARDS

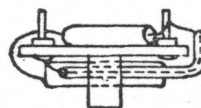
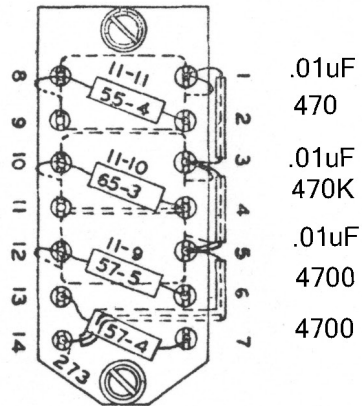
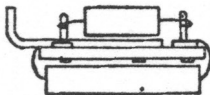
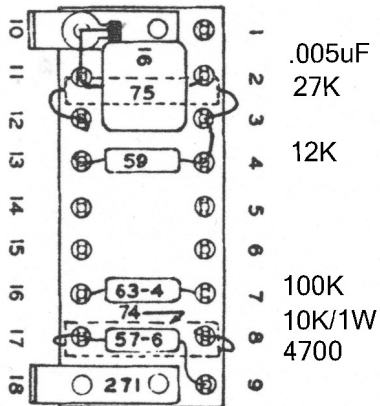
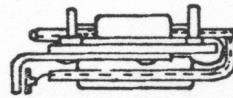
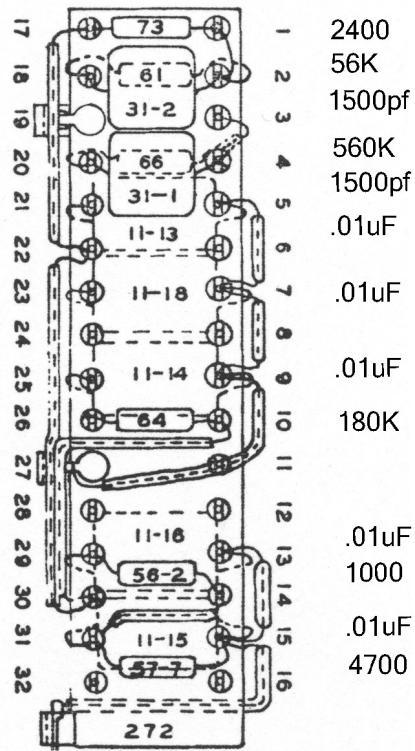
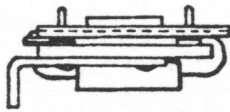
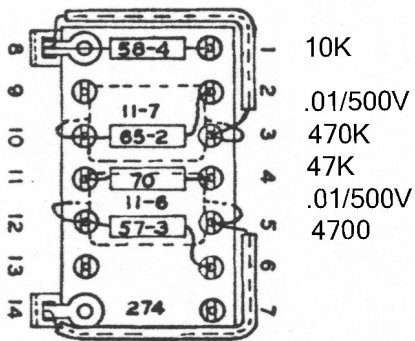

FIGURE 33—RADIO RECEIVER BC-348-H:  
 WIRING DIAGRAM, RESISTOR BOARDS

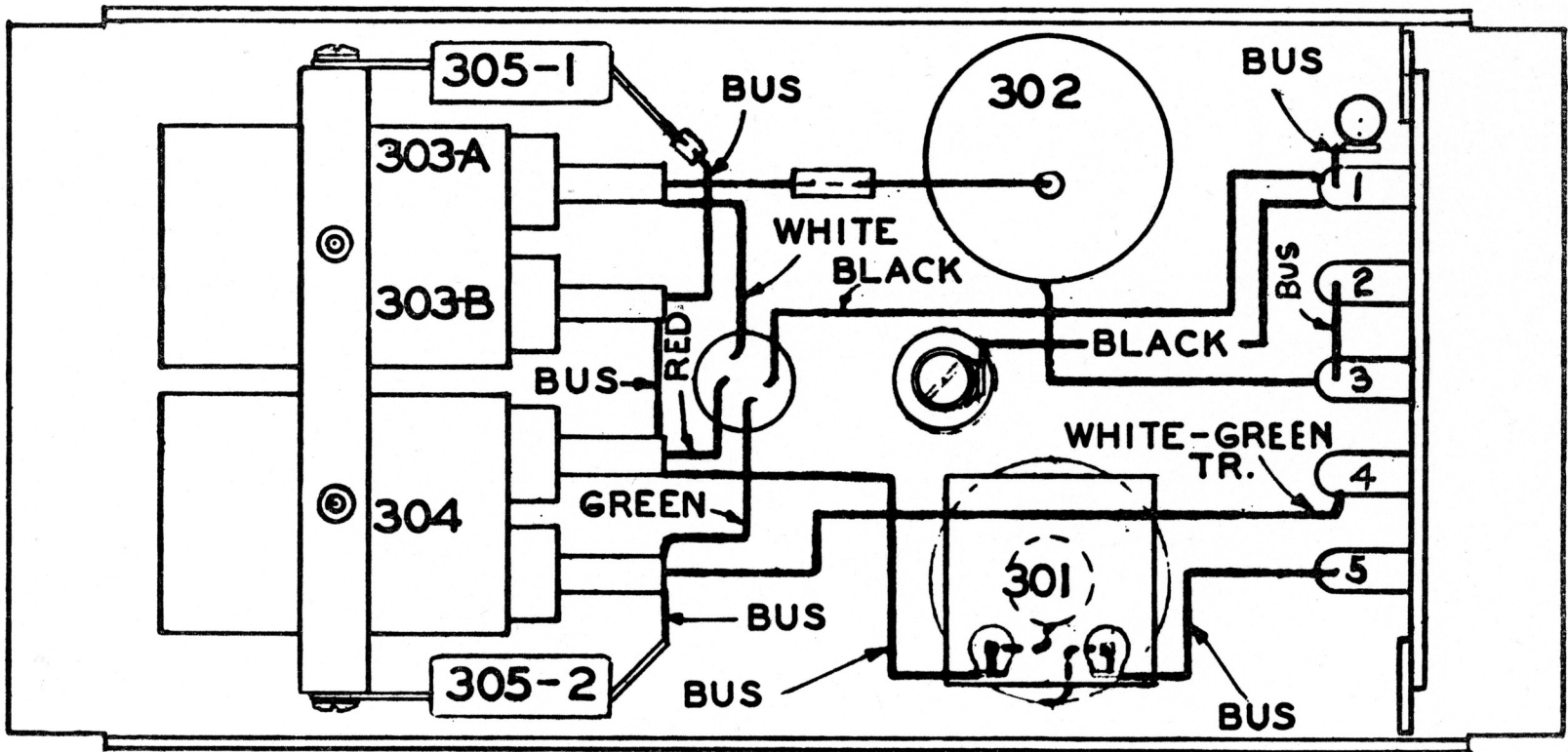

FIGURE 34—RADIO RECEIVER BC-348-H:  
WIRING DIAGRAM, DYNAMOTOR ASSEMBLY

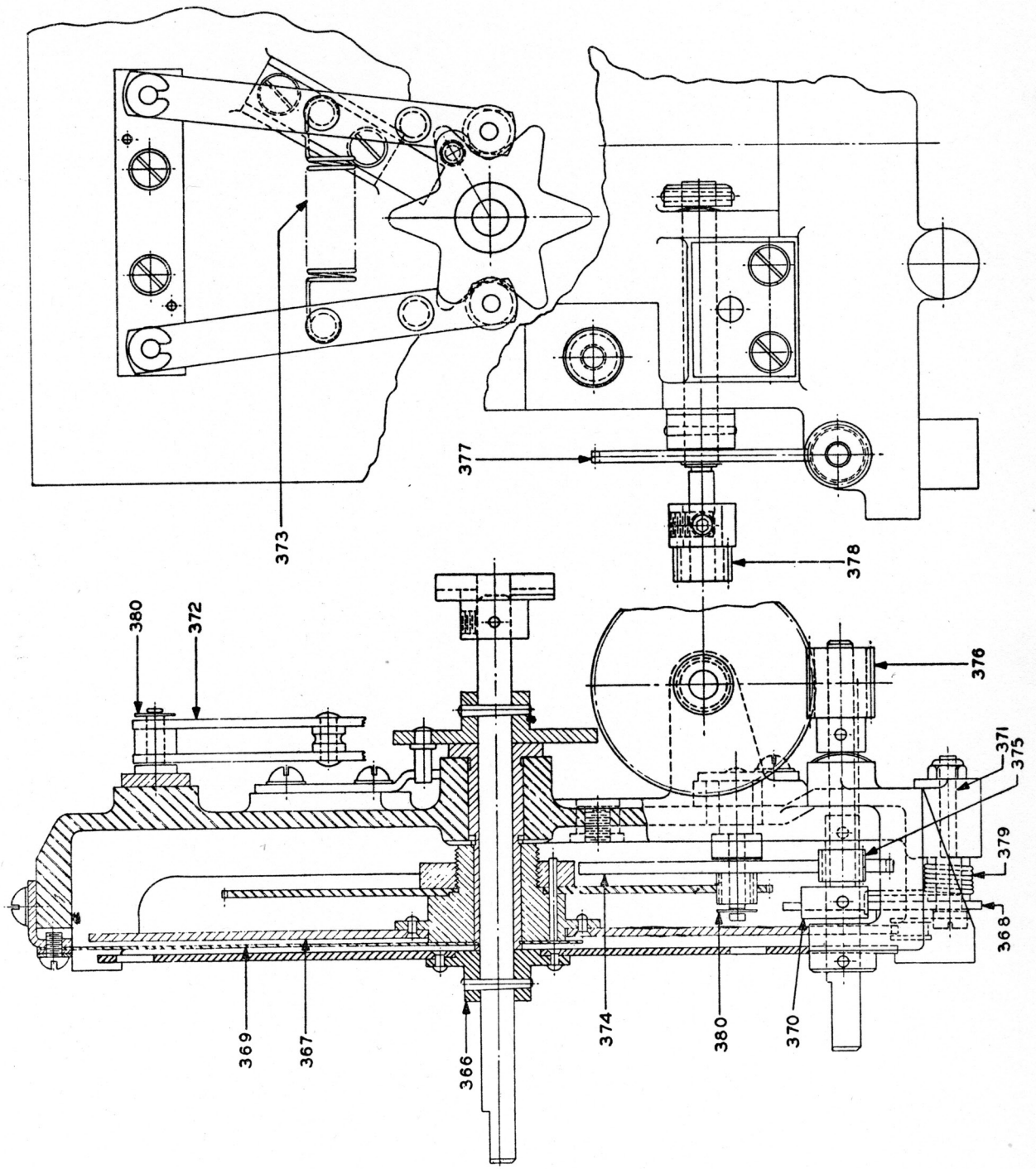

FIGURE 35—RADIO RECEIVER BC-348-H:  
DIAL AND MASK ASSEMBLY

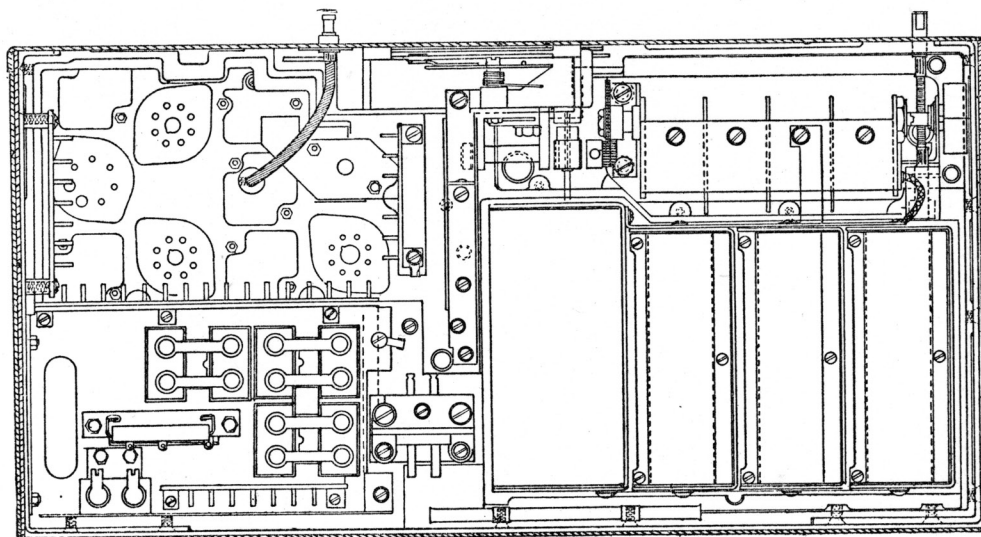
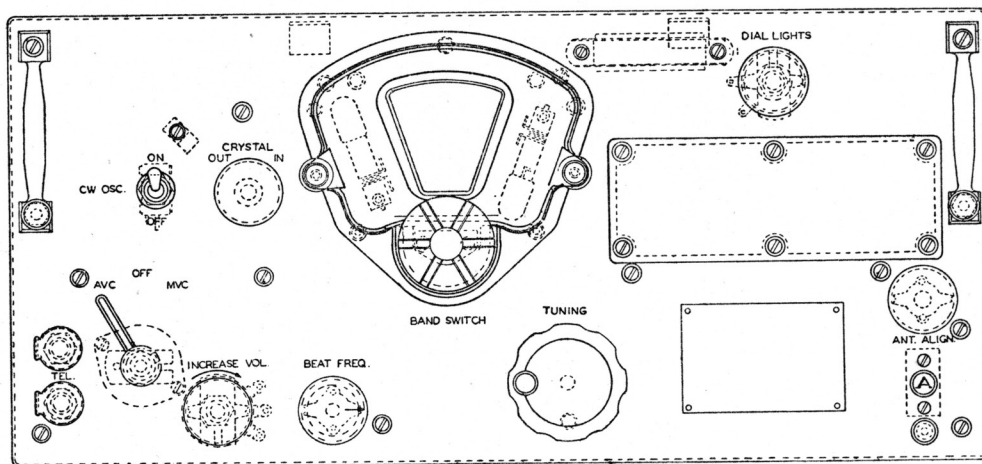
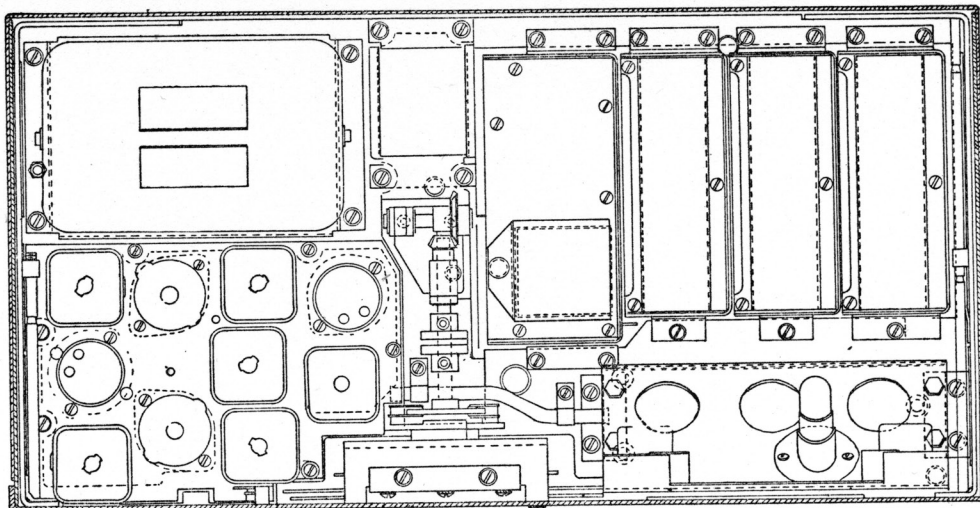

FIGURE 36—RADIO RECEIVER BC-348-H:  
GENERAL VIEW OF RECEIVER



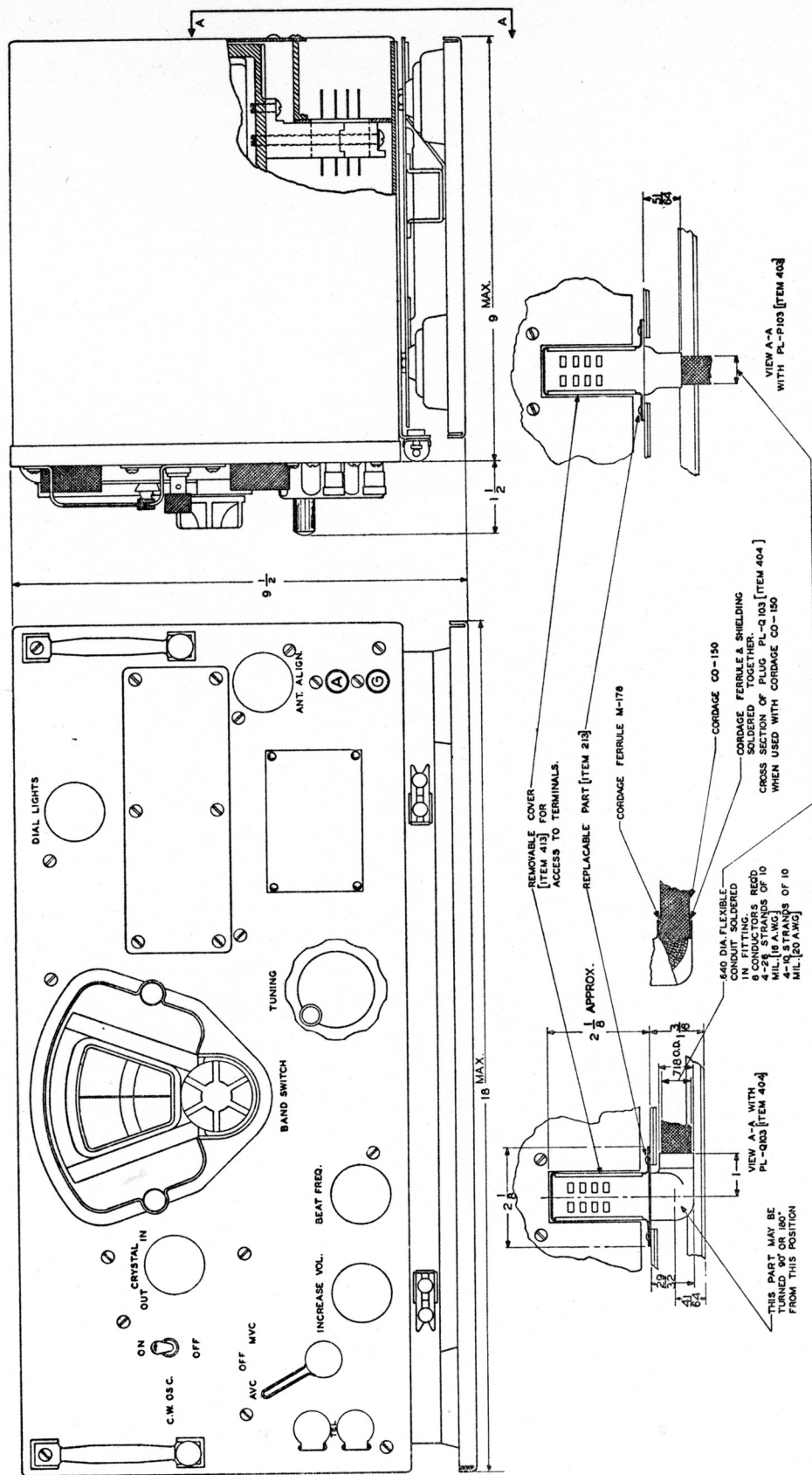
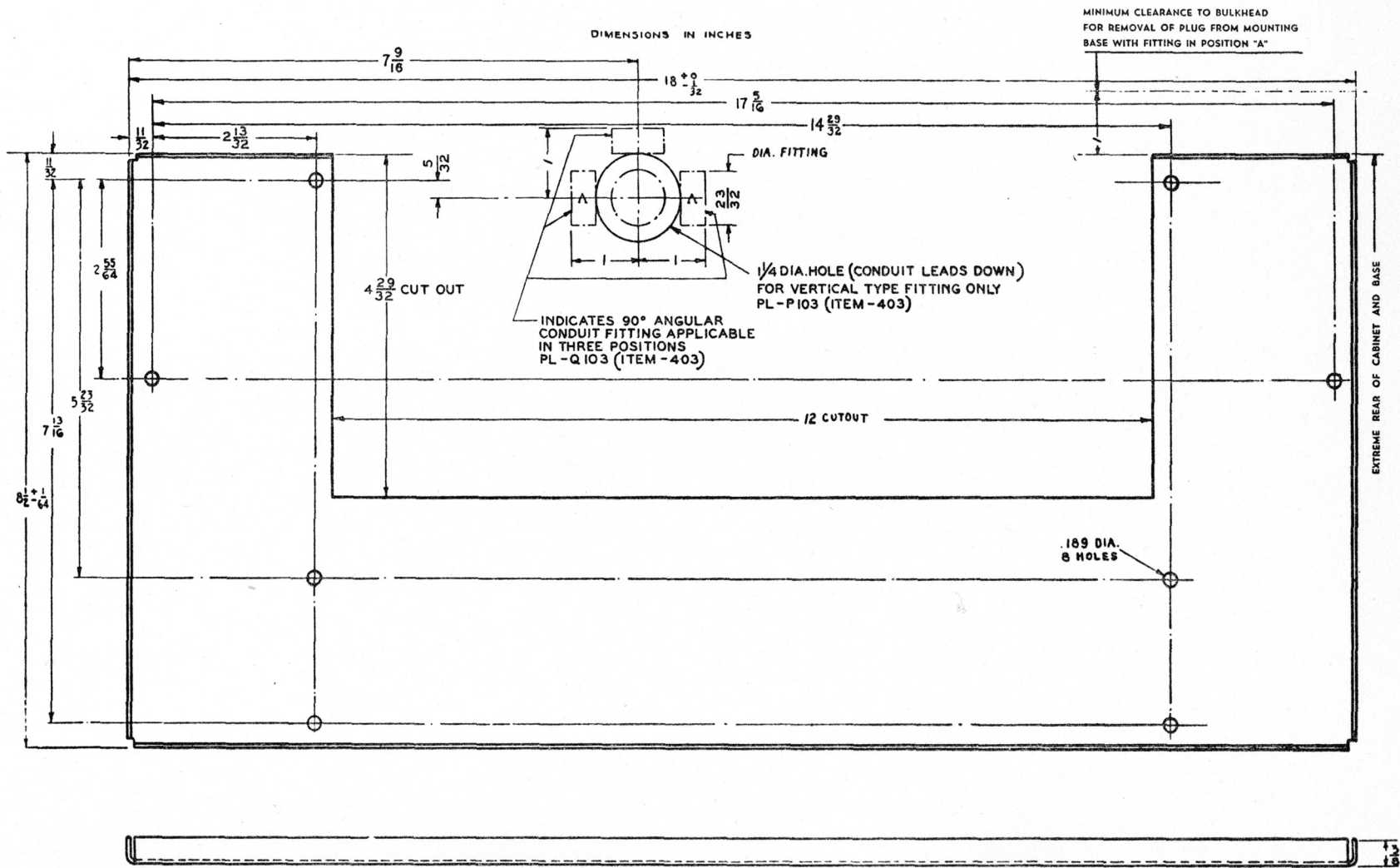

FIGURE 37—RADIO RECEIVER BC-348-H:  
OUTLINE DIMENSIONAL DRAWING



85

FIGURE 38—RADIO RECEIVER BC-348-H:  
DRILLING PLAN