

REPAIR INSTRUCTIONS FOR
RADIO RECEIVERS BC-312
-A, -C, -D, -E, -F, -G, -J,
-L, -M, -N, -HX, AND -NX,
AND BC-342, -A, -C, -D,
-F, -J, -L, -M, AND -N



WAR DEPARTMENT

FEBRUARY 1945

RESTRICTED. DISSEMINATION OF RESTRICTED MATTER.

No person is entitled solely by virtue of his grade or position to knowledge or possession of classified matter. Such matter is entrusted only to those individuals whose official duties require such knowledge or possession.

(See also paragraph 23b, AR 380-5, 15 March 1944.)

P. A. No. 22, 55 7025-23
E-2 R B



REPAIR INSTRUCTIONS FOR
RADIO RECEIVERS BC-312
-A, -C, -D, -E, -F, -G, -J,
-L, -M, -N, -HX, AND -NX,
AND BC-342, -A, -C, -D,
-F, -J, -L, -M, AND -N



WAR DEPARTMENT

FEBRUARY 1945

RESTRICTED. *DISSEMINATION OF RESTRICTED MATTER.*
No person is entitled solely by virtue of his grade or position to knowledge or possession of classified matter. Such matter is entrusted only to those individuals whose official duties require such knowledge or possession.

(See also paragraph 23b, AR 380-5, 15 March 1944.)

WAR DEPARTMENT

WASHINGTON 25, D. C., 10 February 1945.

TM 11-4001, Repair Instructions for Radio Receivers BC-312, -A, -C, -D, -E, -F, -G, -J, -L, -M, -N, -HX and -NX and BC 312, -A, -C, -D, -F, -J, -L, -M, and -N, is published for the information and guidance of all concerned.

[AG 300.7 (19 Jan 45)]

By ORDER OF THE SECRETARY OF WAR:

OFFICIAL:

J. A. ULIO
Major General
The Adjutant General

G. C. MARSHALL
Chief of Staff

DISTRIBUTION:

AAF (2); AGF (2); ASF (2); T of Opn (2); Dept (2); Def Comd (2);
Arm & Sv Bd (2); S Div ASF (1); Tech Sv (2); Sv C (2); FE (2); Gen
Oversea SOS Dep (Sig Sec) (2); Dep 11 (2); Gen & Sp Sv Sch (2);
USMA (2); WDGS Lib (5); Lab 11 (2); A (2); Three (3) copies to each
of the following: T/O & E 11-107; 11-127; 11-287; 11-500, Sig Sv
Orgn-Team EG; 11-587; 11-592; 11-597.

For explanation of symbols, see FM 21-6.

15221 E

CONTENTS

SECTION I. DESCRIPTION OF RADIO RECEIVERS BC-312-(*) AND BC-342-(*)

	Paragraph	Page
General.....	1	1
Over-all system function.....	2	3
Simplified circuit analysis.....	3	4
II. DIFFERENCES BETWEEN MODELS.		
Functional differences.....	4	6
Design differences.....	5	7
III. INITIAL REPAIR PROCEDURES.		
General.....	6	8
Tools, test, and cleaning equipment.....	7	8
Removal of tubes.....	8	8
Removal of dynamotor or rectifier.....	9	8
Cleaning, inspection, and lubrication of chassis assembly.....	10	10
Cleaning, inspection, and testing of tubes.....	11	10
Dynamotor repair.....	12	10
Rectifier repair.....	13	12
IV. PRELIMINARY TROUBLE-SHOOTING PROCEDURES.		
Input resistance measurements.....	14	14
Operating test.....	15	14
V. ALIGNMENT PROCEDURE.		
Calibration of test equipment.....	16	16
I-f alignment.....	17	17
R-f oscillator alignment.....	18	18
R-f and first detector alignment.....	19	19
C-w oscillator alignment.....	20	21
Crystal filter alignment.....	21	21
VI. DETAILED TROUBLE-SHOOTING PROCEDURES.		
Localizing trouble to specific stage.....	22	22
Checking audio circuit.....	23	22
Use of stage gain charts.....	24	22
Signal substitution.....	25	23
Signal tracing.....	26	24
Measuring individual stage gain.....	27	24
Checking c-w oscillator operation.....	28	25
Checking crystal filter operation.....	29	25
Voltage and resistance measurements.....	30	26
Moistureproofing, fungiproofing and refinishing.....	31	26
VII. FINAL TESTING.		
Alignment check.....	32	27
Signal-to-noise ratio test.....	33	28
M-c-w sensitivity test.....	34	28
C-w sensitivity test.....	35	28
Crystal filter sensitivity test.....	36	29
Selectivity test.....	37	29
Dial deviation test.....	38	30
Output overload test.....	39	31
Operational test.....	40	31

VIII. INDIVIDUAL STAGE AND CIRCUIT REPAIR DATA.

	<i>Paragraph</i>	<i>Page</i>
Antenna circuit.....	41	32
First r-f amplifier.....	42	34
Second r-f amplifier.....	43	36
R-f oscillator.....	44	38
First detector.....	45	40
First i-f amplifier.....	46	42
Second i-f amplifier.....	47	44
Second detector and first audio amplifier.....	48	46
C-w oscillator.....	49	48
Second audio amplifier.....	50	50
Power supply.....	51	52
Noise suppression circuit.....	52	54
A-v-c and M-v-c circuits.....	53	55

IX. SUPPLEMENTARY DATA. PARTS IDENTIFICATION.....	54	56
---	----	----

RESTRICTED

SECTION I

DESCRIPTION OF RADIO RECEIVERS BC-312-(*) AND BC-342-(*)

1. General

a. Radio Receivers BC-312-(*) and BC-342-(*) except for power supply, are basically identical. Radio Receiver BC-312-(*) uses a battery-operated dynamotor; Radio Receiver BC-342-(*) operates from an a-c (alternating-current) power supply. Superheterodyne receivers designed for use in vehicles or in fixed stations, they are capable of receiving voice, tone, or c-w (continuous-wave) transmitted signals over the frequency range of 1,500 to

18,000 kc (kilocycles) or 1.5 to 18 mc (megacycles). The frequency range is divided into six bands: 1,500 to 3,000 kc, 3,000 to 5,000 kc, 5,000 to 8,000 kc, 8,000 to 11,000 kc, 11,000 to 14,000 kc, and 14,000 to 18,000 kc. The BAND CHANGE switch controls the choice of frequency range. A VERNIER control equipped with a locking device and a FAST TUNING control are provided for tuning. An ALIGN INPUT control mounted on the front panel provides a means of obtaining the greatest sen-

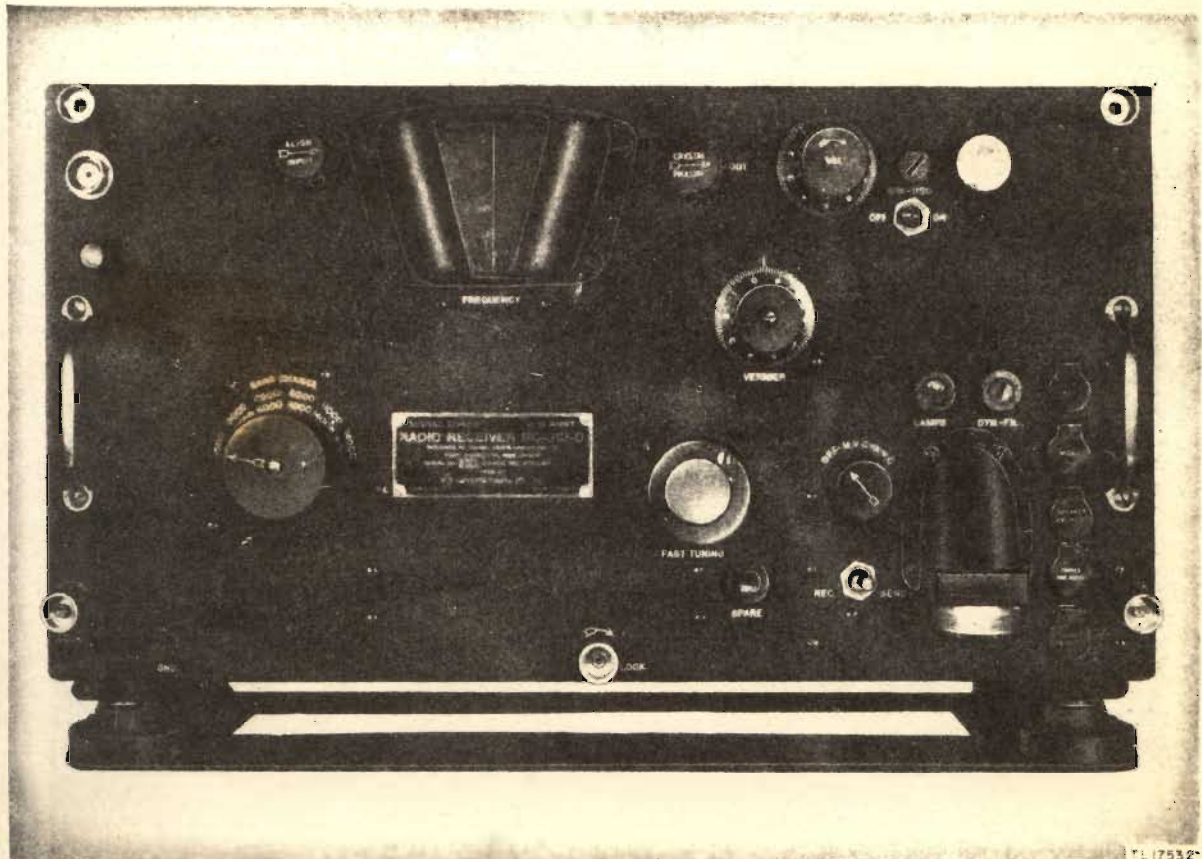

Figure 1. Radio Receiver BC-312-D, front view.

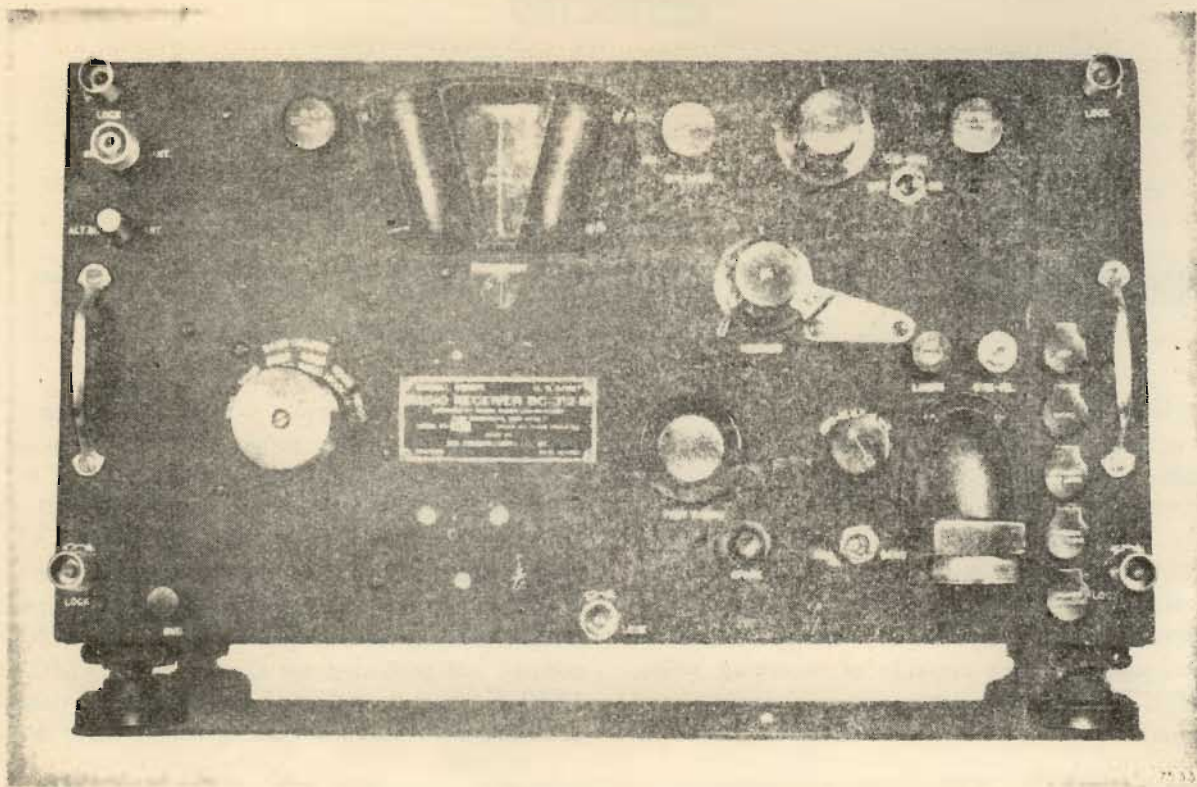

Figure 2. Radio Receiver BC-312-M, front view.

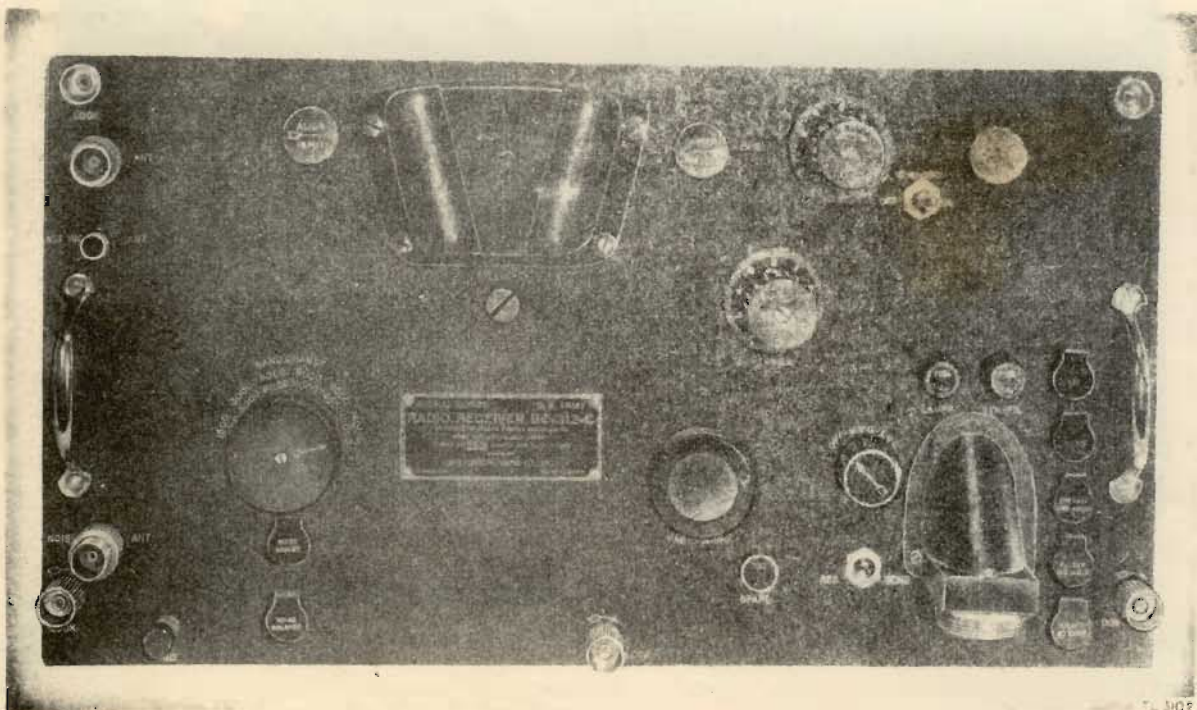

Figure 3. Radio Receiver BC-312-C, front view.

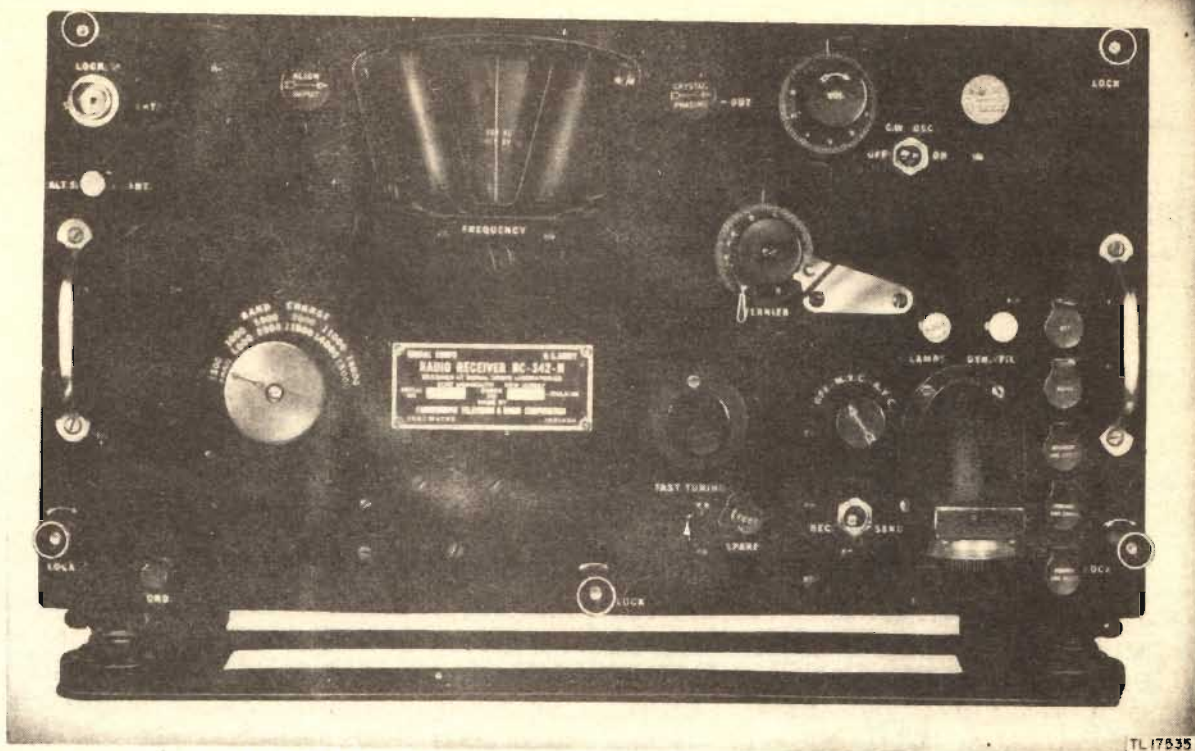

Figure 4. Radio Receiver BC-342-N, front view.

sitivity at any one dial setting. Figures 1, 2, 3, and 4 show front views of these receivers.

b. Throughout this manual, where text applies equally to all models of a given series of an item, the suffix letter is omitted and the symbol (*) is used. For example, Radio Receiver BC-312-(*) refers to Radio Receivers BC-312 -A, -C, -D, -E, -F, -G, -J, -L, -M, -N, -HX, and -NX. A specific model letter is used only when particular models must be identified. If no differences occur, all models of both designs are referred to as "the receiver."

c. An a-v-c (automatic-volume-control) circuit is incorporated in the receiver and may be used or cut out of the circuit as needed, by turning the OFF-M. V. C.-A. V. C. switch to either the M. V. C. (manual-volume-control) or A. V. C. position. Turning the OFF-M. V. C.-A. V. C. switch to the A. V. C. position switches the automatic volume control into the circuit, providing a-v-c control of the received signal. Turning the OFF-M. V. C.-A. V. C. switch to M. V. C. position switches the automatic volume control out of the circuit. In the M. V. C. position, the receiver is most sensitive.

d. A beat-frequency oscillator is incorporated

in the receiver so that c-w signals may be received. A C.W.-OSC. ON-OFF switch is used to turn the beat-frequency oscillator on or off. The CW-OSC-ADJUST control is used to change the pitch of c-w signals.

e. The receiver is so designed that the individual r-f (radio-frequency), r-f oscillator, c-w oscillator, and power supply components can be removed from the chassis with a minimum of disturbance to other parts. This type of construction provides effective shielding between stages, and facilitates maintenance.

2. Over-All System Function

The circuit used in Radio Receivers BC-312-(*) and BC-342-(*) consists of two stages of tuned r-f amplification; a first detector and mixer stage; an RFO (radio-frequency oscillator) stage; two stages of i-f (intermediate-frequency) amplification; a second detector, a-v-c rectifier, first a-f (audio-frequency) amplifier stage; an a-f output stage; and a beat-frequency (or c-w) oscillator stage, to provide a beat note for c-w reception. A crystal filter circuit is incorporated in Radio Receivers BC-312 through BC-312-J, BC-312-HX, and BC-342-(*), but is not

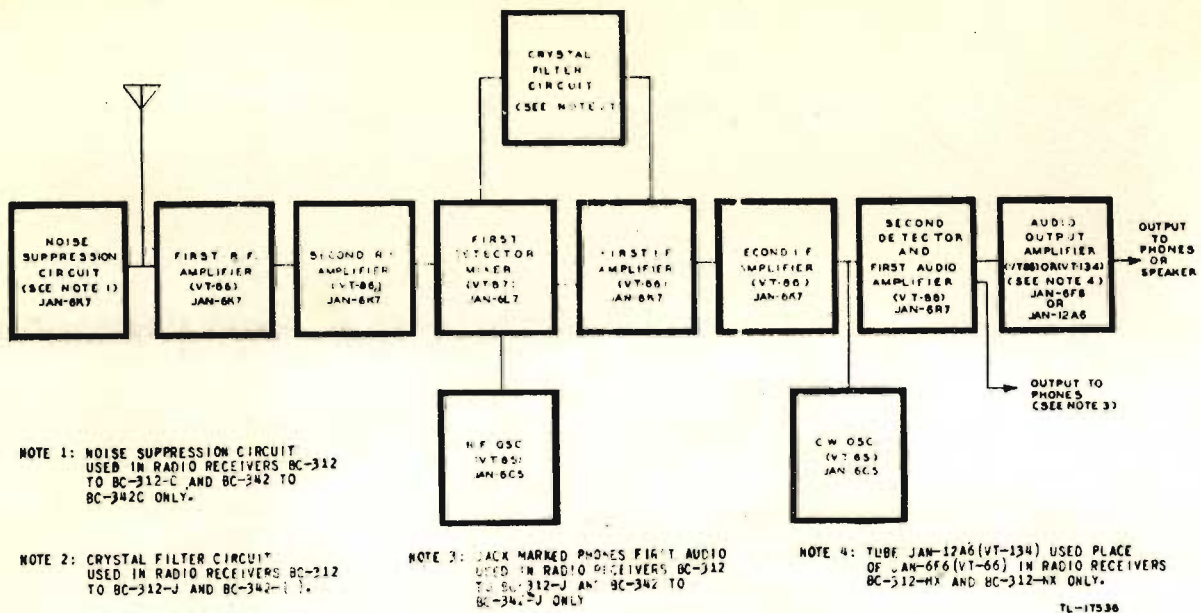

Figure 5. Radio Receivers BC-312-(*), BC-312-(*), and BC-342-(*), block diagram.

used in Radio Receivers BC-312 L through BC-312-N and BC-312-NX. A noise suppression circuit was used in the antenna circuit of Radio Receivers BC-312, BC-312-A, BC-312-C, BC-342, and BC-342-C. Figure 5 shows a simplified block diagram of the receiver.

3. Simplified Circuit Analysis.

Two stages of r-f amplification provide a high degree of selectivity and sensitivity at the same time rejecting interfering signals at intermediate or image frequencies. The RFO stage provides a local oscillator signal which beats against the incoming signal in the first detector and mixer stage to produce an i-f signal. The i-f stages provide additional selectivity and amplification. The second detector stage (also a-v-c rectifier

and first a-f amplifier) demodulates the signal, supplies a-v-c voltage to the preceding r-f and i-f amplifiers and the mixer stage, and amplifies the audio component. Further amplification is supplied by the a-f output stage. The c-w oscillator stage produces an r-f signal which differs from the i-f signal at an audio frequency. The resultant beat note permits c-w reception. The crystal filter circuit, when used, greatly increases the selectivity of the receiver. The noise suppression filter in the antenna circuit, when incorporated, tends to reduce motor ignition interference. Figure 6 shows a simplified functional circuit diagram of the receiver. For detailed functioning of circuits, refer to TM 11-850.

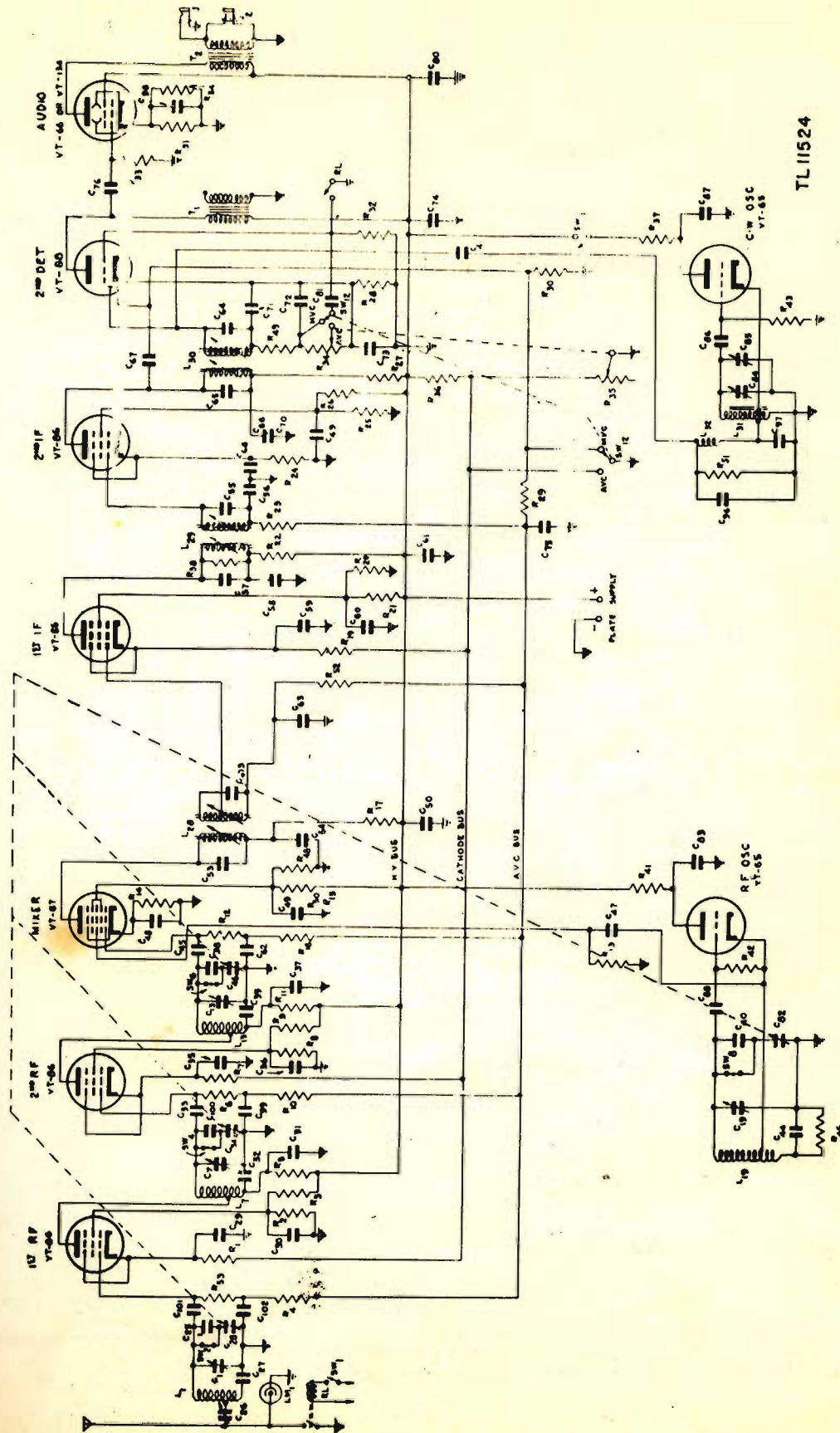

TL 11524

Figure 6. Radio Receivers BC-312-(*) and BC-342-(*) simplified functional circuit diagram.

SECTION II

DIFFERENCES BETWEEN MODELS

4. Functional Differences

Functional differences in Radio Receivers BC-312-(*) and BC-342 (*) are listed below:

a. RADIO RECEIVER BC-312-(*)

Radio Receiver	External voltage supply	Input power	Oscillator compartment heaters	Noise balancing system	Crystal filter circuit	Weight (lb)	Description
BC-312	12 14 v d-c	80 100	x	x	x	58	Uses Dynamotor DM-17-A.
BC-312-A	12 14 v d-c	50 60	x	x	x	56	Uses DM-21-A, -B, -G, -J, -L, -M, -P, and -S.
BC-312-C	12-14 v d-c	50 60		x	x	56	Do.
BC-312-D	12-14 v d-c	50 60			x	56	Do.
BC-312-E	12 14 v d-c	50 60			x	56	Do.
BC-312-F	12 14 v d-c	50 60			x	56	Do.
BC-312-G	12 14 v d-c	50 60			x	56	Do.
BC-312-J	12 14 v d-c	50 60			x	56	Do.
BC-312-L	12 14 v d-c	50 60				56	Do. (note 1).
BC-312-M	12 14 v d-c	50 60				56	Do.
BC-312-N	12 14 v d-c	50-60				56	Do.
BC-312-HX	24 28 v d-c	25-35			x	48	Uses Dynamotor DM-21 CX. (note 2).
BC-312-NX	24 28 v d-c	25 35				48	Uses Dynamotor DM-21 CX.

Notes 1. In Radio Receivers BC-312-L through BC-312-N and BC-312-NX, the antenna relay disables antenna circuit and first audio circuit, and all phone jacks are marked PHONES SECOND AUDIO.

2. In Radio Receivers BC-312-HX and BC-312-NX, Tube JAN-12A6 (VT-134) is used in place of Tube JAN-6F6 (VT-66) in the audio output stage.

3. x indicates model in which functional difference appeared.

b. RADIO RECEIVER BC-342-(*)

Radio Receiver	External voltage supply	Input power	Oscillator compartment heaters	Noise balancing system	Crystal filter circuit	Weight
BC-342	110 120 v a-c	100	x	x	x	61.5
BC-342-A	110 120 v a-c	100	x	x	x	61.5
BC-342-C	110 120 v a-c	75		x	x	61.5
BC-342-D	110 120 v a-c	75			x	61.5
BC-342-F	110 120 v a-c	75			x	61.5
BC-342-H	110 120 v a-c	75			x	61.5
BC-342-J	110 120 v a-c	75			x	61.5
BC-342-L (note 1)	110 120 v a-c	75			x	61.5
BC-342-M	110 120 v a-c	75			x	61.5
BC-342-N	110 120 v a-c	75			x	61.5

Notes 1. In Radio Receivers BC-342-L through BC-342-N, antenna relay disables antenna circuit and first audio circuit, and all phone jacks are marked PHONES SECOND AUDIO.

2. x indicates model in which functional difference appeared.

5. Design Differences

Design differences in the various models of the receivers are listed below:

a. RADIO RECEIVER BC-312 (*).

Design differences	BC-312	BC-312-A	BC-312-C	BC-312-D	BC-312-E	BC-312-F	BC-312-G	BC-312-J	BC-312-L	BC-312-M	BC-312-N	BC-312-IX	BC-312-NX
Thermostatically controlled heater in r-f oscillator compartment removed		X	X	X	X	X	X	X	X	X	X	X	X
Glass-enclosed i-f transformers replaced by conventional type		X	X	X	X	X	X	X	X	X	X	X	X
Shielded alternate antenna post replaced by unshielded type			X	X	X	X	X	X	X	X	X	X	X
Dynamotor DM-17-A replaced by DM-21- (*)		X	X	X	X	X	X	X	X	X	X	X	X
Tube shelf mounted at an angle			X	X	X	X	X	X	X	X	X	X	X
FAST TUNING dial assembly modified			X	X	X	X	X	X	X	X	X	X	X
Shielded alternate antenna post eliminated		X											
Antenna noise suppression circuit eliminated				X	X	X	X	X	X	X	X	X	X
Tube JAN-6F6 (VT-66) replaced by JAN-12A6 (VT-134)												X	X
All phone jacks second audio									X	X	X	X	X
Antenna disabling relay also disables first audio circuit									X	X	X	X	X
Oscillator compartment heat insulator removed									X	X	X		X
Crystal filter circuit removed									X	X	X		X
Pilot lamp rheostat added									X	X	X		X
Steel substituted for aluminum in chassis and housing									X	X	X		X
Paper and ceramic capacitors substituted for mica									X	X	X		X
Audio output transformer changed to provide either 250- or 4,000-ohm impedance output										X	X		

Note. x indicates model in which change was incorporated.

b. RADIO RECEIVER BC-342-(*).

Design differences	BC-342	BC-342-A	BC-342-C	BC-342-D	BC-342-F	BC-342-J	BC-342-L	BC-342-M	BC-342-N
Thermostatically controlled heater in r-f oscillator compartment removed		X	X	X	X	X	X	X	X
Glass-enclosed i-f transformers replaced by conventional type		X	X	X	X	X	X	X	X
Shielded alternate antenna post replaced by unshielded type			X	X	X	X	X	X	X
Tube shelf mounted at an angle			X	X	X	X	X	X	X
FAST TUNING dial assembly modified			X	X	X	X	X	X	X
Shielded alternate antenna post eliminated			X						
Antenna noise suppression circuit eliminated				X	X	X	X	X	X
Tube JAN-6F6 (VT-66) replaced by JAN-12A6 (VT-134)									
All phone jacks second audio							X	X	X
Antenna disabling relay also disables first audio circuit							X	X	X
Oscillator compartment heat insulator removed							X	X	X
Steel substituted for aluminum in chassis and housing							X	X	X
Paper and ceramic capacitors substituted for mica							X	X	X
Audio output transformer changed to provide either 250 or 4,000-ohm impedance output								X	X

Note. x indicates model in which change was incorporated.

SECTION III

INITIAL REPAIR PROCEDURES

6. General

The repair information in this and the following sections is presented in the order in which the repairman actually should perform the various operations on the equipment in the repair shop. This procedure permits repair of the equipment in the shortest time possible, resulting in sensitivity, selectivity, and over-all performance of the set comparable to that of new equipment.

7. Tools, Test, and Cleaning Equipment

The following items should be available for repairing and servicing this equipment:

a. TOOLS AND ACCESSORIES.

Item	Description
Screw drivers and pliers.	Assorted sizes.
Alignment tools	Fiber.
Soldering iron and solder.	
Capacitor	50-mmf; mica; for r-f alignment.
Resistor	300-ohm; noninductive; for i-f alignment.
Headset or loud-speaker.	4,000-ohm impedance.
Battery	12- or 24-volt.
Battery cord	
Plug PL-55 (or equivalent).	For output meter.

b. TEST EQUIPMENT.

Item	Description
Signal generator	Covering frequencies of 470 kc for i-f alignment and 1,500 kc to 18 mc for r-f alignment; calibrated or metered output voltage of approximately 0 to 1 volt, providing a 400 cycle 30% modulated and CW signal.
Audio signal generator.	
Frequency meter	Covering frequencies of 1,500 kc to 18 mc; signal generator frequency check.

Item	Description
Voltohmmeter	Sensitivity of 1,000 ohms per volt; measuring a-c or d-c voltages from 10 to 500 volts, and resistances from 1 ohm to 15 megohms.
Voltohmmeter	Sensitivity of 20,000 ohms per volt; measuring a-c or d-c voltages from 10 to 500 volts, and resistances from 1 ohm to 15 megohms.
Voltmeter	Vacuum-tube; measuring a-c and d-c voltages from 0 to 100 volts.
Output meter	4,000-ohm impedance; 100-volt range.
Tube tester	

c. CLEANING EQUIPMENT.

Item	Description
Cleaning fluid	Solvent. Dry-cleaning, Federal Specification P-S-661a.
Petroleum spirits	
Brushes	Paint; ½-in. to 3-in. assorted sizes.
Pipe cleaners	Tobacco pipe.
Clean cloths	Lint-free.
Sandpaper	# 0000.
Crocus cloth	

8. Removal of Tubes

No tubes (with the exception of the c-w oscillator and r-f oscillator tubes) are inclosed; they may be removed by lifting grid caps and pulling tubes out of sockets. To remove the c-w oscillator tube, remove the top cover of the c-w oscillator shield (fig. 13), lift the grid cap, and pull the tube out of the socket. To remove the r-f oscillator tube, open the hinged cover of the r-f oscillator compartment (fig. 13), lift grid cap, and pull the tube out of the socket.

9. Removal of Dynamotor or Rectifier

To remove the dynamotor or rectifier assembly from the chassis, unscrew the two screws on top of the chassis (fig. 13.). Turn the chassis

upside down and remove the screw pin from the inner hinge. Swing the dynamotor or rectifier assembly away from the panel and disconnect

the leads from the dynamotor terminal board. Remove the screw pin from the outer hinge and lift the assembly from the chassis.

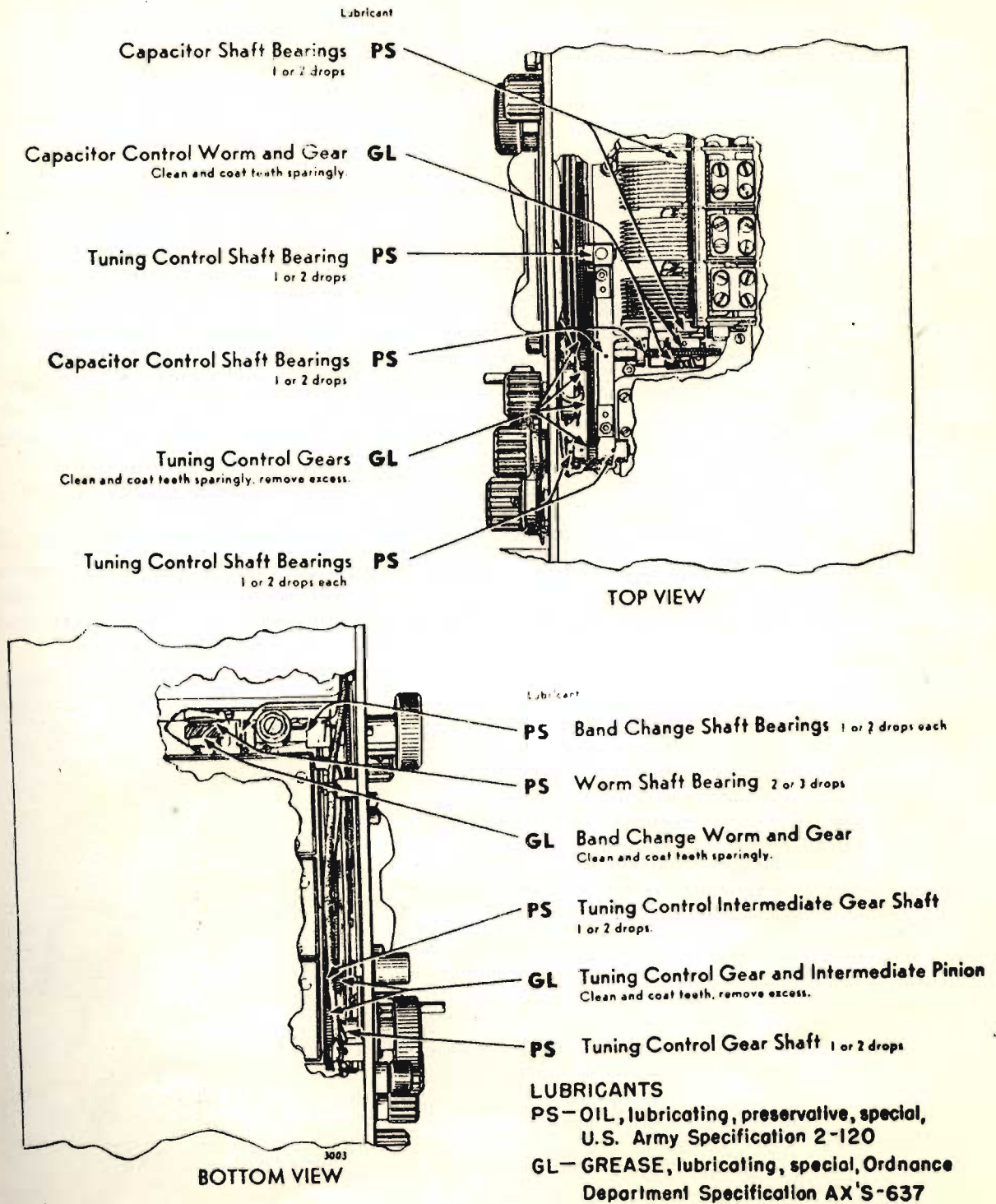

TL17538

Figure 7. Lubrication data.

10. Cleaning, Inspection, and Lubrication of Chassis Assembly

a. **CLEANING.** Thorough cleaning of the receiver is necessary to insure optimum performance by preventing corrosion, rust, and dust from damaging parts or causing arc-over or low resistance leakage between high-voltage points and ground. Remove loose dust and dirt with a brush or blower. With a brush or cloth and Solvent, Dry-cleaning, Federal Specification P-S-661a, remove dirt or grease which adheres to the chassis or parts. Remove the shield covers from the r-f, detector, and oscillator sections; clean the wave band switches with a small brush or pipe cleaner and dry-cleaning solvent. Clean the tuning capacitor bearings and rotor grounding springs with dry-cleaning solvent.

b. **INSPECTION.** After a receiver has been thoroughly and carefully cleaned, make a visual inspection of parts and wiring for rust, corrosion, loose connections, frayed or burned insulation, loose screws, and burned or charred resistors and coils. Carefully inspect tube sockets for broken contacts, wave band switches for loose or bent contacts or broken insulation, and terminal boards for broken lugs and signs of burning. Inspect and tighten all loose tun-

ing dial gears, setscrews, and antenna relay contacts. Check to determine that all modifications have been incorporated.

c. **LUBRICATION.** The receiver tuning dial bearings and gears are lubricated at the time of manufacture with sufficient lubricant to last the life of the equipment under normal conditions; however, if lubrication becomes necessary after cleaning or because of abnormal use, lubricate the parts as directed in figure 7.

11. Cleaning, Inspection, and Testing of Tubes

a. **CLEANING.** Clean tubes with a cloth moistened with dry-cleaning solvent; if necessary, clean grid caps and prongs with crocus cloth.

b. **INSPECTION.** Inspect tubes for cracks in glass or base, or for bent or broken prongs.

c. **TESTING.** Test tubes for low emission, leakage, and short circuits with a tube tester, or by placing doubtful tubes in a receiver known to be operating normally.

12. Dynamotor Repair

a. **PRELIMINARY INSPECTION.** Remove dynamotor assembly from receiver chassis as directed in paragraph 9. Remove cover from dynamotor assembly. Wipe off loose external

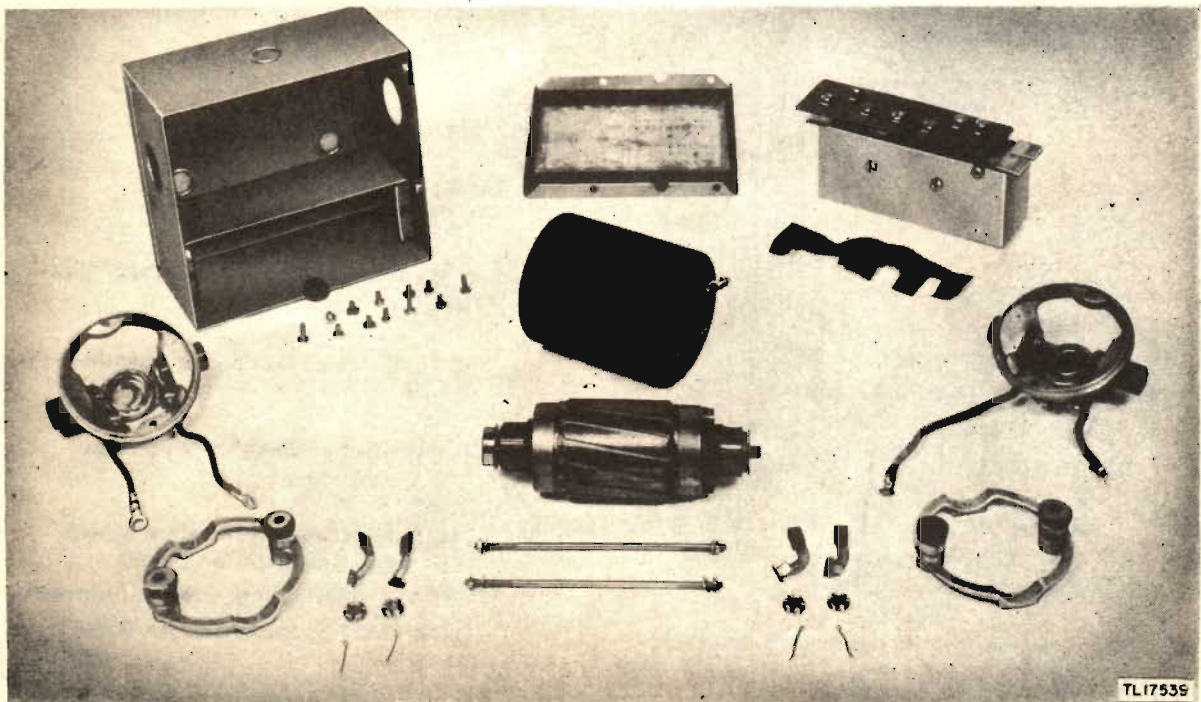

Figure 8. Dynamotor parts.

dirt and dust with a cloth moistened with petroleum spirits. Test dynamotor on available dynamotor test equipment for voltage output at no load and at rated load; check for vibration and sparking at brushes. Tag dynamotor to indicate faults.

Note. Replace dynamotors which have open windings, defective bearings, or worn commutators, with new complete units.

b. CLEANING (FIG. 8). Do not dismantle dynamotors which operate normally and have only small deposits of carbon dust on brush holders. Clean them with a cloth moistened with petroleum spirits. Dismantle dynamotors which show evidence of excessive use and large deposits of carbon dust and grease; clean as follows:

(1) Remove the dynamotor from the housing by removing the four screws in each end of the case and disconnecting the leads.

(2) Remove the brush holder caps and brushes on both low-voltage and high-voltage ends. Mark each brush so that it can be replaced in the same position in the same holder.

(3) Disconnect the leads to the brush holders; mark each lead so that it may be connected properly when the unit is reassembled.

(4) Remove the nuts on the tie rods at the high-voltage end, and remove bearing bracket.

(5) Pull out the armature.

(6) Remove the bearing bracket from the low-voltage end.

(7) Clean the bearing brackets, brush holders, bearing cover plates, and spacer shims with a cloth moistened with petroleum spirits.

(8) Blow loose dust and dirt out of stator assembly; if necessary, clean metal parts with #0000 sandpaper and petroleum spirits. Blow out resultant sand and metal fillings with compressed air. Field coils may be cleaned with a small sash brush and wiped with a cloth moistened with petroleum spirits.

(9) Clean the armature, including the commutator, with a cloth moistened with petroleum spirits; wipe with a clean cloth.

(10) If the commutator is slightly rough, smooth with #0000 sandpaper. Remove sand and metal fillings with a small piece of coarse canvas. Cover the bearings before cleaning the armature and commutator.

Caution: Do not use carbon tetrachloride or emery cloth on commutator.

(11) Remove old, hardened lubricant from the bearings with a small brush and petroleum spirits; apply one drop of light lubricating oil. Work oil in by rotating the bearing.

Note. If commutator is badly worn or damaged or bearings are defective, replace complete dynamotor unit with a new unit.

c. REASSEMBLY.

(1) Insert the spacer shims in the bearing bracket; mount the bearing bracket on the low-voltage end of the stator assembly.

(2) Connect the wires to the brush holder.

(3) Insert the spacer shims in the bearing bracket; slide the bearing on the high-voltage end of the armature into the high-voltage bearing bracket.

(4) Slide the armature into place through the stator assembly.

(5) Insert the tie bolts through the stator assembly and tighten the nuts.

(6) Connect the wires to the high-voltage brush holder.

(7) Check end play in armature (should be 0.005 to 0.015 in.).

(8) Pack outer side of each bearing two-thirds full of Grease, General Purpose No. 2, U. S. specification 2-108; replace grease-retainer cap screw.

d. REPLACEMENT OF BRUSHES. Before re-installing brushes which have been used in a unit, examine each one for broken or loose pig tails, bent or burned springs, and excessive wear. Low-voltage brushes which are less than $\frac{3}{8}$ -inch long and high-voltage brushes which are less than $\frac{7}{16}$ -inch long or otherwise defective, should be replaced with new brushes. Run the dynamotor for at least 4 hours with a light load, to allow new brushes to seat properly.

e. FILTER PACK (Figs. 9 and 10). If the dynamotor output voltage is low, if no output is obtained, or if the dynamotor will not start when connected to Filter FL-6-(*), check chokes and capacitors for open or short circuits.

f. REASSEMBLY IN HOUSING AND FINAL TESTING. Reassemble the dynamotor in the housing and connect the leads to the filter pack connections. Test the dynamotor on available dynamotor test equipment for output voltage, output current, ripple voltage, and in-

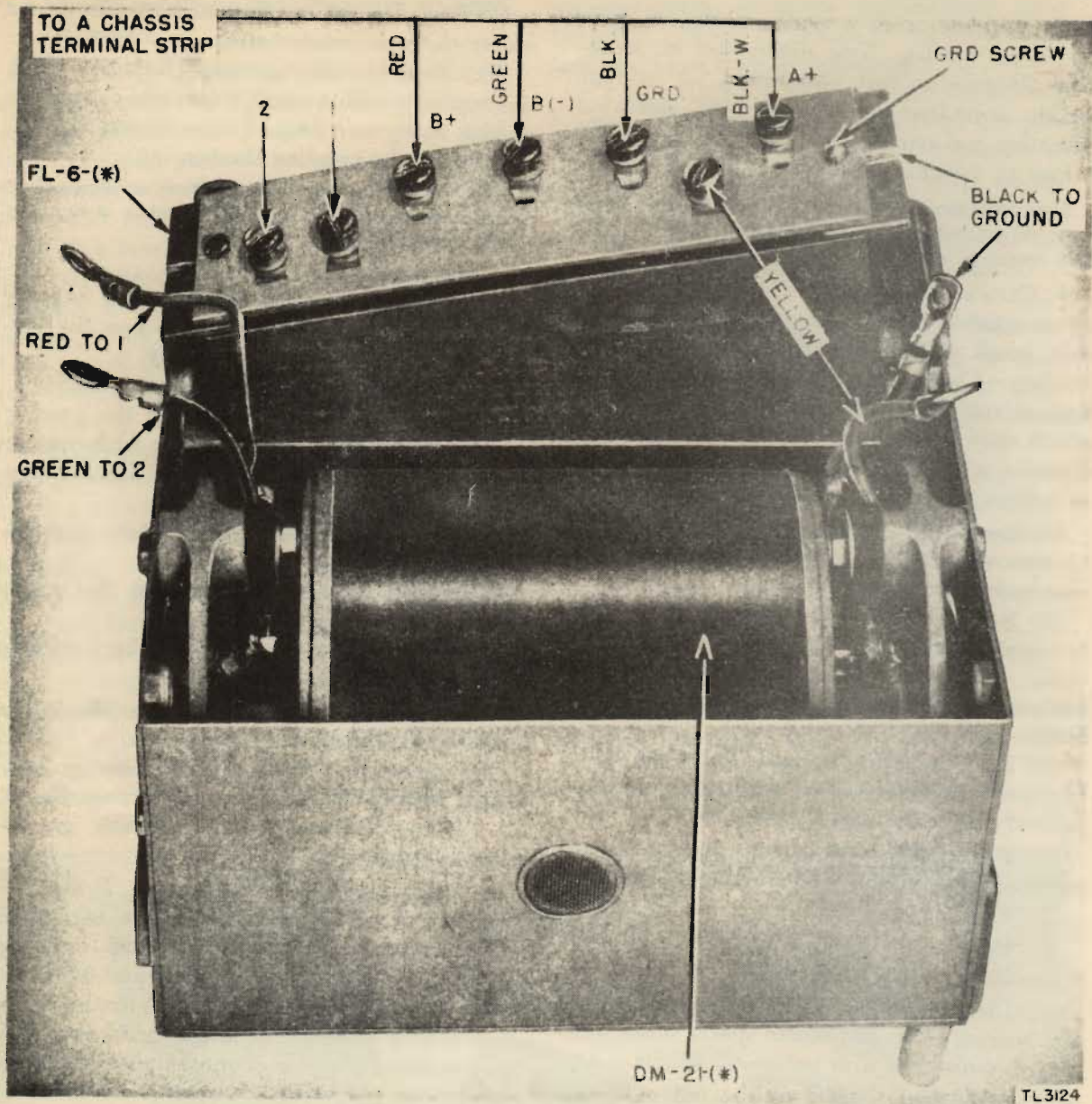

Figure 9. Filter FL-6-(*) and Dynamotor DM-21-(*).

put current. Do not remount the dynamotor in the receiver until the checks outlined in paragraph 14a have been completed.

13. Rectifier Repair

a. GENERAL. The rectifier can be tested and repaired without removing it from the receiver. Remove the two screws from the top of the chassis (fig. 13). Turn the receiver chassis up and down and remove the screw pin from the inner mounting hinge. Swing the rectifier assembly away from the panel. Discon-

nect the B+ (red) lead from pin No. 7 of the group-6 terminal board in the receiver.

b. RESISTANCE CHECK. Set the ON-OFF switch on the rectifier to the ON position. Turn the OFF-M. V. C.-A. V. C. switch of the receiver to either M. V. C. or A. V. C. position, thus closing the input circuit of the rectifier (fig. 54). The resistance measured between the two prongs of socket SO2 on the rectifier should be approximately 3 ohms. If no reading is obtained, check fuse F3 in the rectifier, and both switches mentioned above. If the

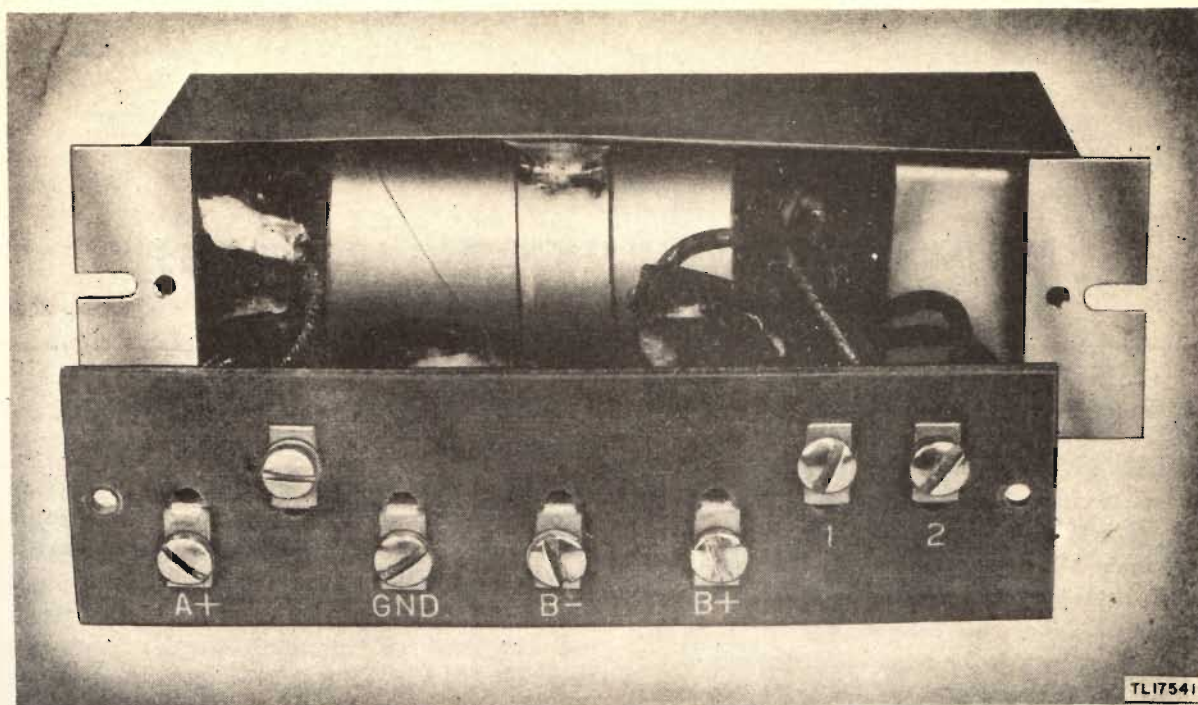

Figure 10. Filter FL-6-(*), components.

fuse and switches are not open, measure the resistance of the primary winding of transformer T3 between the terminals marked COMMON and 120 V on the rectifier terminal board. The reading should be approximately 3.6 ohms. No reading indicates an open primary winding or an open circuit in the wiring between the terminals and the winding. Make the same check between the COMMON and 110 V terminals. The reading should be approximately 3.4 ohms.

(1) When the input circuit has been found normal, check the output circuit. The resistance between the 250 V terminals should be approximately 65,000 ohms. A high resistance reading indicates an open bleeder resistor R40; a low reading indicates a shorted filter capacitor C89 or C90, or choke L35 shorted to ground.

(2) With the OFF-M. V. C.-A. V. C. switch

in the receiver in the OFF position, check the continuity of the filament and dial lamp windings of transformer T3 with an ohmmeter. Connect the ohmmeter across the terminals marked 12 V A-C for the dial lamp winding and across the terminals marked FILAMENT for the filament winding. Check the continuity of the rectifier filament winding with an ohmmeter connected across pins No. 2 and 8 of the rectifier tube socket with the tube removed.

c. VOLTAGE CHECK. Check the high-voltage output of the rectifier, using a 16,500-ohm, 25-watt resistor as a dummy load across the 250 V terminals of the rectifier terminal board. The output should be approximately 260 volts. Check the filament and dial lamp voltages. Do not reconnect the B+ lead to the group-6 terminal board until the checks outlined in paragraph 14b have been completed.

SECTION IV

PRELIMINARY TROUBLE-SHOOTING PROCEDURES

14. Input Resistance Measurements

Trouble within the receiver may often be detected by checking the resistance of the filament and high-voltage circuits at the power input terminals before applying power to the equipment, thereby preventing damage to the power supply. Make the following checks before attempting to put the receiver in operation.

a. RADIO RECEIVER BC-312-().* Leaving the dynamotor disconnected and all tubes and dial lamps removed, turn the BAND CHANGE switch to band A, the OFF-M. V. C.-A. V. C. switch to M. V. C. or A. V. C., and set the C. W.-OSC. switch at ON while making these checks.

(1) The resistance between terminals D and T, the two large pins of socket SO1, should be infinite, except in receivers containing an oscillator compartment heater. In these receivers, the resistance reading should be 4 ohms. A resistance reading in receivers which do not contain oscillator compartment heaters indicates a short circuit in the filament or dial lamp wiring which must be corrected before power is applied to the receiver.

(2) The resistance between terminal No. 7 of the group-6 terminal board (fig. 14) in the receiver and chassis should be approximately 16,500 ohms (± 10 percent). If the resistance is zero, check capacitors C50, C61, C74, and C80, and the high-voltage wiring. If the resistance is low, check for a shorted bypass capacitor in one of the plate or screen grid circuits, a short in the wiring of one of the plate or screen grid circuits, or leakage in capacitor C50, C61, C74, or C80. If the resistance is higher than normal, it indicates an open screen voltage dropping resistor. To prevent possible damage to the dynamotor, correct all abnormal

conditions before applying high voltage to the receiver.

b. RADIO RECEIVER BC-342-().* Make sure that the B+ lead from the rectifier to terminal No. 7 of the group-6 terminal board is disconnected and all tubes are removed. Disconnect the rectifier filament lead from terminal No. 5 of the group-6 terminal board. Turn the BAND CHANGE switch to band A, and the OFF-M. V. C.-A. V. C. switch to M. V. C. or A. V. C. Set the C. W.-OSC. switch at ON, and make the checks outlined in a (1) and (2) above. The checks and indications are identical for Radio Receivers BC-312-(*), and BC-342-(*).

15. Operating Test

a. PREPARATION. Insert all tubes in their proper sockets, making sure that they are fully seated. Connect the grid caps firmly. Replace the dial lamps. Make certain that terminal No. 8 of the group-6 terminal board is grounded to the chassis.

(1) In Radio Receiver BC-312-(*), replace the repaired dynamotor in the receiver and connect the dynamotor input and output leads (fig. 11). Apply the proper d-c (direct-current) voltage to terminals D and T of socket SO1.

(2) In Radio Receiver BC-342-(*), reconnect the filament lead from the repaired rectifier to terminal No. 5, and the B+ lead to terminal No. 7 of the group-6 terminal board. Depending upon the voltage for which the rectifier is set, connect 110 or 120 volts a-c to socket SO2.

b. TESTING RADIO RECEIVER BC-312-().*

(1) Turn the OFF-M. V. C.-A. V. C. switch to M. V. C. or A. V. C.

(2) Listen for crackling or buzzing noises which indicate high-voltage arcing.

(3) Check the receiver for smoke, and the odor of burned or overheated parts.

(4) Notice if the operating temperature of the dynamotor is too high. It should not be too hot to touch after it has been running for a long period of time.

(5) Measure the low-voltage input between terminals No. 1 and 6 of the group-6 terminal board. The voltage should be 12 to 14 volts d-c in Radio Receiver BC-312 to -N and 24 to 28 volts d-c in Radio Receiver BC-312-HX and -NX. If the voltage is abnormal, check the power source, filament and dial lamp wiring, and capacitors C78 and C79.

(6) The high voltage measured at terminals No. 7 and 8 of the group-6 terminal board should be 220 to 240 volts d-c. If the voltage is zero or low, check the receiver for shorted wiring and shorted or leaky capacitors.

c. TESTING RADIO RECEIVER BC-342-(*)

(1) Set the ON-OFF switch on the rectifier to the ON position.

(2) Turn the OFF-M. V. C.-A. V. C. switch to M. V. C. or A. V. C.

(3) Listen for crackling or buzzing noises which indicate high-voltage arcing.

(4) Check the receiver for smoke and the odor of burned or overheated parts.

(5) The filament voltage measured between terminals No. 5 and 6 of the group-6 terminal

board should be 12 volts a-c. If the voltage is abnormal, check the filament wiring and capacitors C78 and C79.

(6) Check the dial lamp voltage for a reading of 12 volts a-c between terminal No. 9 of the group-6 terminal board and ground. No

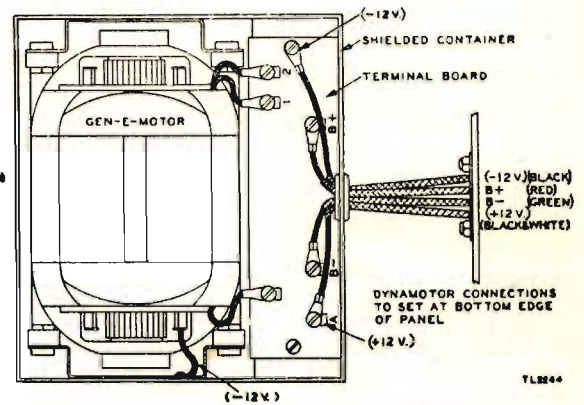

Figure 11. Dynamotor connections.

voltage indicates an open circuit between the rectifier and the terminal board.

(7) The voltage measured between terminals No. 7 and 8 of the group-6 terminal board should be approximately 260 volts d-c. If the voltage is zero or low, check for shorted wiring and shorted or leaky capacitors in the high-voltage circuits of the receiver.

SECTION V

ALIGNMENT PROCEDURE

16. Calibration of Test Equipment

To insure accuracy of alignment, use the frequency meter as a standard when setting the signal generator to a desired frequency. Check each signal generator setting against the frequency meter as follows: Place the signal generator and the frequency meter near each other. Turn both equipments on, and allow 15 minutes for them to warm up. Attach a piece of wire to the signal generator output

connection; place the wire near the frequency meter antenna. Calibrate the frequency meter according to instructions furnished with the meter. Set the frequency meter to the exact frequency at which the signal generator is to be used. While listening with the headset attached to the frequency meter, tune the generator tuning control for zero beat. Turn the frequency meter off and remove the wire attached to the signal generator output connection.

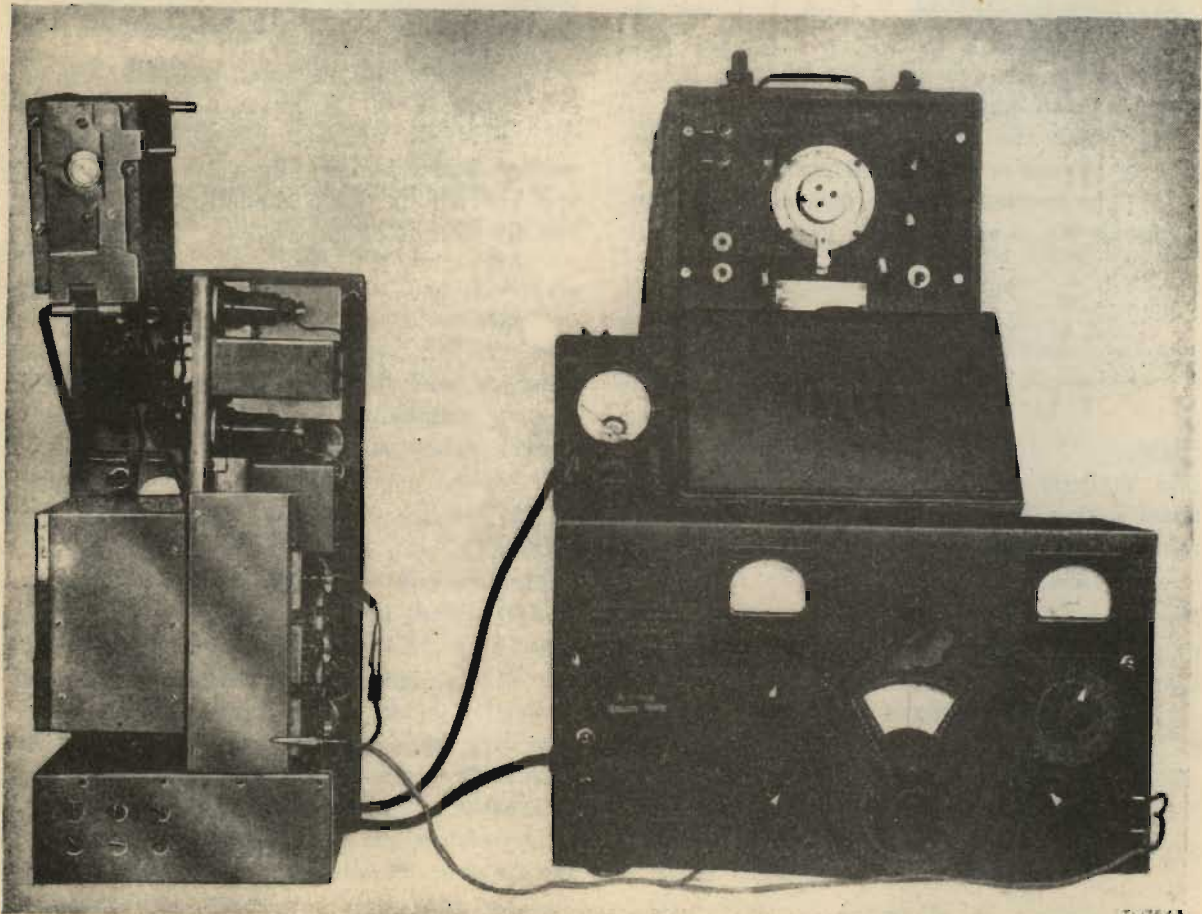

Figure 12. Radio Receiver BC-312-(*), or BC-342-(*), typical set-up for i-f alignment.

TL7543

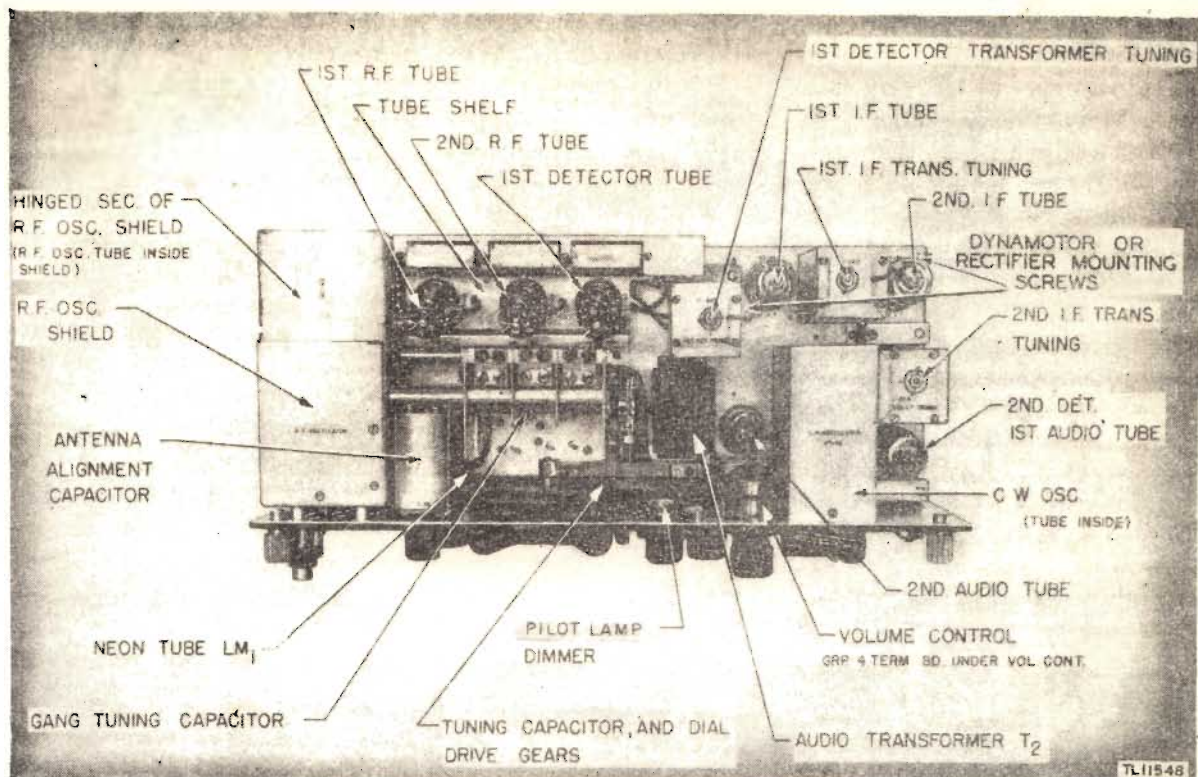

Figure 13. Receiver chassis, top view.

17. I-F Alignment

a. PREPARATION. Set up the receiver and alignment equipment (fig. 12). Calibrate the signal generator for a 470-ke signal (par. 16). Remove from the top of the chassis the two screws which hold the power supply stationary (fig. 13). Remove the screw from the dynamotor or rectifier inner mounting hinge and swing the power supply upward, securing it in position with a rack or block of wood. Set the OFF-M. V. C.-A. V. C. switch to M. V. C., the CRYSTAL PHASING control to OUT, the C. W.-OSC. switch to OFF, and the VOL. control to maximum. Loosen the i-f transformer screw locknuts.

b. PROCEDURE.

(1) Attach the signal generator ground lead to the receiver chassis and connect the dummy antenna (300-ohm resistor) between the grid cap of the second i-f amplifier tube and the output lead from the signal generator.

(2) Connect the output meter to the PHONES 2d AUDIO jack, and adjust the signal generator attenuator to give a small deflection on the output meter, using the smallest scale possible.

(3) Adjust the second i-f transformer adjustment screws (figs. 13 and 14) located on the top and bottom of the transformer for maximum output indication.

(4) Reduce the signal generator output whenever necessary during alignment to avoid overloading the receiver.

(5) Move the dummy antenna to the grid cap of the first i-f amplifier tube; adjust the first i-f transformer adjustment screws for maximum output indication.

(6) Connect the dummy antenna to the grid cap of the first detector tube; adjust the first detector transformer adjustment screws for maximum output indication.

(7) Leaving the dummy antenna connected to the first detector tube, readjust the second i-f, first i-f, and first detector transformer adjustment screws, in the order named, for maximum output.

(8) Carefully tighten the adjustment screw locknuts, avoiding any change in the settings of the screws. A change in the deflection of the output meter while a locknut is being tightened indicates that the adjustment screw has been moved and must be readjusted.

18. R-F Oscillator Alignment

a. GENERAL. Each r-f oscillator adjustment screw controls a small variable capacitor within the oscillator compartment. The rotor of each capacitor is adjustable over an arc of 360°. A red dot on one side of the screw driver slot on each adjustment screw indicates the relative position of the rotor and stator of the variable capacitor. Capacitance is at a maximum (plates fully meshed) when the red dot is beneath the slot, and at a minimum (plates completely unmeshed) when dot is above the slot. On bands A, B, and C, the r-f oscillator operates 470 kc above the frequency of a received signal; on bands D, E, and F, the r-f oscillator operates 470 kc below the frequency of a received signal. The red dots on the adjustment screws should be above the center line on bands A, B, and C, and below the center line on bands D, E, and F. The procedure outlined in the following paragraphs sets the r-f oscillator adjustments at the fundamental or proper frequency, rather than the image frequency.

b. PREPARATION. Set up the receiver and alignment equipment as shown in figure 15. Calibrate the signal generator for a 2,900-kc

signal (par. 16). Set the receiver BAND CHANGE switch on band A (1,500 to 3,000 kc), the OFF-M. V. C.-A. V. C. switch to M. V. C., the C. W.-OSC. switch at OFF, the CRYSTAL PHASING control to OUT, the VOL. control to maximum, and the receiver dial at 2,900 kc. Open the hinged cover of the r-f oscillator compartment; remove the screw caps which permit access to the r-f oscillator trimmer adjustment screws and loosen the screw locknuts.

c. PROCEDURE.

(1) Attach the signal generator ground lead to the receiver chassis and connect the 50-mmf (micromicrofarad) capacitor dummy antenna between the grid cap of the first detector tube and the output lead of the signal generator.

(2) Connect the output meter to the PHONES 2d AUDIO jack and adjust the signal generator attenuator to give a small deflection on the output meter, using the smallest scale possible.

(3) Connect a short length of insulated wire to the antenna connector of the frequency meter; insert the other end of the wire into the r-f oscillator compartment near the stator

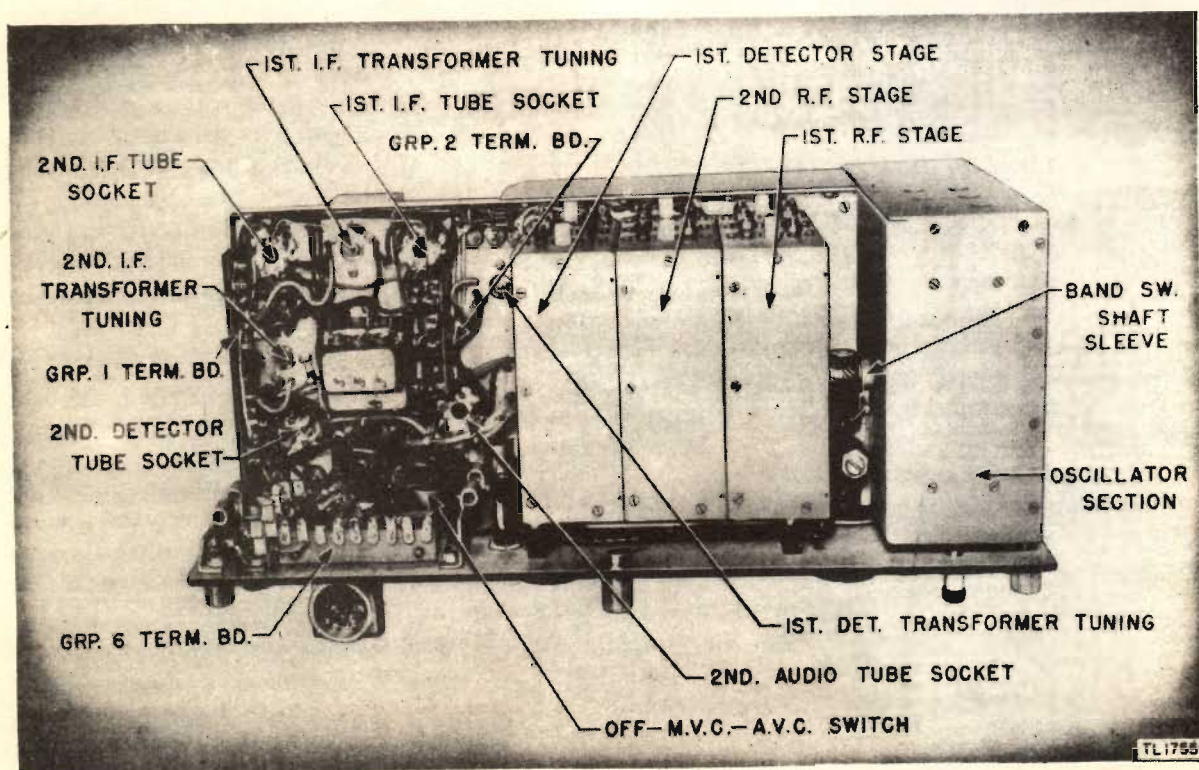

Figure 14. Receiver chassis, bottom view.

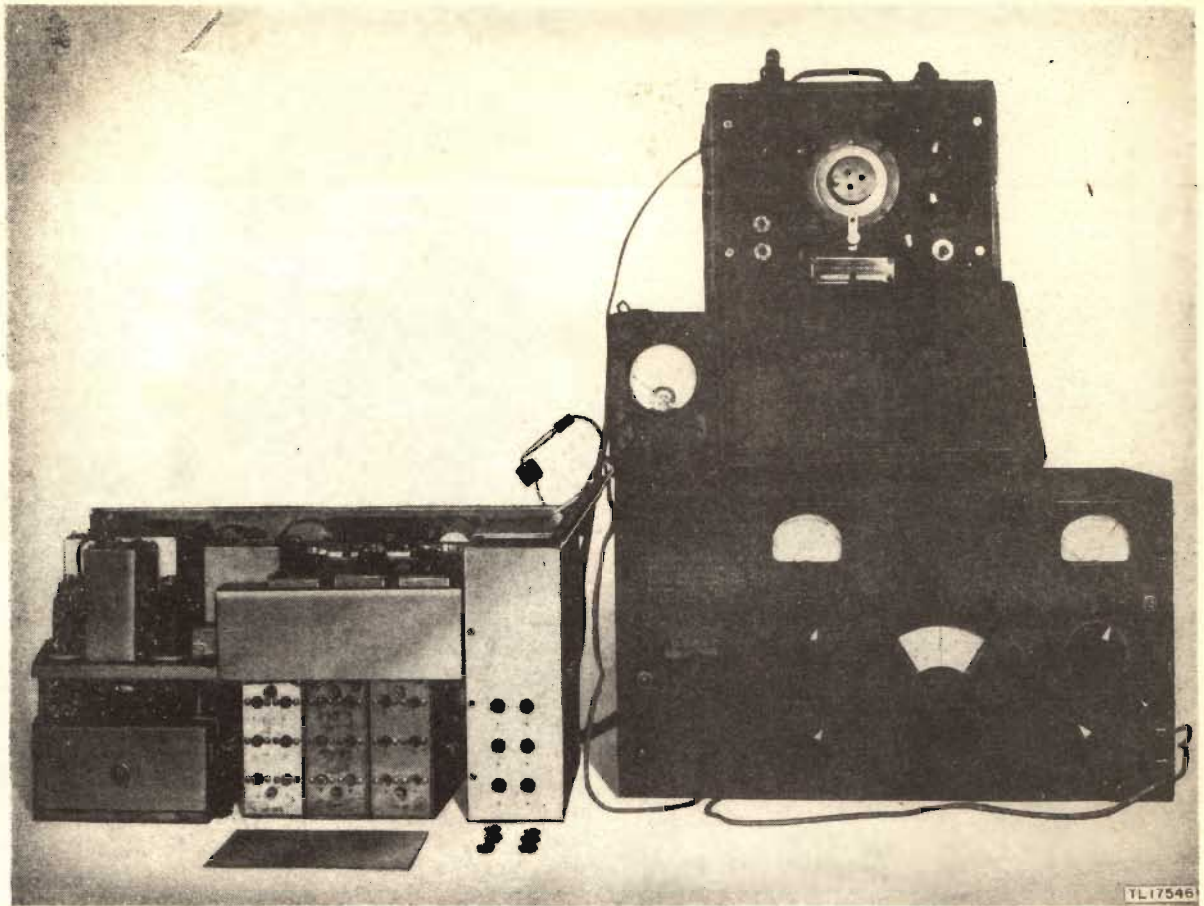

Figure 15. R-f oscillator alignment, typical set-up.

plates of the oscillator tuning capacitor. Calibrate the frequency meter for 3,370 kc.

(4) Listen to the frequency meter headset and adjust oscillator trimmer A for zero beat.

(5) Remove the wire from the oscillator compartment; close the hinged cover.

(6) Readjust trimmer A for maximum indication on the output meter, and tighten the locknut without disturbing the screw adjustment.

(7) Repeat the above procedure with each band trimmer, using the following signal generator, receiver dial, and frequency meter settings:

Band trimmer	Signal generator (kc)	Dial (kc)	Frequency meter (kc)
A.....	2,900	2,900	3,370
B.....	4,900	4,900	5,370
C.....	7,850	7,850	8,320
D.....	11,000	11,000	10,530
E.....	13,750	13,750	13,280
F.....	17,700	17,700	17,230

19. R-F and First Detector Alignment

a. GENERAL. The r-f and first detector adjustment screws, like those of the r-f oscillator, control similar small variable capacitors within the first and second r-f and the first detector compartments. The relative position of the rotor and stator of each capacitor is likewise indicated by a red dot.

b. PREPARATION. Set up the receiver and alignment equipment as shown in figure 16. Calibrate the signal generator for a 2,900-kc signal (par. 16). Set the receiver BAND CHANGE switch on band A, the OFF-M. V. C.-A. V. C. switch to M. V. C., the C. W.-OSC. switch to OFF, CRYSTAL PHASING control to OUT, the VOL. control to maximum, and the receiver dial to 2,900 kc. Remove the shield plate covering the r-f and first detector adjustment screws on the rear of the chassis; loosen the adjustment screw locknuts.

c. PROCEDURE.

(1) Attach the signal generator ground lead

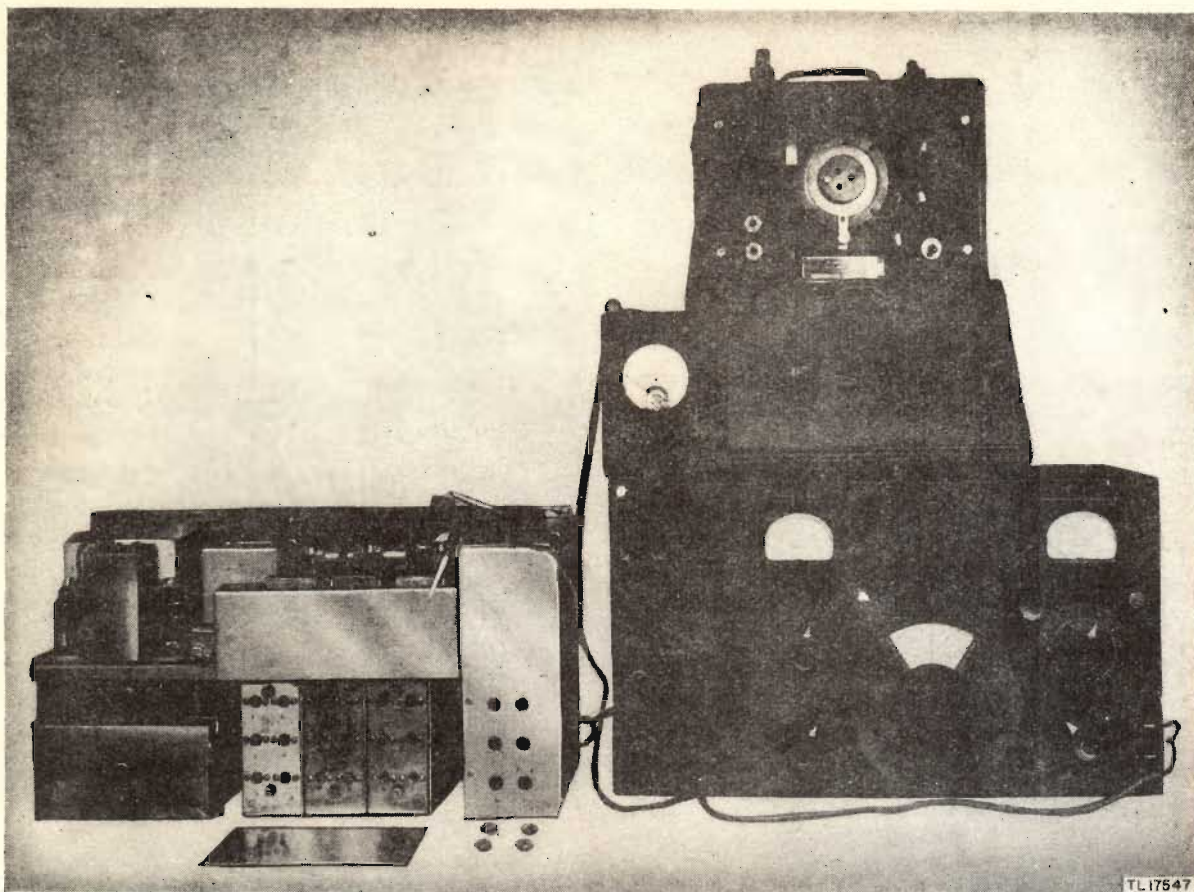

Figure 16. R-f alignment, typical set-up.

to the receiver chassis and connect the dummy antenna (50-mmf capacitor) between the grid cap of the first detector tube and the output lead of the signal generator.

(2) Connect the output meter to the PHONES 2d AUDIO jack and adjust the signal generator attenuator to give a small deflection on the output meter, using the smallest scale possible.

(3) Adjust trimmer A of the first detector stage for maximum output reading on the output meter. Reduce output from the signal generator whenever necessary to avoid overloading the receiver.

(4) Move the dummy antenna to the grid cap of the second r-f stage and adjust second r-f trimmer A for maximum output.

(5) Connect the dummy antenna to the antenna connection on the receiver front panel and set the ALIGN INPUT control to mid-position (arrow pointing straight up). Adjust first r-f trimmer A for maximum output.

(6) Tighten the locknuts on all of the A trimmer adjustment screws, avoiding any change of adjustment.

(7) Follow the same procedure and align each band, using the following trimmers and alignment frequencies:

Band trimmer	Alignment frequencies (kc)	Band trimmer	Alignment frequencies (kc)
A.....	2,900	D.....	11,000
B.....	4,900	E.....	13,750
C.....	7,850	F.....	17,700

(8) After aligning the receiver at the high-frequency end of each band, check the calibration at the low-frequency end. If the error is more than that specified in the dial deviation test (par. 38), adjust the inductance of the particular oscillator coil at fault. To make the adjustment remove the oscillator unit and adjust the single turn of wire inside the coil form. Moving the single turn into the coil decreases

the inductance, making the resonant frequency higher; moving the single turn out of the coil form increases the inductance, making the resonant frequency lower.

20. C-W Oscillator Alignment

a. PREPARATION. Set up the equipment (fig. 12). Calibrate the signal generator to 470 kc (par. 16). Set the OFF-M. V. C.-A. V. C. switch to M. V. C. or A. V. C. and the C. W.-OSC. switch to ON. Turn the CW-OSC ADJUST control so that the arrow is horizontal, pointing to the right. Remove the cap screw above the C. W.-OSC. switch, permitting access to the c-w oscillator adjustment screw. Connect a headset or speaker to the receiver.

b. PROCEDURE. With the ground lead of the signal generator connected to the receiver chassis, feed an unmodulated 470-kc signal through a 300-ohm resistor to the control grid (grid cap) of the first detector tube. Adjust the c-w oscillator adjustment screw for zero signal response in the headset or speaker. Slowly turning the CW-OSC ADJUST control 90° counterclockwise or clockwise should now produce a beat note which gradually increases in pitch; rotating the control another 90° in the same direction should gradually decrease the pitch to zero signal when the arrow is again horizontal, but pointing to the left.

21. Crystal Filter Alignment

a. PREPARATION. Set up the equipment (fig. 12). Calibrate the signal generator to 470 kc (par. 16). Set the OFF-M. V. C.-A. V. C. switch to M. V. C. and the C. W.-OSC. switch to ON. Connect a headset or speaker and the output meter to the receiver.

b. PROCEDURE.

(1) Connect the dummy antenna (300-ohm resistor) between the grid cap of the first detector tube and the output lead of the signal generator. Connect the ground lead of the signal generator to the chassis.

(2) Feed an unmodulated 470-kc signal into the receiver; rotate the CW-OSC ADJUST control until a sharp, shrill note is heard.

(3) Turn the CRYSTAL PHASING control counterclockwise (away from OUT) until a minimum or null signal response is heard. If the signal is too weak to be heard, advance the signal generator gain control until the signal is audible.

(4) Determine the operation frequency of the crystal by careful varying of the signal generator frequency slightly above and below 470 kc until a sharp increase in deflection is noted on the output meter and the volume increases noticeably in the headset or speaker. (During this procedure, it may be necessary to change the setting of the CW-OSC ADJUST control to maintain the shrill note.)

(5) Leave the signal generator set at the operation frequency of the crystal, turn the c-w oscillator off, and turn the signal generator modulation on. Repeat the i-f and first detector transformers for maximum output (par. 17). Also, realign the c-w oscillator at this new frequency (par. 20).

(6) To obtain maximum sensitivity from the receiver, it may be necessary to touch up the r-f oscillator-alignment adjustment screws, after the alignment of the crystal filter and realignment of the i-f stages.

SECTION VI

DETAILED TROUBLE-SHOOTING PROCEDURES

22. Localizing Trouble to Specific Stage

If the receiver is inoperative or has a weak output when aligned, the trouble can be quickly localized to a particular stage by signal substitution or signal tracing. Frequently an inoperative stage can be located by circuit disturbance. Turn the set on and, after the tubes have warmed up, touch a metallic object (such as a coin, key, or small screw driver) to the control grid of each tube successively, beginning with the output tube and working forward to the input tube. If a click or hum is heard in the headset or speaker, the stage is generally operative. When no response is heard, the trouble lies between the point where the click was last heard and the point of no response.

23. Checking Audio Circuit

a. TEST AND INDICATION.

(1) Set the receiver OFF-M. V. C.-A. V. C. switch to A. V. C., the C. W.-OSC. switch to OFF, the CRYSTAL PHASING control to OUT, and the VOL. control to maximum clockwise position (maximum volume).

(2) Connect a headset or speaker to the receiver.

(3) Connect the ground lead of the audio signal generator to the receiver chassis.

(4) Feed a signal from the audio signal generator through a 0.01-mf (microfarad) capacitor to the diode detector plate (pin No. 4 of

the second detector tube). A loud, clear signal will be heard if the audio circuits are functioning properly.

(5) If a weak signal or no signal is heard, feed the signal from the audio signal generator to the output, then to the input of each of the audio stages, beginning with the last stage and continuing until the defective or inoperative stage is located.

b. LOCALIZATION. If a stage is defective, refer to the paragraph covering the stage under test (sec. VIII). Trace the trouble to the defective part or parts by resistance and voltage checks.

24. Use of Stage Gain Charts

The stage gain charts list minimum and maximum input voltages required at each of the r-f and i-f stages of the receiver to produce a signal output of 10 milliwatts (equivalent to 6.3 volts across an output load of 4,000 ohms). These charts can be used as standards when trouble shooting to check the over-all gain of the receiver and the gain of each r-f or i-f stage or group of stages. When the receiver output is low, localize the defective stage by checking the signal-voltage level of each stage against the chart while using either the signal substitution or signal tracing method of trouble shooting, or by measuring the individual stage gain.

a. R-F STAGE GAIN CHARTS.

		Signal generator output connection									
		Antenna (align input control set for maximum output)	Control grid, first r-f stage		Control grid, second r-f stage		Control grid, first detector				
Band	Frequency (kc)	Signal generator output (microvolts)								Volume control setting	Output meter reading
		Min	Max	Min	Max	Min	Max	Min	Max		
A	3,000	1.5	6.0	9.0	11	11	13	70	80	(See note)	6.3
B	5,000	1.1	4.2	7.5	9.5	11	13	75	85		6.3
C	8,000	1.0	4.0	6.5	8.5	11	13	90	100		6.3
D	11,000	1.0	4.0	4.5	6.5	25	27	80	90		6.3
E	14,000	0.5	4.0	3.5	6.5	20	22	70	80		6.3
F	18,000	1.0	4.8	3.5	5.5	29	31	85	95		6.3

Note. Set VOL control to maximum and adjust signal generator output to produce a reading on output meter. Turn off modulation of signal generator and turn VOL control counterclockwise until output meter reads 3.3 volts. If the output meter reads 3.3 volts or less, with the VOL control at maximum and the modulation of the generator off, leave

the VOL control set at maximum. Turn modulation of signal generator on, and readjust generator output to produce 6.3 volts on output meter. Repeat this procedure until the output meter readings remain at 3.3 volts or less, and at 6.3 volts when the generator modulation control is repeatedly turned off and on.

b. I-f STAGE GAIN CHART.

Signal generator frequency (kc)	Signal generator output connection	Signal generator output (microvolts)		Volume control setting	Output meter reading (v)
		Min.	Max.		
470	First detector control grid	9	11	Maximum Clockwise Position	6.3
	First i-f control grid	600	700		6.3
	Second i-f control grid	11,000	13,000		6.3

25. Signal Substitution

a. TEST AND INDICATION.

(1) Set the receiver OFF-M. V. C.-A. V. C. switch to M. V. C., and the C. W.-OSC. switch to OFF, the CRYSTAL PHASING control to OUT, and the VOL. control to the position indicated in the stage gain charts.

(2) Connect a 4,000-ohm, 1-watt (± 5 percent) resistor across the 4,000-ohm secondary of transformer T2.

(3) Connect a vacuum-tube voltmeter across the 4,000-ohm resistor. (An output meter with a 4,000-ohm input impedance may be used in place of the vacuum-tube voltmeter; if so, the 4,000-ohm resistor is not used.)

(4) Using a signal generator with a measured output (that is, a microvolter or equivalent),

feed a signal of the correct frequency for the stage, with the voltage specified in the stage gain charts, to the control grid of each stage in succession. Begin with the grid of second i-f Tube JAN-6K7 (VT-86) and work forward to the receiver input.

(5) If an output of 6.3 volts cannot be obtained when a signal voltage which has a tolerance within the limits given in the chart is applied to the stage, that stage is defective.

b. LOCALIZATION. If the gain of a stage is abnormal, replace the tube and realign the stage. If the gain of that stage is still low, make a resistance and voltage check to locate the defective part. To trace the trouble to its origin, refer to the resistance and voltage

charts and to the paragraph covering the stage (sec. VIII).

26. Signal Tracing

a. TEST AND INDICATION. A signal tracer, if available, can be used to isolate a defective stage or to measure the relative stage gains of receiver r-f and i-f circuits. Proceed as follows:

(1) Set the receiver OFF-M. V. C. switch to M. V. C, the C. W.-OSC. switch to OFF, the CRYSTAL PHASING control to OUT, and VOL. control to the maximum position indicated in the stage gain charts.

(2) Connect one end of a 50-mmf capacitor to the receiver antenna terminal.

(3) Connect the signal generator (micro-volter) output lead to the other end of the 50-mmf capacitor, and connect the ground lead to the receiver chassis.

(4) Adjust the signal generator output to supply a constant signal voltage of approximately the same value noted in the antenna column of the stage gain chart.

(5) Apply signal tracer in sequence to the grids of the various stages, starting at the grid of the first r-f amplifier. Each point should indicate an increase in signal strength over the previous stage.

b. LOCALIZATION. When the gain of a stage is abnormal, follow the procedure outlined in paragraph 25b to isolate the defective part.

27. Measuring Individual Stage Gain

Stage gain is conveniently measured using a signal substitution method. In this procedure the signal generator is applied in sequence, stage by stage, starting from the r-f amplifier. If there is a defect in stage gain or improper operation of any stage, the value of the signal applied to attain an output reading of 6.3 volts will be excessive. Actual gain of a single stage is calculated as follows: The value of the signal applied to its grid to produce a 6.3-volt output is divided into the value of the signal necessary to produce the same output voltage

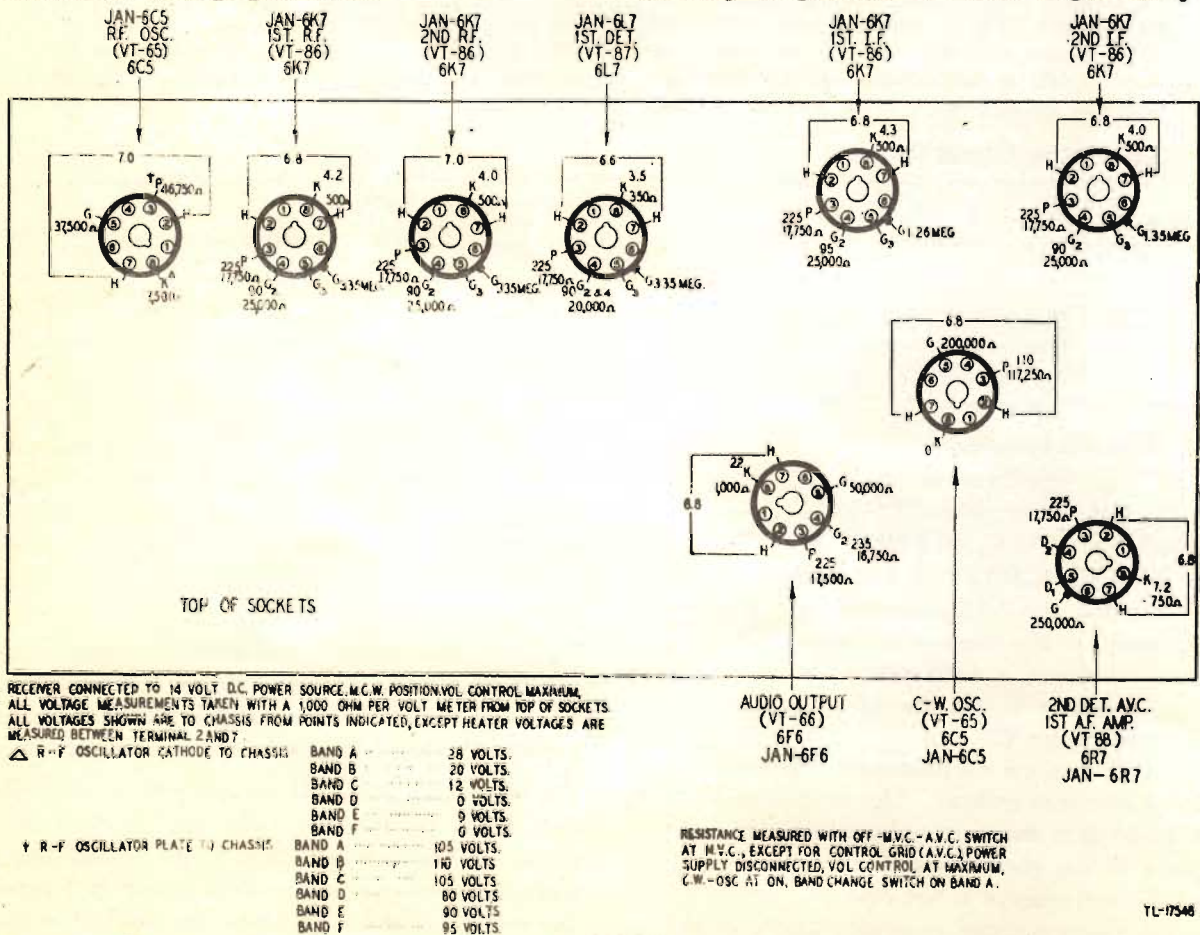

Figure 17. Radio Receiver BC-312, to -N, voltage and resistance measurements at tube sockets.

when the signal is applied to the grid of the succeeding stage.

28. Checking C-W Oscillator Operation

a. TEST AND INDICATION.

(1) Turn OFF-M. V. C.-A. V. C. switch to M. V. C., the VOL. control to its maximum clockwise position (maximum volume), the CRYSTAL PHASING control to OUT, the C. W.-OSC. switch to ON, and the CW-OSC ADJUST control so the arrow is vertical. Connect a headset or speaker to the receiver.

(2) Feed an unmodulated 10-microvolt signal (of the frequency at which the receiver dial is set) from the signal generator to the antenna terminal of the receiver.

(3) A high-pitched tone should be heard in the headset or speaker. As the CW-OSC ADJUST control is turned from a vertical position in either direction (clockwise or counterclockwise), the pitch of the tone should decrease until no signal is heard when the CW-OSC

ADJUST control arrow reaches the horizontal position.

b. LOCALIZATION. If no signal is heard at any setting of the CW-OSC ADJUST control, the stage is defective. Follow the procedure outlined in paragraph 25b to isolate the defective part. If a signal is heard but the pitch of the tone increases as the CW-OSC ADJUST control is turned either clockwise or counterclockwise from the vertical position, the c-w oscillator is not aligned properly. Realign as directed in paragraph 20.

29. Checking Crystal Filter Operation

a. TEST AND INDICATION.

(1) Turn OFF-M. V. C.-A. V. C. switch to M. V. C., the C. W.-OSC. switch to OFF, and the CRYSTAL PHASING control to OUT.

(2) Connect an antenna and a headset to the receiver and tune in a weak signal.

(3) While listening to the weak signal, turn the CRYSTAL PHASING control from the OUT position to the point of lowest background noise.

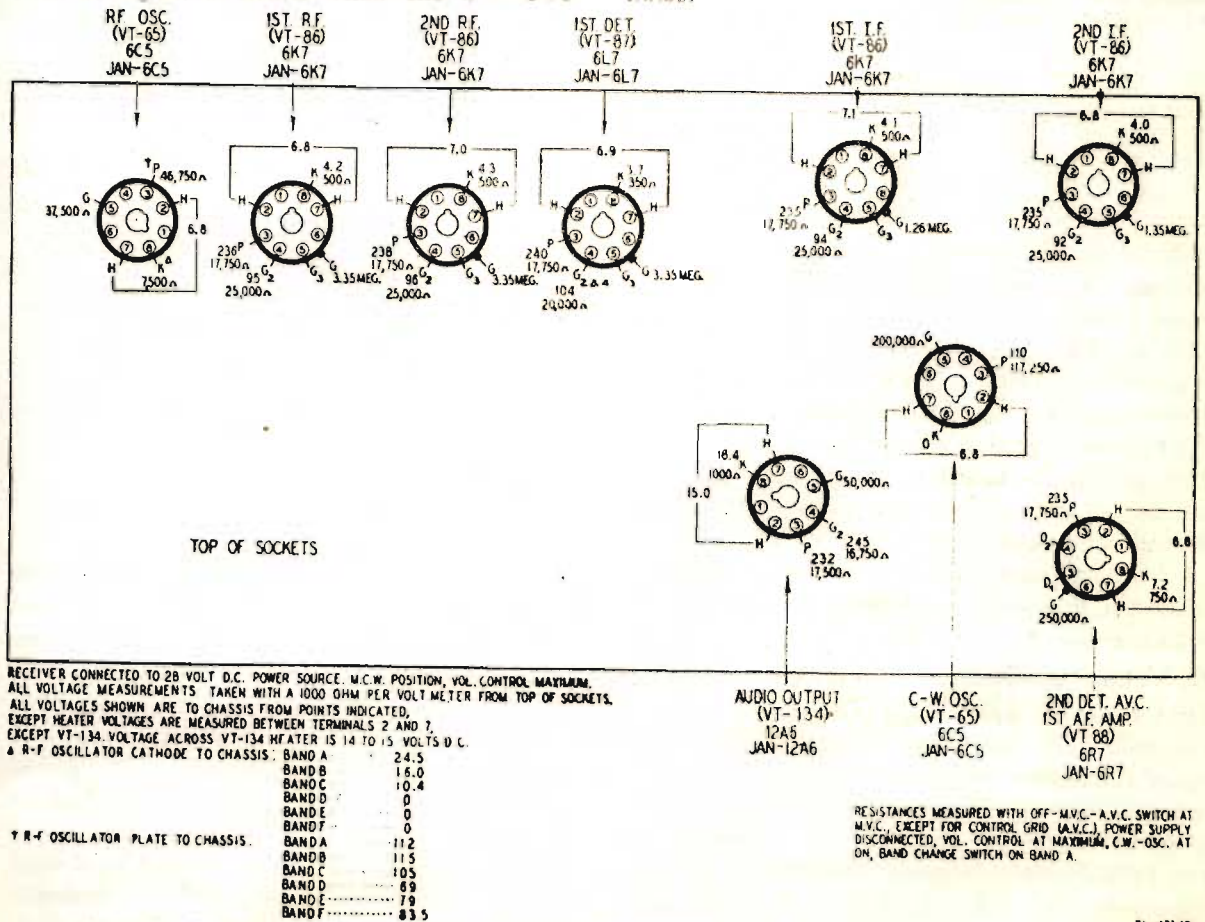

Figure 18. Radio Receivers BC-312 HX and NX, voltage and resistance measurements at tube sockets.

TL-17549

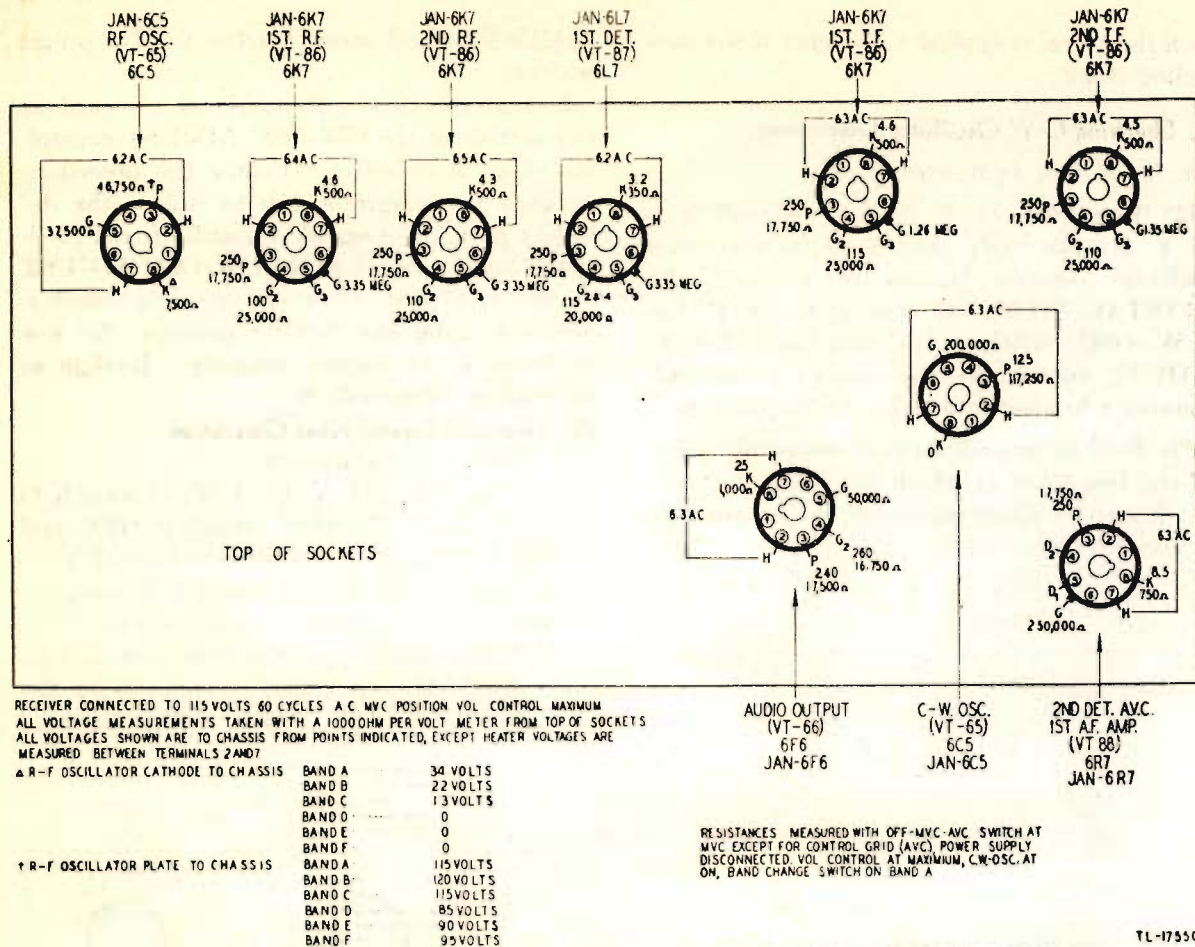

Figure 19. Radio Receiver BC-342 (*), voltage and resistance measurements at tube sockets.

(4) If the background noise level does not decrease, feed an unmodulated signal from a signal generator to the antenna of the receiver. With the CRYSTAL PHASING control arrow in a vertical position, turn the tuning dial of the receiver back and forth across the frequency at which the signal generator is set. A musical chirp should be heard in the headset; if it is not heard, either the crystal or the crystal filter circuit is defective.

b. LOCALIZATION. When no response is heard, follow the procedure outlined in paragraph 25b to locate the defective part.

30. Voltage and Resistance Measurements

Figures 17, 18, and 19 supply correct voltage and resistance measurements made from the top of the chassis with an adapter and a 1,000-ohm-per-volt voltohmmeter. When no adapter is available, use a short length of insulated wire to make voltage measurements. Strip the insulation from one end of the wire and wrap the end around the pin of the tube under test.

Insert the tube in its proper socket and measure the voltage at the other end of the wire. Avoid shorting the wire to the chassis. Measure the resistances by removing the tubes from their sockets. When measuring resistances on Radio Receiver BC-342-(*), disconnect the red wire leading from Rectifier RA-20 to terminal No. 7 of the group-6 terminal board.

31. Moistureproofing, Fungiproofing, and Refinishing

After the receiver has been repaired and is functioning correctly, refer to TB SIG 13 and TB 11-850-1; moistureproof and fungiproof the equipment as instructed. If the receiver case has been scarred or chipped, remove any rough spots with #00 or #000 sandpaper and apply paint to spots with a small brush. If the case is sufficiently scarred and scratched to warrant complete refinishing, take the chassis from the case, remove all dirt and rust with kerosene, then spray entire case in accordance with Ordnance Specification TAC ES-No. 680.

SECTION VII

FINAL TESTING

32. Alignment Check

After repairs have been completed on the receiver and the unit has been moistureproofed and fungiproofed, a final test must be made to ascertain that the unit is in proper condition for tactical use. Although the unit was correctly aligned during the repair procedure, recheck the alignment (pars. 17 to 21) after moistureproofing and fungiproofing the equipment. After the completion of the alignment check, make at least the signal-to-noise ratio test, the modulated-continuous-wave sensitivity test on M. V. C. and the Operational Test; also make such other of the following over-all

performance tests as the repairs made may indicate:

- a. Signal-to-noise ratio test (par. 33).
- b. (Modulated-continuous-wave) sensitivity test on M. V. C. and A. V. C. (par. 34).
- c. C-w sensitivity test on M. V. C. and A. V. C. (par. 35).
- d. Crystal filter sensitivity test (par. 36).
- e. Over-all selectivity test on M. V. C. and A. V. C. (par. 37).
- f. Dial deviation test (par. 38).
- g. Output overload test (par. 39).
- h. Operational test (par. 40).

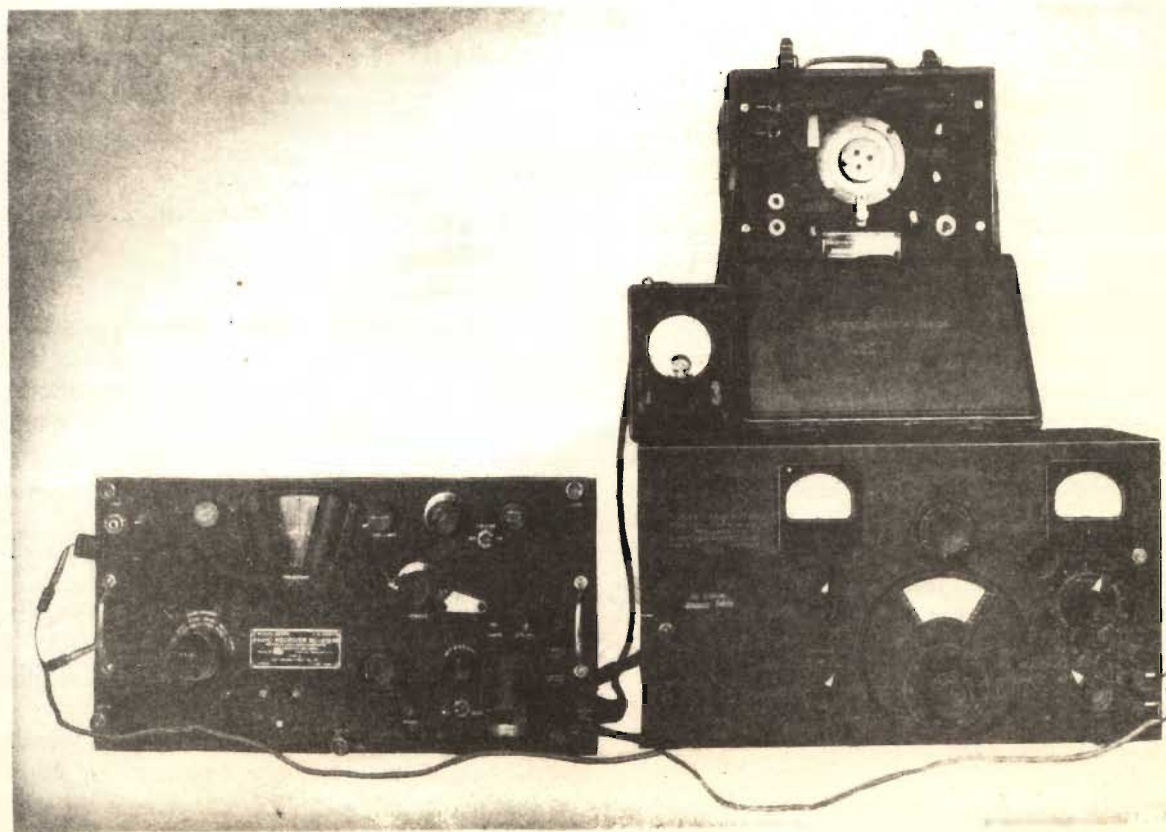

Figure 20. Final testing, typical set-up.

33. Signal-to-Noise Ratio Test

All final tests of the receiver are based upon a signal-to-noise ratio of 4/1. This ratio is established as follows:

a. PREPARATION.

(1) Set up the receiver and test equipment as shown in figure 20.

(2) Connect one lead of a 50-mmf capacitor to the receiver antenna terminal and the other lead to the output lead of the signal generator.

(3) Connect the signal generator ground lead to the receiver chassis.

(4) Connect the output meter to the SPEAKER 2D AUDIO jack. If a vacuum-tube voltmeter is used, place a 4,000-ohm non-inductive resistor across the output of transformer T2; measure the output across the resistor.

(5) Turn the receiver VOL. control to maximum, the OFF-M. V. C.-A. V. C. switch to M. V. C., the CRYSTAL PHASING control to OUT, and the C. W.-OSC. switch to OFF.

(6) Set the signal generator for 30 percent modulation at 400 cycles.

(7) Tune the signal generator and receiver to 1.5 megacycles (1500 kc).

(8) Set the ALIGN INPUT control for maximum indication on output meter.

(9) Set the signal generator output attenuator to produce a reading on the output meter.

(10) Turn off the modulation of the signal generator.

(11) Turn the VOL. control counterclockwise until the output meter reads 3.3 volts. Should the output meter read 3.3 volts or less, leave VOL. control at maximum.

(12) Turn the modulation of the signal generator on and readjust the generator output to produce 6.3 volts on output meter.

(13) Repeat steps (10), (11), and (12) until the output meter reads 3.3 volts and 6.3 volts when modulation is repeatedly turned off and on.

(14) The output meter readings of 6.3 volts and 3.3 volts represent a power ratio of 4/1.

34. M. C. W. Sensitivity Test

a. PREPARATION. Establish the signal-to-noise ratio (par. 33).

b. TEST.

(1) The m-c-w sensitivity of the receiver at 1.5 mc is the signal generator output in micro-

volts required to produce the 6.3-volt reading referred to in step (12), (par. 33), and should be within the limits shown in the m-c-w sensitivity chart (c below).

(2) Repeat steps (8) to (13) (par. 33a) for each check point frequency shown in the m-c-w sensitivity chart, and check the generator output against the limits given in the chart.

(3) When the tests have been completed for all check points, turn the OFF-M. V. C.-A. V. C. switch to A. V. C. and repeat the above procedure. The sensitivity on A. V. C. should also fall within the limits given in the chart.

c. M-C-W SENSITIVITY CHART.

Band	Frequency (mc)	Signal generator output necessary to produce output meter reading shown (microvolts)		Output meter reading
		Normal	Maximum	
A	1.5	4.0	7.5	6.3
	3.0	2.75	6.0	6.3
B	3.0	4.0	6.0	6.3
	5.0	1.6	4.1	6.3
C	5.0	2.0	4.0	6.3
	8.0	1.0	4.0	6.3
D	8.0	2.4	4.0	6.3
	11.0	2.0	4.0	6.3
E	11.0	1.0	4.0	6.3
	14.0	1.75	4.0	6.3
F	14.0	2.5	4.0	6.3
	18.0	2.0	5.0	6.3

35. C-W Sensitivity Test

a. PREPARATION.

(1) Follow the procedure given in steps (1) through (6) (par. 33a).

(2) Tune the signal generator and the receiver to the first check frequency (2.2 mc) given in the c-w sensitivity chart (c below).

(3) Set the ALIGN INPUT control for maximum indication on the output meter.

(4) Turn the signal generator modulation off.

(5) Set the C. W.-OSC. switch to ON.

b. TEST.

(1) Vary the setting of the CW-ADJUST control to produce peak reading on the output meter.

(2) Turn the generator band change switch to the band above or below the band on which it was previously set. Do not change the calibration.

(3) Adjust the VOL control to produce a reading of 3.3 volts on the output meter. Should the output meter read 3.3 volts or less, leave VOL control at maximum. This is the noise level for the test.

(4) Return the generator band change switch to the original setting (calibrated at 2.2 mc).

(5) Adjust the generator attenuation control to produce a 6.3-volt reading on the output meter.

(6) Repeat steps (2) through (5) until the output meter reads 3.3 and 6.3 volts when steps (2) and (4) are repeated several times. Do not change the VOL or attenuation control settings to secure these readings.

(7) The c-w sensitivity of the receiver at 2.2 mc is the signal generator output in microvolts required to produce the 6.3-volt reading referred to in step (6). The sensitivity should be within the limits given in the c-w sensitivity chart.

(8) Repeat the above procedure at each check frequency given in the chart.

(9) Turn the OFF-M. V. C.-A. V. C. switch to A. V. C. and repeat the test for all check frequencies. The sensitivity should remain within the limits given in the chart.

c. C-W SENSITIVITY CHART.

Band	Frequency (mc)	Signal generator output which should produce output-meter reading shown (microvolts)		Output meter reading
		Normal	Maximum	
		A.....	2.2	
B.....	4.0	1.0	3.0	6.3
C.....	6.5	1.0	3.0	6.3
D.....	9.5	1.0	3.0	6.3
E.....	12.5	1.0	3.0	6.3
F.....	16.0	1.0	3.0	6.3

36. Crystal Filter Sensitivity Test

a. PREPARATION.

(1) Follow the procedure given in steps (1) through (8) (par. 33a).

(2) Turn the signal generator modulation off.

(3) Set the CW-OSC. switch to ON.

(4) Turn the CRYSTAL PHASING control counterclockwise (away from OUT).

b. TEST.

(1) Vary the setting of the signal generator slightly above and below 1,500 kc. Two peak readings will appear on the output meter.

Caution: Leave the VOL control at maxi-

mum throughout this test. Reduce the input from signal generator to prevent possible damage to the output meter whenever the pointer threatens to go off scale.

(2) Tune the generator for maximum output indication at the frequency which produced the smaller of the two peak readings in step (1) above.

(3) Vary the setting of the CRYSTAL PHASING control to produce a minimum output indication.

(4) Retune the generator to produce a maximum output indication.

(5) Set the CW-ADJUST control to produce a peak reading on the output meter.

(6) Adjust the generator attenuator to produce a 6.3-volt reading on the output meter. The output of the generator in microvolts is the crystal sensitivity of the receiver at 1,500 kc, and should be within the limits designated in the crystal filter sensitivity chart (c below).

(7) Repeat the test at all check frequencies given in the chart and compare with the limits supplied in the chart.

c. CRYSTAL FILTER SENSITIVITY CHART.

Band	Check point frequency	Signal generator output which should produce output meter reading shown (microvolts)		Output meter reading
		Minimum	Maximum	
A.....	1,500	6.0	10.0	6.3
A.....	2,200	5.0	7.0	6.3
A.....	3,000	5.0	6.0	6.3

37. Selectivity Test

a. PREPARATION.

(1) Establish the signal-to-noise ratio (par. 33) at the first check frequency (2,000 kc) designated in the over-all selectivity chart (c below).

b. TEST.

(1) Increase the output of the signal generator to 10 times the output in microvolts required to produce the 6.3-volt reading obtained when establishing the signal-to-noise ratio in a above.

(2) Retune the generator to the frequency above the check frequency which produces an output of 6.3 volts.

(3) Retune the generator to the frequency below the check frequency which produces an output of 6.3 volts.

(4) The difference between the two frequencies obtained in steps (2) and (3) above constitute the over-all bandwidth at the check frequency. The two frequencies must fall

within the limits given in the over-all selectivity chart.

(5) Repeat the test for each check frequency given in the chart.

c. OVER-ALL SELECTIVITY CHART.

Band	Check point frequency (kc)	Signal generator frequency settings above and below check point frequencies which should produce an output meter reading of 6.3 volts		
		Normal band width (kc)	Minimum band width (kc)	Maximum band width (kc)
A	2,000	1,993-2,007	1,995-2,005	1,990-2,010
B	4,000	3,992-4,008	3,995-4,005	1,990-2,010
C	6,000	5,991-6,009	5,995-6,005	1,990-2,010
D	9,000	8,994-9,003	8,995-9,005	1,990-2,010
E	12,000	11,992-12,008	11,995-12,005	11,990-12,010
F	16,000	11,994-12,006	11,995-12,005	11,990-12,010

38. Dial Deviation Test

a. PREPARATION. Leave the equipment set up as directed in paragraph 37a (1).

b. TEST.

(1) Tune the receiver dial accurately to the first check point frequency shown in the dial deviation chart (c below).

(2) Tune the signal generator to the point where maximum output meter reading is obtained.

(3) Check the frequency reading of the signal generator, which should be within the limits shown in the chart.

(4) Repeat steps (1), (2), and (3) at each check point frequency shown in the chart.

c. DIAL DEVIATION CHART.

Band	Check point frequency (kc)	Deviation limits above and below check point frequency (kc)
A-----	1,500	15
	2,200	15
	3,000	15
B-----	3,000	15
	4,000	15
	5,000	15
C-----	5,000	15
	6,500	19.5
	8,000	24
D-----	8,000	24
	9,500	28.5
	11,000	33
E-----	11,000	33
	12,500	37.5
	14,000	42
F-----	14,000	42
	16,000	48
	18,000	54

39. Output Overload Test

a. PREPARATION. Follow the procedure given in steps (1) through (8) (par. 33a).

b. TEST.

(1) Beginning with an input of zero microvolts from the signal generator, increase the input from the generator until the first peak output indication is produced on the output meter. An approximate 150-microvolt input is required to give an output reading of approximately 69 volts.

(2) Turn the OFF-M. V. C.-A. V. C. switch to A. V. C.

(3) Increase the generator output until a new peak reading is obtained on the output meter. An 800- to 900-microvolt input is required to produce an output of approximately 70 volts.

Note. The peak reading obtained in the A. V. C. position must not differ materially from that obtained in the M. V. C. position, if the a-v-c circuit is functioning properly.

40. Operational Test

After completion of all preceding tests, give the receiver a final operational test. Place the receiver in its cabinet, fasten the screw locks, and connect one of the various types of antennas used with the receiver in the field. Check the performance of the receiver in all modes of operation on each band, using either headset or loudspeaker.

SECTION VIII

INDIVIDUAL STAGE AND CIRCUIT REPAIR DATA

41. Antenna Circuit

a. SPECIAL CIRCUIT FEATURES. The receiver antenna circuit is a conventional multi-band tuned-input circuit for the first r-f amplifier stage. It incorporates a neon lamp to protect the tuning coils against overload

which might be placed on the antenna. An antenna grounding relay, used in late models, also disables the audio circuit, and operates in conjunction with the transmitter which is used with the receiver.

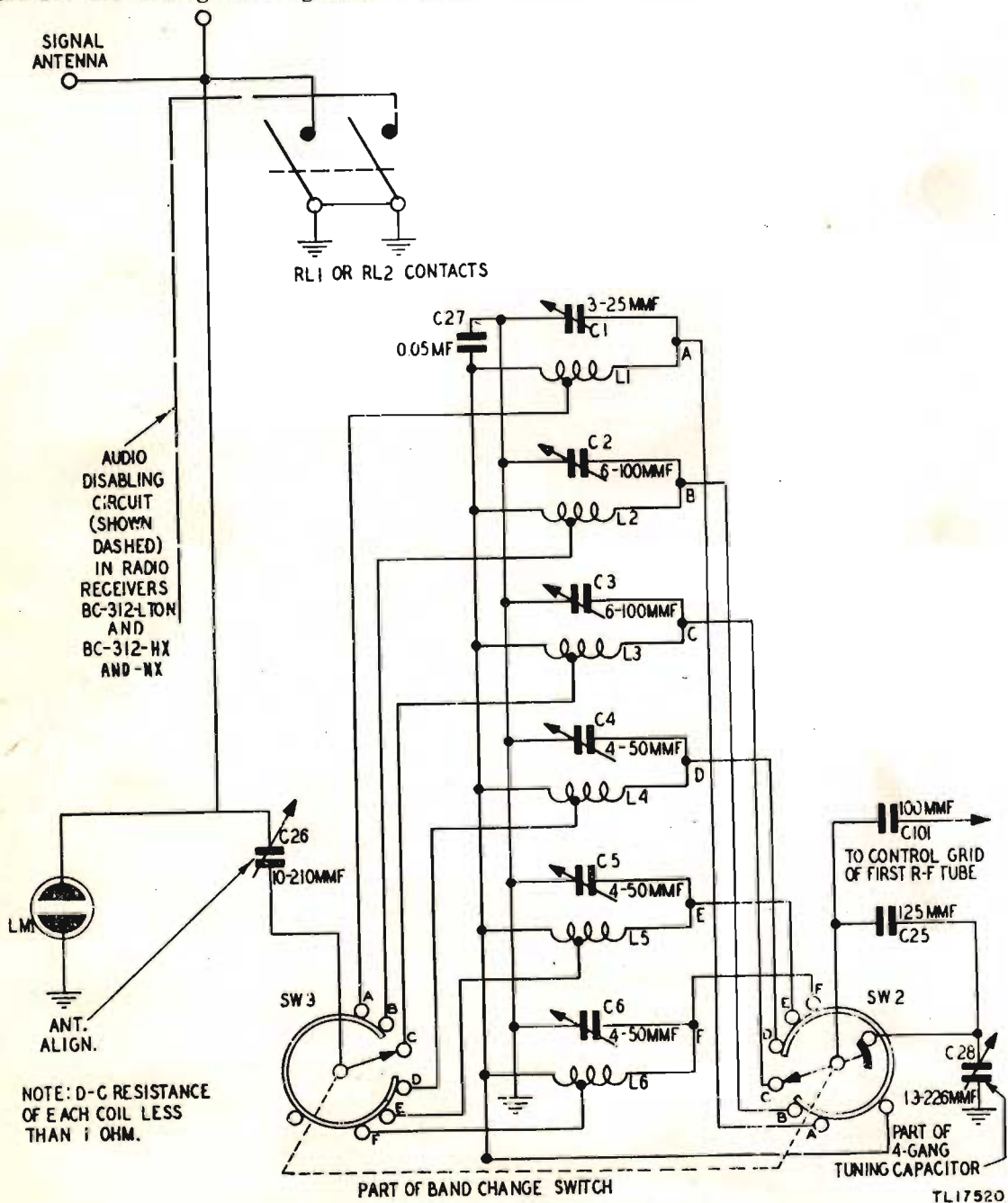

Figure 21. Antenna circuit, schematic diagram.

b. PARTS DATA.

Reference symbol	Signal Corps stock No.	Name of part and description	Function
C1	3D289	CAPACITOR, variable: air; 7 plate; 3- to 25-mmF; (part of first r-f unit assembly).	Band A, first r-f trimmer.
C2	3D291	CAPACITOR, variable: air; 27 plate; 6- to 100-mmF; (part of first r-f unit assembly).	Band B, first r-f trimmer.
C3	3D290	CAPACITOR: same as C2	Band C, first r-f trimmer.
C4		CAPACITOR, variable: air; 14 plate; 4- to 50-mmF; (part of first r-f unit assembly).	Band D, first r-f trimmer.
C5	3D294	CAPACITOR: same as C4	Band E, first r-f trimmer.
C6		CAPACITOR: same as C4	Band F, first r-f trimmer.
C25	3D293	CAPACITOR, fixed: silver mica; 125 mmF ± mmF; (part of first r-f unit).	Bands D, E, and F: first r-f padder.
C26		CAPACITOR, variable: air; 10- to 210-mmF	Antenna tuning.
C27	3D284	CAPACITOR, fixed: paper; 0.05 mf ± 10%; 400 vdcw.	First r-f bypass; balances circuit with that of other r-f stages.
C28	3D292	CAPACITOR, variable: air; 13- to 226-mmF; (one of 4 sections); (part of gang tuning capacitor).	First r-f input circuit tuning.
C101	3D266	CAPACITOR, fixed: mica; 100 mmF + 14% - 6%; 250 vdcw.	Couples tuned circuit to control grid of first r-f amplifier.
L1	3C1083	COIL: (part of first r-f unit assembly)	Band A, first r-f tuning.
L2	3C1083-3	COIL: (part of first r-f unit assembly)	Band B, first r-f tuning.
L3	3C1083-6	COIL: (part of first r-f unit assembly)	Band C, first r-f tuning.
L4	3C1083-9	COIL: (part of first r-f unit assembly)	Band D, first r-f tuning.
L5	3C1083-12	COIL: (part of first r-f unit assembly)	Band E, first r-f tuning.
L6	3C1083-15	COIL: (part of first r-f unit assembly)	Band F, first r-f tuning.
LM1	2Z5893	LAMP: neon lamp assembly	Antenna coil overload protection.
RL1		RELAY BK-13: (see power supply circuit)	Antenna and audio circuit disabling.
RL2		RELAY BK-41-A: (see power supply circuit)	Antenna and audio circuit disabling.
SW2	3Z8310-2	SWITCH: single-rotor, 6-position; ceramic-section; (part of band change switch); (part of first r-f unit assembly).	Band change; connects antenna to proper coil.
SW3		SWITCH: same as SW2	Band change; connects proper coil to tuning capacitor.
	2C4342N/A2	FIRST R-F UNIT ASSEMBLY: consists of capacitors C1 to C6, and C25, coils L1 to L6, switches SW2 and SW3, and terminal board assembly, mounted in aluminum box; (used in Radio Receivers BC-312-F, -N, -HX, and -NX and BC-342-F and -N).	
	2C4312M.1/TZ	FIRST R-F UNIT ASSEMBLY: same components as above; (used only in Radio Receivers BC-312-J, -L, and -M and BC-342-J, -L, and -M).	

c. REMOVAL AND ADJUSTMENT OF ANTENNA RELAY.

(1) Unsolder the connecting leads from antenna alignment capacitor C26; tag each lead.

(2) Detach the antenna alignment capacitor and remove it from the front panel.

(3) Remove neon lamp LM1 from its clip.

(4) Remove the relay cover by pulling it outward, then up. The relay cover clips to the relay base and requires a little pressure to remove.

(5) When the cover has been removed, readjust or replace the relay, as required.

(a) Adjust the contact clearance of Relays BK-13 and BK-41-A by loosening the locknut on the adjusting screw on top of the relay armature and, with a 1/32-inch gauge between the contacts, turn the adjusting screw until the gauge fits snugly between the contact points without bending the contact springs. When the contacts are properly adjusted, there should be between 1/64-inch and 1/32-inch space between the armature and the pole piece when the contacts are just closed. This allows for a slight wiping action between the contacts as the armature is pulled against the pole piece when the relay is energized.

(b) Replace the entire relay if the contacts or contact springs are damaged or if the coil is defective.

d. REMOVAL OF R-f TUBE SHELF.

(1) Remove the backplate of the tube shelf (eight screws).

(2) Remove the grid leads from the grid caps of the first r-f, second r-f, and first detector tubes.

(3) Remove two stud screws and two machine screws from the shelf base.

(4) Lift the shelf up and swing outward for repairs, measurements, or removal of units mounted beneath it.

(5) If it becomes necessary to remove the shelf from the chassis, unsolder the 16 leads connected to the components mounted on the shelf; tag each lead.

e. REMOVAL OF FIRST R-F UNIT ASSEMBLY.

(1) Rotate the BAND CHANGE switch to band A.

(2) Remove the setscrew from the band switch shaft coupling located between the first

r-f and r-f oscillator unit assemblies on the under side of the chassis.

(3) Remove the screw plug from the oscillator compartment shield and, using a pair of long-nose pliers, remove the band switch shaft.

(4) Remove the r-f tube shelf (d above).

(5) Remove the backplate covering the alignment screws on the first and second r-f and first detector unit assemblies.

(6) Unsolder all the wires from the top and rear of the first r-f unit. Four wires are attached to connectors which protrude through the top of the chassis: one wire connects to the antenna ALIGN INPUT control, one to the variable gang capacitor, one to the grid of the first r-f tube, and one to the chassis. There is also one connector on the rear of the unit, with a wire connecting to the a-v-c-bus. Tag all wires before removing them.

(7) Remove four flathead screws from the top of the chassis above the unit; lift out the unit.

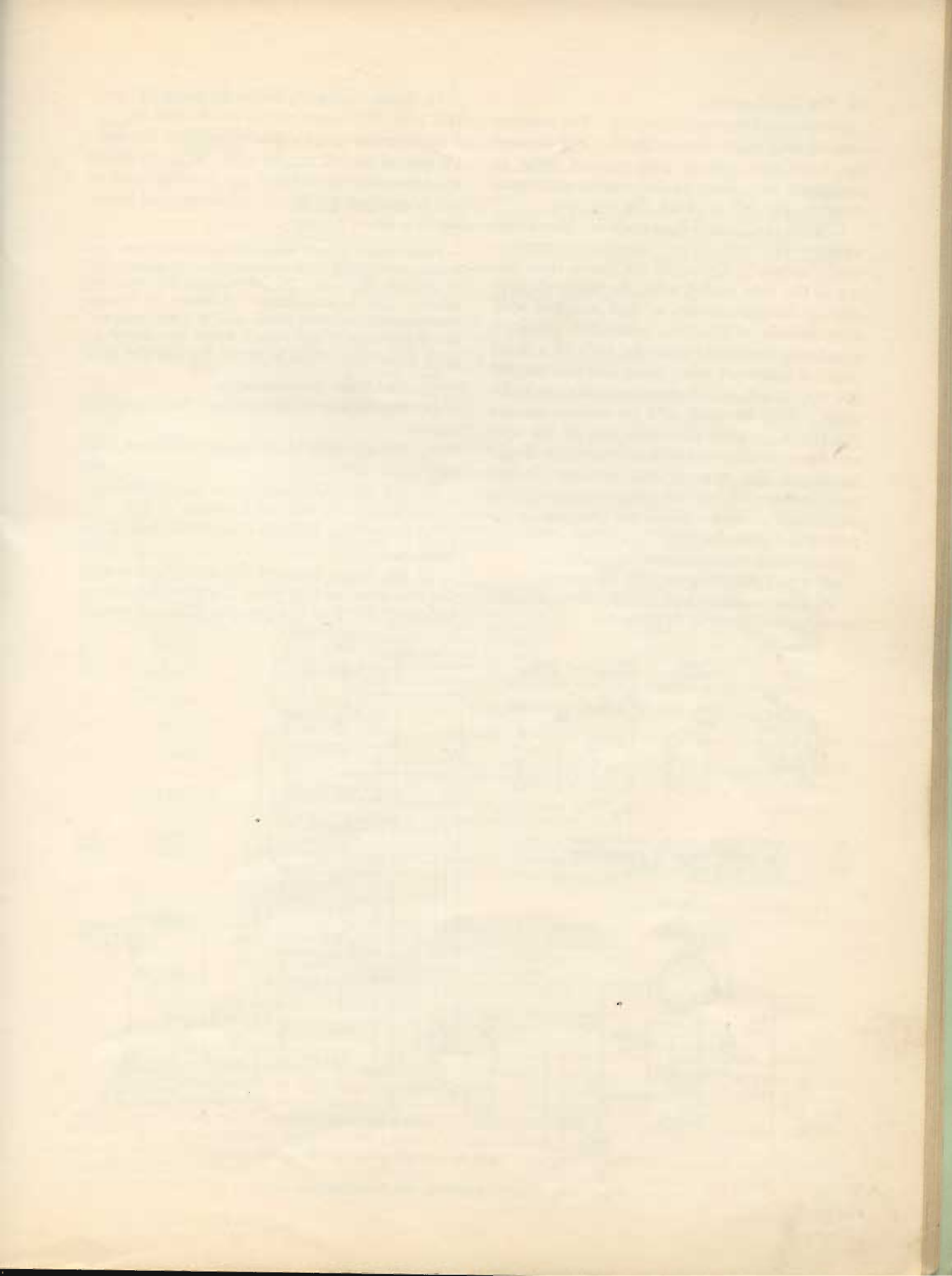

42. First R-F Amplifier

a. SPECIAL CIRCUIT FEATURES. The receiver first r-f amplifier is conventional. For data on the a-v-c and cathode bias circuits, refer to paragraph 53. Refer to the receiver schematic diagram (fig. 54) to check the B+ bus.

b. VOLTAGE AND RESISTANCE MEASUREMENTS. The voltage and resistance measurements shown in figure 22 are made from the top of the tube socket with the tubes plugged into an adapter similar to that supplied with some models of Test Set I-56-(*). When no adapter is available, strip the ends of a short piece of insulated wire; wrap one end around the tube pin at which measurements are to be made. Plug the tube into its socket; connect the meter between the other end of the wire and the chassis to obtain these readings. Avoid grounding the wire to the chassis. Before making resistance measurements remove tubes from their sockets. Make the tests under the following conditions:

(1) *Voltage measurements.*

(a) Use 1,000-ohm-per-volt voltmeter.

(b) Input voltage to Radio Receiver BC-312 to -N should be 12 to 14 volts dc.

	RADIO RECEIVER BC-312 TO N		RADIO RECEIVER BC-312-HX AND -NX		RADIO RECEIVER BC-342-(*)	
TERMI-NAL	VOLTS	TERMI-NAL	VOLTS	TERMI-NAL	VOLTS	TERMI-NAL
2	A	2	A	2	A	
3	225	3	236	3	250	
4	90	4	95	4	100	
7	A	7	A	7	A	
8	4.2	8	4.2	8	4.2	

TOP OF SOCKET

NOTE: A - HEATER VOLTAGE MEASURED BETWEEN TERMINALS 2 AND 7. THE VOLTAGE SHOULD BE APPROXIMATELY 6.8-7 VOLTS FOR ALL TUBES.

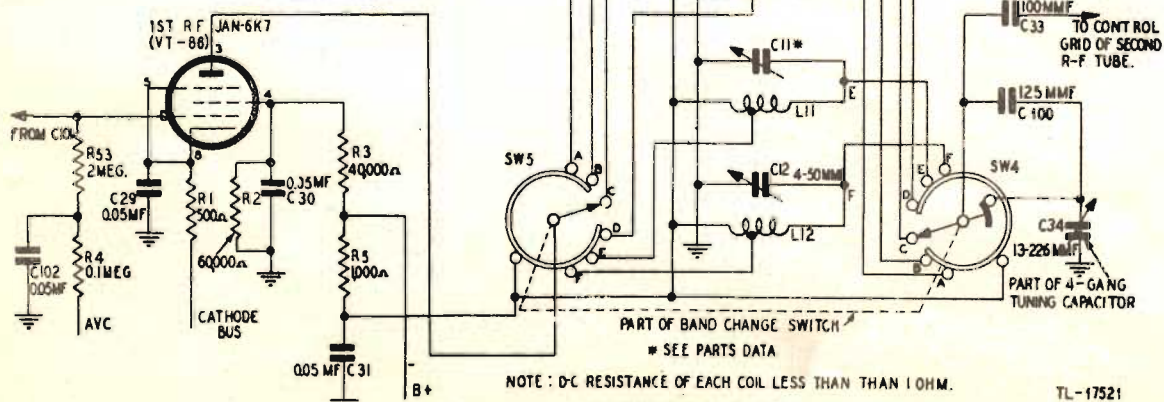

Figure 22. First r-f amplifier, schematic diagram.

(c) Input voltage to Radio Receiver BC-312-HX and -NX should be 24 to 28 volts dc.

(d) Input voltage to Radio Receiver BC-342-(*) should be 110 or 120 volts, 50 to 60 cycles ac, depending upon which tap is being used on the primary of the power transformer of Rectifier RA-20.

Note. The voltage measurements given are not critical, and considerable variation may be encountered in different receivers. Socket voltages will vary depending upon input voltages. However, if voltages vary greatly from those listed, trouble is indicated and the components in the circuit under test should be given a resistance check to isolate the defective part.

(2) *Resistance measurements.*

(a) Disconnect input voltage from the receiver.

(b) Set the OFF-M. V. C.-A. V. C. switch at OFF.

(c) Set the VOL. control at maximum.

(d) Set the C. W.-OSC. switch at ON.

(e) Turn the BAND CHANGE switch to band A.

(f) On Radio Receiver BC-342-(*), unsolder the red wire leading from Rectifier RA-20 to terminal No. 7 of the group-6 terminal board.

c. PARTS DATA.

Reference symbol	Signal Corps stock No.	Name of part and description	Function
C7	3D289	CAPACITOR, variable: air; 7 plate; 3- to 25-mmF; (part of second r-f unit assembly).	Band A, second r-f trimmer.
C8	3D291	CAPACITOR, variable: air; 27 plate; 6- to 100-mmF; (part of second r-f unit assembly).	Band B, second r-f trimmer.
C9		CAPACITOR: same as C8.	Band C, second r-f trimmer.
C10	3D290	CAPACITOR, variable: air; 14 plate; 4- to 50-mmF; (part of second r-f unit assembly).	Band D, second r-f trimmer.
C11		CAPACITOR: same as C10 in Radio Receivers BC-312 to BC-312-G, -N, -HX and -NX to -H and -N.	Band E, second r-f trimmer.
C12		CAPACITOR: same as C7 in Radio Receivers BC-312-J to -M, and BC-342-J to -M.	
C29	3D195	CAPACITOR: same as C10	Band F, second r-f trimmer.
C30		CAPACITOR, fixed: paper; 3-section, each 0.05 mf, +14%-6%; 300 vdw.	Cathode r-f bypass.
C31		CAPACITOR: same as C29	Screen r-f bypass.
C32	3D284	CAPACITOR, fixed: paper; 0.05 mf $\pm 10\%$; 400 vdw.	B+ supply r-f bypass; combines with R5 to form a filter to prevent interstage coupling.
C33	3D266	CAPACITOR, fixed: mica; 100 mmf +4% -6%; 250 vdw.	Plate r-f bypass.
C34	3D292	CAPACITOR, variable: air; 13- to 226-mmF; one of 4 sections; (part of gang tuning capacitor).	Couples tuned input circuit to control grid of second r-f tube.
C100	3D294	CAPACITOR, fixed: silver mica; 125 mmf ± 1 mmf; (part of second r-f unit assembly).	Second r-f input circuit tuning.
C102		CAPACITOR: same as C32	Bands D, E, and F; second r-f padder.
L7	3C1083-1	COIL: (part of second r-f unit assembly)	Combines with R4 to form an a-v-c filter for r-f.
L8	3C1083-4	COIL: (part of second r-f unit assembly)	Band A, second r-f tuning.
L9	3C1083-7	COIL: (part of second r-f unit assembly)	Band B, second r-f tuning.
L10	3C1083-10	COIL: (part of second r-f unit assembly)	Band C, second r-f tuning.
L11	3C1083-13	COIL: (part of second r-f unit assembly)	Band D, second r-f tuning.
L12	3C1083-16	COIL: (part of second r-f unit assembly)	Band E, second r-f tuning.
R1	3Z4564	RESISTOR, fixed: wire-wound; 500 ohms $\pm 10\%$; 1-w.	Band F, second r-f tuning.
R2	3Z4569	RESISTOR, fixed: composition; 60,000 ohms $\pm 10\%$; 1/2-w.	Cathode bias.
R3	3Z4549	RESISTOR, fixed: composition; 40,000 ohms $\pm 10\%$; 1/2-w.	Screen voltage bleeder.
R4	3Z4572	RESISTOR, fixed: composition; 100,000 ohms $\pm 10\%$; 1/3-w.	Screen voltage divider.
R5	3Z4567	RESISTOR, fixed: composition; 1,000 ohms $\pm 10\%$; 1/3-w; (used in Radio Receivers BC-312, BC-312-A, and BC-342).	Part of a-v-c filter (see C102).
	3Z4525	RESISTOR, fixed: composition; 1,000 ohms $\pm 10\%$; 1/2-w; (used in all except Radio Receivers BC-312, BC-312-A, and BC-342).	Part of B+ supply r-f filter (see C31).
R53	3Z4573	RESISTOR, fixed: composition; 2 meg $\pm 10\%$; 1/3-w.	
SW4	3Z8310-2	SWITCH: single-rotor, 6-position; ceramic-section; (part of band change switch); (part of second r-f unit assembly).	First r-f tube control grid load.
SW5		SWITCH: same as SW4	Band change; connects correct coil to tuning capacitor.
	2C4342N/A3	SECOND R-F UNIT ASSEMBLY: consists of capacitors C7 to C12, and C100, coils L7 to L12, switches SW4 and SW5, and terminal board assembly; mounted in aluminum box; (used in Radio Receivers BC-312-F, -N, -HX, and -NX BC-342-F and -N).	Band change; connects first r-f plate circuit to correct coil
	2C4312M.1/T3	SECOND R-F UNIT ASSEMBLY: same components as above; (used only in Radio Receivers BC-312-J, -L, -M, BC-342-J, -L, and -M).	

d. REMOVAL OF SECOND R-F UNIT ASSEMBLY.

(1) Follow the procedure outlined in paragraph 41e (1) through (5).

(2) Unsolder all wires from the top and rear of the unit. Four wires are attached to connectors which protrude through the top of the chassis; one wire connects to the variable gang capacitor, one to the chassis, one to the grid of

the second r-f tube, and one to the plate of the first r-f tube. There are also two connectors on the rear of the unit to which are connected the a-v-c bus and the high-voltage supply. Tag all wires when removing them.

(3) Remove the four flathead screws from the top of the chassis above the unit; lift out the unit.

43. Second R-F Amplifier

a. SPECIAL CIRCUIT FEATURES. The receiver second r-f amplifier is conventional. For data on the a-v-c and cathode bias circuits, refer to paragraph 53. Refer to the receiver schematic diagram (fig. 54) to check the B+ bus.

b. VOLTAGE AND RESISTANCE MEASUREMENTS. The voltage and resistance measurements shown in figure 23 are made in the manner and under the conditions listed in paragraph 42b.

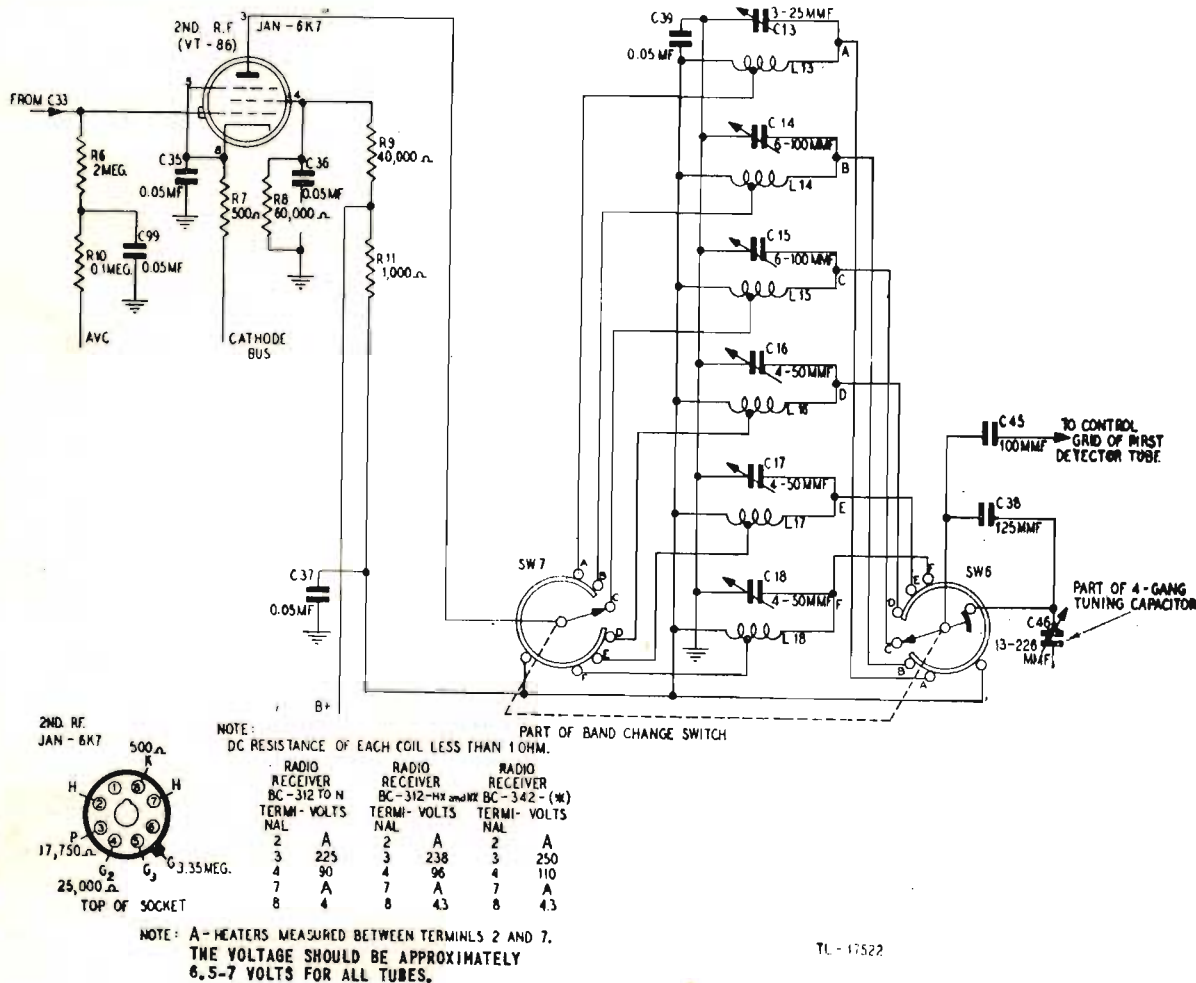

Figure 23. Second r-f amplifier, schematic diagram.

c. PARTS DATA.

Reference symbol	Signal Corps stock No.	Name of part and description	Function
C13	3D289	CAPACITOR, variable: air; 7-plate; 3- to 25-mmf; (part of first detector unit assembly).	Band A, first detector trimmer.
C14	3D291	CAPACITOR, variable: air; 27-plate; 6- to 100-mmf; (part of first detector unit assembly).	Band B, first detector trimmer.
C15		CAPACITOR: same as C14	Band C, first detector trimmer.
C16	3D290	CAPACITOR, variable: air; 14-plate; 4- to 50-mmf; (part of first detector unit assembly).	Band D, first detector trimmer.
C17		CAPACITOR: same as C16	Band E, first detector trimmer.
C18		CAPACITOR: same as C16	Band F, first detector trimmer.
C35	3D195	CAPACITOR, fixed: paper; 3-section, each 0.05 mf + 14%, -6%; 300 vdw.	Cathode r-f bypass.

c. PARTS DATA.—Continued.

Reference symbol	Signal Corps stock No.	Name of part and description	Function
C36 C37		CAPACITOR: same as C35. CAPACITOR: same as C35.	Screen r-f bypass. B+ supply r-f bypass, combines with R11 to form filter to prevent interstage coupling.
C38	3D294	CAPACITOR, fixed: silver mica; 125 mmf \pm 1 mmf; (part of first detector unit assembly).	Bands D, E, and F; first detector paddler.
C39	3D284	CAPACITOR, fixed: paper; 0.05 mf \pm 10%; 400 vdw.	Plate r-f bypass.
C45	3D266	CAPACITOR, fixed: mica; 100 mmf \pm 14%, -6%; 250 vdw.	Couples tuned input circuit to control grid of first detector tube.
C46	3D292	CAPACITOR, variable: air; 13- to 226-mmf; one of 4 sections; (part of gang tuning capacitor).	First detector input circuit tuning.
C99		CAPACITOR: same as C39.	Combines with R10 to form an a-v-c filter for r-f.
L13	3C390	COIL: (part of first detector unit assembly)	Band A, first detector tuning.
L14	3C390-1	COIL: (part of first detector unit assembly)	Band B, first detector tuning.
L15	3C390-2	COIL: (part of first detector unit assembly)	Band C, first detector tuning.
L16	3C390-3	COIL: (part of first detector unit assembly)	Band D, first detector tuning.
L17	3C390-4	COIL: (part of first detector unit assembly)	Band E, first detector tuning.
L18	3C390-5	COIL: (part of first detector unit assembly)	Band F, first detector tuning.
R6	3Z4573	RESISTOR, fixed: composition; 2 meg \pm 10%; 1/3-w.	Second r-f tube control grid load.
R7	3Z4564	RESISTOR, fixed: wire-wound; 500 ohms \pm 10%; 1-w.	Cathode bias.
R8	3Z4569	RESISTOR, fixed: composition; 60,000 ohms \pm 10%; 1/2-w.	Screen-voltage bleeder.
R9	3Z4549	RESISTOR, fixed: composition; 40,000 ohms \pm 10%; 1/2-w.	Screen-voltage bleeder.
R10	3Z4572	RESISTOR, fixed: composition; 100,000 ohms \pm 10%; 1/3-w.	Part of a-v-c filter (see C99).
R11	3Z4567	RESISTOR, fixed: composition; 1,000 ohms \pm 10%; 1/3-w (used in Radio Receivers BC-312, BC-312-A, and BC-342).	Part of B+ supply r-f filter (see C37).
	3Z4525	RESISTOR, fixed: composition; 1,000 ohms \pm 10%; 1/2-w (used in all except Radio Receivers BC-312, BC-312-A, and BC-342).	
SW6	3Z8310-2	SWITCH; single-rotor, 6-position; ceramic-section; (part of band change switch).	Band change; couples correct coil to tuning capacitor.
SW7		SWITCH: same as SW6.	Band change; couples second r-f plate circuit to correct coil.
	2C4342N/A1	FIRST DETECTOR UNIT ASSEMBLY: consists of capacitors C13 to C18, and C38, coils L13 to L18, switches SW6 and SW7, and terminal board assembly; mounted in aluminum box; (used in Radio Receivers BC-312-F, -N, -HX, 2nd -NX, BC-342-F, and -N).	
	2C4312M.1/T4	SECOND R-F UNIT ASSEMBLY: same components as above; (used in Radio Receivers BC-312-J, -L, -M, BC-342-J, -L, and -M).	

d. REMOVAL OF FIRST DETECTOR UNIT ASSEMBLY.

(1) Follow the procedure outlined in paragraph 41e (1) through (5).

(2) Unsolder all wires from the top and rear of the unit. Four wires are attached to connectors which protrude through the top of the chassis: one wire connects to the variable gang capacitor, one to the chassis, one to the grid of

the first detector tube, and one to the plate of the second r-f tube. There are also two connectors on the rear of the unit to which are connected the a-v-c bus and the high-voltage supply. Tag all wires before removing them.

(3) From the top of the chassis, remove the four flathead screws above the unit; lift out the unit.

44. R-F Oscillator

a. SPECIAL CIRCUIT FEATURES. The receiver r-f oscillator circuit is a modified Hartley circuit with the r-f output taken from the cathode. Refer to the receiver schematic diagram (fig. 54) to check the B+ bus.

b. VOLTAGE AND RESISTANCE MEASUREMENTS. The voltage and resistance measurements shown in figure 24 are made in the manner and under the conditions listed in paragraph 42b.

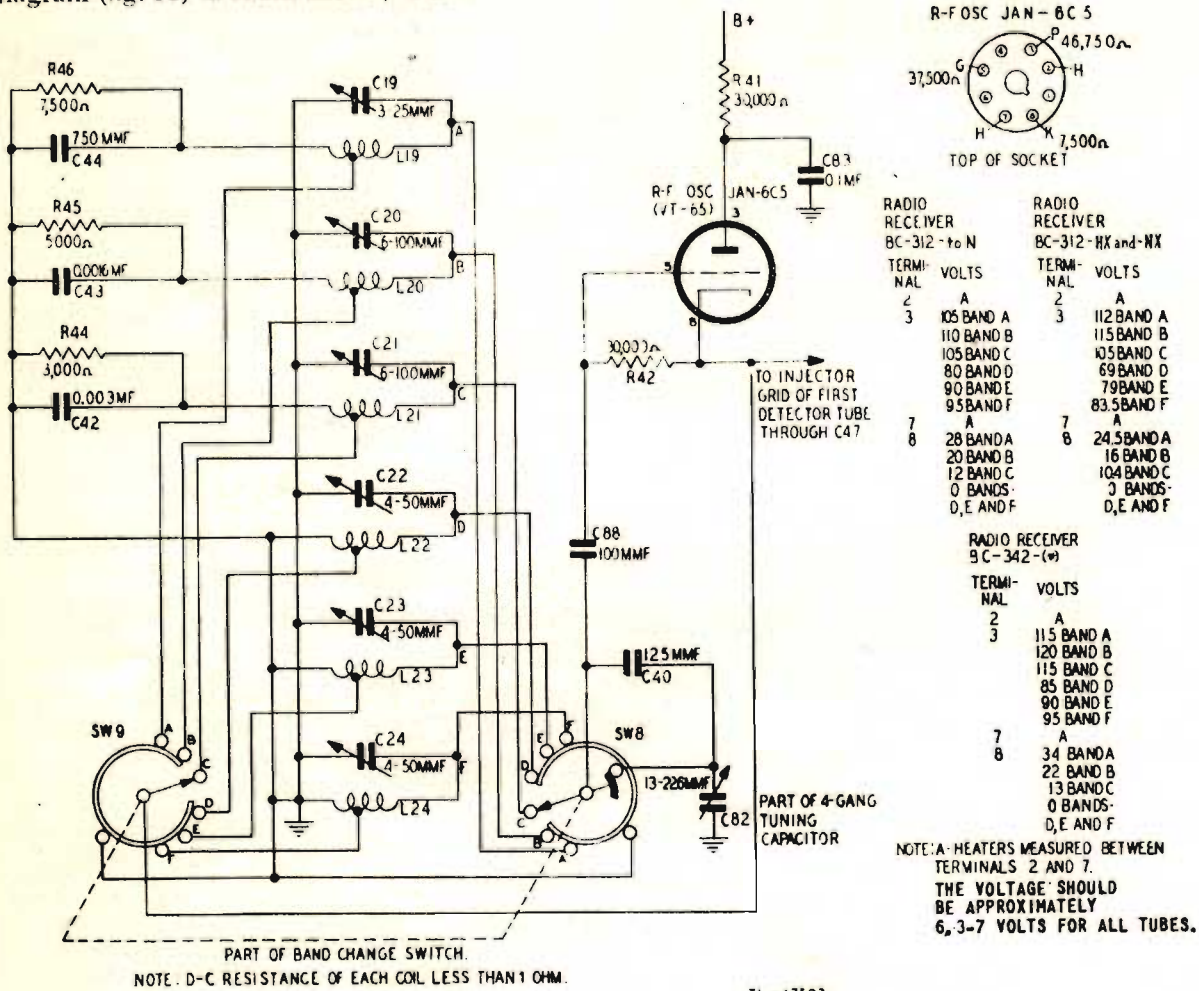

Figure 24. R-f oscillator, schematic diagram.

c. PARTS DATA.

Reference symbol	Signal Corps stock No.	Name of part and description	Function
C19	3D289	CAPACITOR, variable: air; 7-plate; 3- to 25-mmuf; (part of r-f oscillator unit assembly).	Band A, r-f oscillator trimmer.
C20	3D291	CAPACITOR, variable: air; 27-plate; 6 to 100-mmuf; (part of r-f oscillator unit assembly).	Band B, r-f oscillator trimmer.
C21		CAPACITOR: same as C20	Band C, r-f oscillator trimmer.
C22	3D290	CAPACITOR, variable: air; 14-plate; 4-to 50-mmuf; (part of r-f oscillator unit assembly).	Band D, r-f oscillator trimmer.
C23		CAPACITOR: same as C22	Band E, r-f oscillator trimmer.
C24		CAPACITOR: same as C22	Band F, r-f oscillator trimmer.
C40	3D284	CAPACITOR, fixed: paper; 0.05 mf $\pm 10\%$; 400 vdcw.	Bands D, E, and F; r-f oscillator padder.
C42	3D300	CAPACITOR, fixed: silver mica; 3,000 mmf $\pm 2\%$; 250 vdcw.	Band C, r-f oscillator padder.

c. PARTS DATA—Continued.

Reference symbol	Signal Corps stock No.	Name of part and description	Function
C43	3D297	CAPACITOR, fixed: silver mica; 1,600 mmf $\pm 2\%$; 250 vdw.	Band B, r-f oscillator padder.
C44	3D299	CAPACITOR, fixed: silver mica; 750 mmf $\pm 2\%$; 250 vdw.	Band A, r-f oscillator padder.
C82	3D282	CAPACITOR, variable: air; 13- to 226-mmF; one of 4 sections; (part of gang tuning capacitor).	R-f oscillator tuning.
C83	3D277	CAPACITOR, fixed: paper; 0.1 mf $\pm 10\%$; 400 vdw.	Plate r-f bypass; returns plate r-f circuit to ground.
C88	3D266	CAPACITOR, fixed: mica; 100 mmf $+14\% - 6\%$; 250 vdw.	Couples r-f oscillator grid circuit through switch SW8 to tank circuit.
L19	3C1083-2	COIL: (part of r-f oscillator unit assembly)	Band A, r-f oscillator tank inductance.
L20	3C1083-5	COIL: (part of r-f oscillator unit assembly)	Band B, r-f oscillator tank inductance.
L21	3C1083-8	COIL: (part of r-f oscillator unit assembly)	Band C, r-f oscillator tank inductance.
L22	3C1083-11	COIL: (part of r-f oscillator unit assembly)	Band D, r-f oscillator tank inductance.
L23	3C1083-14	COIL: (part of r-f oscillator unit assembly)	Band E, r-f oscillator tank inductance.
L24	3C1083-17	COIL: (part of r-f oscillator unit assembly)	Band F, r-f oscillator tank inductance.
R41	3Z4539	RESISTOR, fixed: composition; 30,000 ohms $\pm 10\%$; 1-w.	Plate voltage dropping.
R42	3Z4540	RESISTOR, fixed: composition; 30,000 ohms $\pm 10\%$; 1/2-w.	R-f oscillator grid leak and bias.
R44	3Z4527	RESISTOR, fixed: composition; 3,000 ohms $\pm 10\%$; 1/2-w; (used in Radio Receivers BC-312, BC-312-A, and BC-342).	Band C, cathode bias.
	3Z4635	RESISTOR, fixed: composition; 3,000 ohms $\pm 10\%$; 1-w; (used in all except Radio Receivers BC-312, BC-312-A, and BC-342).	
R45	3Z4528	RESISTOR, fixed: composition; 5,000 ohms $\pm 10\%$; 1/2-w; (used in Radio Receivers BC-312, BC-312-A, and BC-342).	Band B, cathode bias.
	3Z4637	RESISTOR, fixed: composition; 5,000 ohms $\pm 10\%$; 1-w; (used in all except Radio Receivers BC-312, BC-312-A, and BC-342).	
R46	3Z4577	RESISTOR, fixed: composition; 7,500 ohms $\pm 10\%$; 1/2-w; (used in Radio Receivers BC-312, BC-312-A, and BC-342).	Band A, cathode bias.
	3Z4638	RESISTOR, fixed: composition; 7,500 ohms $\pm 10\%$; 1-w; (used in all except Radio Receivers BC-312, BC-312-A, and BC-342).	
SW8	3Z8310-2	SWITCH: single-rotor; 6-position; ceramic-section: (part of band change switch); (part of r-f oscillator unit assembly).	Band change; couples r-f oscillator grid circuit to correct tank circuit.
SW9		SWITCH: same as SW8	Band change; couples r-f oscillator cathode circuit to correct tank circuit.
	2C4342N/A4	R-F OSCILLATOR UNIT ASSEMBLY: consists of capacitors C19 to C24, coils L19 to L24, switches SW8 and SW9, and two terminal board assemblies; mounted in aluminum box; (used in Radio Receivers BC-312-F, -N, -HX, and -NX, BC-342-F, and -N).	
	2C4312M.1/T5	R-F OSCILLATOR UNIT ASSEMBLY: same components as above; (used only in Radio Receivers BC-312-J, -L, -M, BC-342-L, and -M).	

d. REMOVAL OF R-F OSCILLATOR UNIT ASSEMBLY.

(1) Rotate the BAND CHANGE switch to band A.

(2) Remove the r-f oscillator compartment cover (21 screws).

(3) Remove the shaft-locking setscrew which extends through the band switch shaft between the first r-f amplifier and the r-f oscillator units on the under side of the chassis.

(4) Using long-nose pliers, pull the shaft out through the r-f oscillator unit.

(5) Unsolder and remove the four leads attached to the top of the terminal board which is just below the socket of r-f oscillator Tube JAN-6C5 (VT-65).

(6) Remove the four flathead machine screws which attach the unit to the receiver chassis. These screws are located on the bottom of the chassis.

45. First Detector

a. **SPECIAL CIRCUIT FEATURES.** The receiver first detector circuit is conventional. However, three different methods of coupling the output of the detector tube to the input of the first i-f amplifier tube are used in various models of the receiver. The most prevalent method is that utilizing the crystal filter circuit. This circuit is used in all models of Radio Receiver BC-342-(*) and most models of Radio Receiver BC-312-(*). The three methods (fig.

25) are designated according to the model in which each is used. For data on the a-v-c circuit, see paragraph 53. Refer to the receiver schematic diagram (fig. 54) to check the B+ bus.

b. **VOLTAGE AND RESISTANCE MEASUREMENTS.** The voltage and resistance measurements shown in figure 25 are made in the manner and under the conditions listed in paragraph 42b.

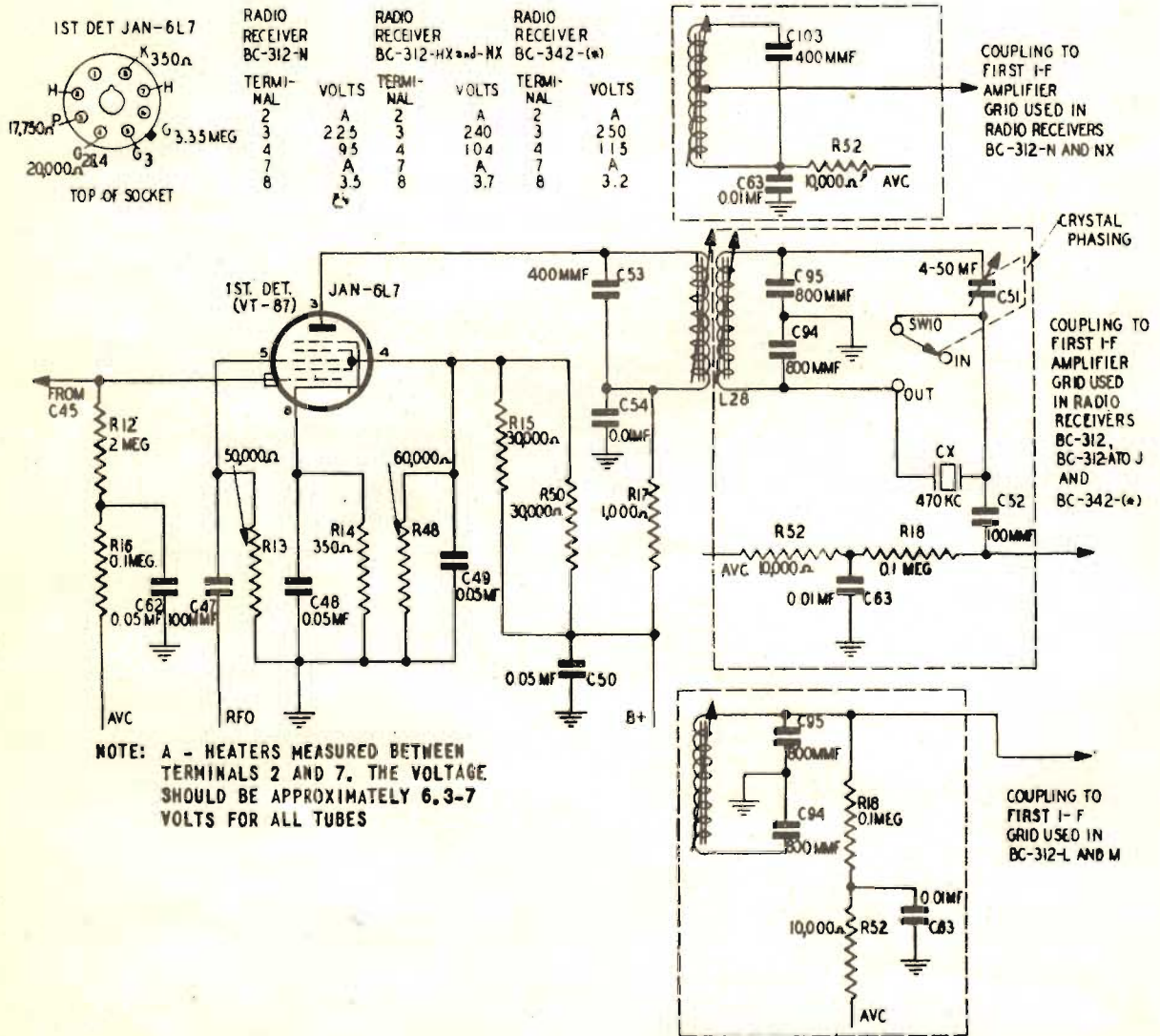

Figure 25. First detector, schematic diagram.

TL-17524

c. PARTS DATA.

Reference symbol	Signal Corps stock No.	Name of part and description	Function
C47	3D266	CAPACITOR, fixed: mica; 100 mmf $\pm 14\%$ - 6% ; 250 vdw.	Couples r-f oscillator output to injector grid of first detector tube.
C48	3D195	CAPACITOR, fixed: paper; 3-section, each 0.05 mf $\pm 14\%$ - 6% ; 300 vdw.	Cathode r-f bypass.
C49		CAPACITOR: same as C48.	Screen r-f bypass.
C50		CAPACITOR: same as C48.	B+ supply r-f bypass; combines with R1 forming filter to prevent interstage coupling.
C51	3D323	CAPACITOR, variable: air; 4- to 50-mmf; (part of first detector transformer assembly in Radio Receivers BC-312 to -J, -HX, and BC-342-(*).	Crystal phasing; balances out crystal capacitance.
C52	3D266	CAPACITOR, fixed: mica; 100 mmf $\pm 14\%$ - 6% ; 250 vdw; (used only in Radio Receivers BC-312, BC-312-A, and BC-342).	Couples output of first detector tube to first i-f amplifier.
	3D342	CAPACITOR, fixed: mica; 100 mmf $\pm 2\%$; 400 vdw; (used in Radio Receivers BC-312-C to -J, -HX, and BC-342-A to -N).	
C53		CAPACITOR (part of first detector transformer assembly).	First detector transformer primary tuning.
	3D296	Fixed: mica; 400 mmf $\pm 2\%$; 250 vdw; (used in Radio Receivers BC-312, BC-312-A, and BC-342).	
	3D344	Fixed: silver mica; 400 mmf $\pm 2\%$; 400 vdw; (used in all except Radio Receivers BC-312, BC-312-A, and BC-342).	
C54		CAPACITOR (part of first detector transformer assembly).	First detector plate r-f bypass.
	3D281	Fixed: paper; 0.01 mf $\pm 10\%$; 400 vdw; (used in Radio Receivers BC-312-A, -N, -NX, BC-342, and BC-342-N).	
	3D371	Fixed: mica; 0.01 mf $\pm 10\%$; 450 vdw; (used in all except Radio Receivers BC-312, BC-312-A, -N, -NX, BC-342, and BC-342-N).	
C62	3D284	CAPACITOR, fixed: paper; 0.05 mf $\pm 10\%$; 400 vdw.	Combines with R16 to form an a-v-c filter for r-f for first detector tube.
C63		CAPACITOR: same as C54 except in Radio Receiver BC-342.	Combines with R52 to form an a-v-c filter for r-f for first i-f amplifier.
C63	3D296	CAPACITOR, fixed: mica; 400 mmf $\pm 2\%$; 250 vdw; (used only in Radio Receiver BC-342).	
C94, C95	3D298	CAPACITOR, fixed: silver mica; 800 mmf $\pm 2\%$; 250 vdw; (part of first detector transformer assembly); (used in all except Radio Receivers BC-312-N and -NX).	First detector transformer secondary tuning.
C103	3D344	CAPACITOR, fixed: silver mica; 400 mmf $\pm 2\%$; 400 vdw; (part of first detector transformer assembly); (used only in Radio Receiver BC-312-N and -NX).	First detector transformer secondary tuning.
CX	2Z3501 6	CRYSTAL: quartz; 470-ke; (part of first detector transformer assembly); (used in Radio Receivers BC-312 and BC-312-A).	Crystal filter.
	2Z3501-6A	CRYSTAL: same as above, but used only in Radio Receivers BC-312-C to -J and -HX.	
L28	2Z9882.1	FIRST DETECTOR TRANSFORMER ASSEMBLY: permeability-tuned; 470-ke coils, crystal filter circuit, capacitors, resistors, and switch mounted in aluminum shield; (used in Radio Receivers BC-312, to -J, and -HX).	Couples first detector output to input of first i-f amplifier.
	2Z9947 412	FIRST DETECTOR TRANSFORMER ASSEMBLY: permeability-tuned; 470-ke coils, capacitors, and resistors mounted in aluminum shield; (used in Radio Receivers BC-312 L and -M).	
	2Z9940 412	FIRST DETECTOR TRANSFORMER ASSEMBLY: permeability-tuned; 470-ke coils, capacitors, and resistors mounted in aluminum shield; (used in Radio Receivers BC-312-M and -NX).	
R12	3Z4573	RESISTOR, fixed: composition; 2-meg $\pm 10\%$; 1/3-w.	Control grid load for first detector tube.

c. PARTS DATA—Continued.

Reference symbol	Signal Corps stock No.	Name of part and description	Function
R13	3Z4568	RESISTOR, fixed: composition, 50,000 ohms $\pm 10\%$; 1/3-w.	Injector grid load for first detector tube.
R14	3Z4566	RESISTOR, fixed: wire-wound; 350 ohms $\pm 10\%$; 1-w.	Cathode bias.
R15	3Z4540	RESISTOR, fixed: composition; 30,000 ohms $\pm 10\%$; 1/2-w.	Combines with R50 to form screen voltage divider.
R16	3Z4572	RESISTOR, fixed: composition; 100,000 ohms $\pm 10\%$; 1/3-w.	Part of a-v-c r-f filter (see C62).
R17	3Z4525	RESISTOR, fixed: composition; 1,000 ohms $\pm 10\%$; 1/2-w; (part of first detector transformer assembly).	Part of B+ supply r-f filter (see C50).
R18	3Z4572	RESISTOR, fixed: composition; 100,000 ohms $\pm 10\%$; 1/3-w; (part of first detector transformer assembly); (not used in Radio Receivers BC-312 N and -NX).	Grid load for first i-f amplifier.
R48	3Z4569	RESISTOR, fixed: composition; 60,000 ohms $\pm 10\%$; 1/2-w.	Screen bleeder.
R50		RESISTOR: same as R15	Part of screen voltage divider (see R15).
R52	3Z4575	RESISTOR, fixed: composition; 10,000 ohms $\pm 10\%$; 1/3-w; (part of first detector transformer assembly).	Part of a-v-c r-f filter (see C63).
SW10	See C51	SWITCH: (ganged to C51); (not used in Radio Receivers BC-312-I to -N and -NX)	Switches crystal in and out of circuit.

d. REMOVAL OF FIRST DETECTOR TRANSFORMER.

- (1) Remove the dynamotor or rectifier as directed in paragraph 9.
- (2) From the under side of the chassis, re-

move the screws which support the transformer
 (3) Disconnect the four leads to the transformer, tagging each lead before it is unsoldered.

- (4) Lift the transformer out of chassis

Faint, illegible text at the top of the page, possibly a header or title.



Faint, illegible text at the bottom of the page, possibly a footer or concluding remarks.

46. First I-F Amplifier

a. SPECIAL CIRCUIT FEATURES. The first i-f amplifier circuit is conventional. Data on the a-v-c and cathode circuits are given in paragraph 53. Refer to the receiver schematic (fig. 54) to check the B+ bus.

b. VOLTAGE AND RESISTANCE MEASUREMENTS. The voltage and resistance measurements shown in figure 26 are made in the manner and under the conditions listed in paragraph 42b.

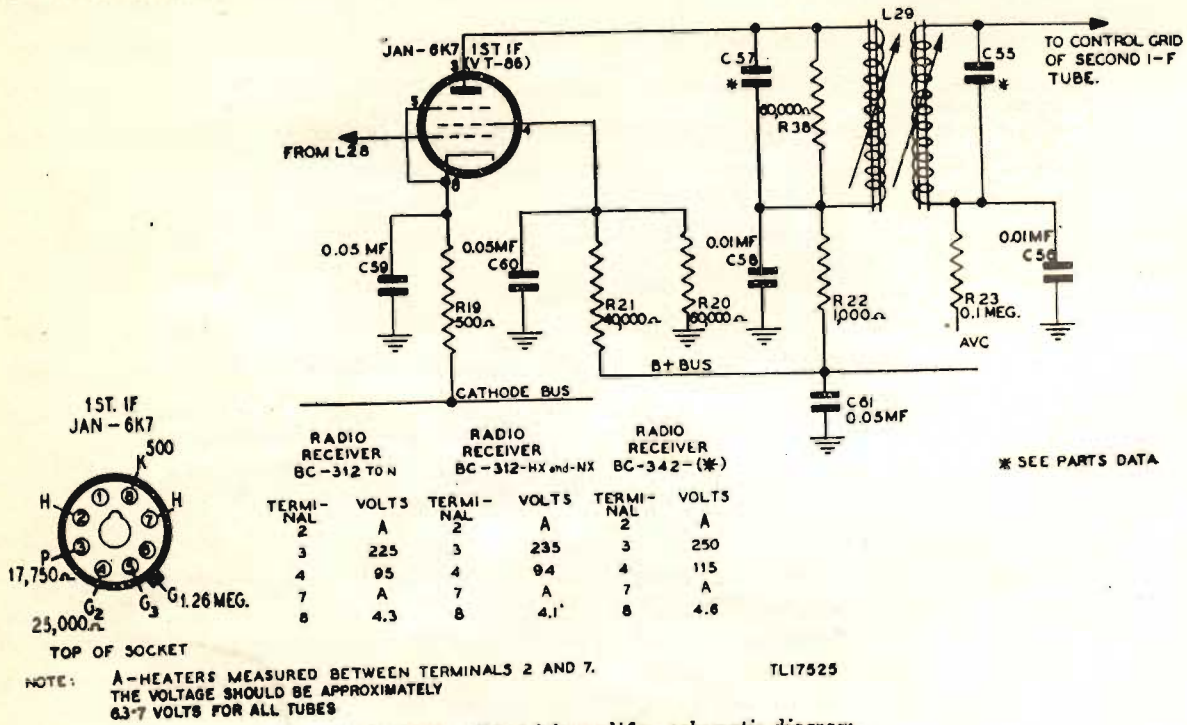

Figure 26. First i-f amplifier, schematic diagram.

c. PARTS DATA.

Reference symbol	Signal Corps stock No.	Name of part and description	Function
C55	3D295 3D344	CAPACITOR (part of first i-f transformer assembly). Fixed: mica; 50 mmf $\pm 2\%$; 300 vdcw; (used in Radio Receivers BC-312, BC-312-A, and BC-342). Fixed: silver mica; 400 mmf $\pm 2\%$; 400 vdcw; (used in all except Radio Receivers BC-312, BC-312-A, and BC-342).	First i-f transformer secondary tuning.
C56	3D281 3D371	CAPACITOR, (part of first transformer assembly). Fixed: paper; 0.01 mf $\pm 10\%$; 400 vdcw; (used in Radio Receivers BC-312, BC-312-A, -N, -NX, BC-342, and BC-342-N). Fixed: mica; 0.01 mf $\pm 10\%$; 450 vdcw; (used in all except Radio Receivers BC-312, BC-312-A, -N, -NX, BC-342, and BC-342-N).	Combines with R23 to form an a-v-c filter for r-f.
C57		CAPACITOR: same as C55.	First i-f transformer primary tuning.
C58		CAPACITOR: same as C56.	Plate r-f bypass.
C59	3D302	CAPACITOR, fixed: paper; 3-section, each 0.05 mf $+14\%$, -6% ; 300 vdcw.	Cathode r-f bypass.
C60		CAPACITOR: same as C59.	Screen r-f bypass.
C61		CAPACITOR: same as C59.	B+ supply r-f bypass; combines with R22 forming filter to prevent interstage coupling.
L29	2Z9883	FIRST I-F TRANSFORMER ASSEMBLY; permeability-tuned; 470-kc coils, capacitors, and resistor mounted in aluminum shield.	Couples first i-f amplifier output to input of second i-f amplifier.
R19	3Z4564	RESISTOR, fixed: wire-wound; 500 ohms $\pm 10\%$; 1-w.	Cathode bias.
R20	3Z4563	RESISTOR, fixed: composition; 60,000 ohms $\pm 10\%$; 1-w.	Screen bleeder.
R21	3Z4549	RESISTOR, fixed: composition; 40,000 ohms $\pm 10\%$; 1/2-w.	Screen voltage divider.
R22	3Z4525	RESISTOR, fixed: composition; 1,000 ohms $\pm 10\%$; 1/2-w.	Part of B+ supply filter (see C61).
R23	3Z4550	RESISTOR, fixed: composition; 100,000 ohms $\pm 10\%$; 1/2-w.	Part of a-v-c r-f filter (see C56).
R38	3Z4569	RESISTOR, fixed: composition; 60,000 ohms $\pm 10\%$; 1/2-w; (part of first i-f transformer assembly); (used in all except Radio Receivers BC-312 and BC-312-A).	First i-f transformer primary shunt; broadens band width.

d. REMOVAL OF FIRST I-F TRANSFORMER. Follow the procedure outlined in paragraph 45d.

47. Second I-F Amplifier

a. SPECIAL CIRCUIT FEATURES. The second i-f amplifier circuit is conventional. Signal voltage is taken from the primary of the second i-f transformer and rectified by the second detector for a-v-c voltage. The signal voltage which appears across the secondary of the transformer is coupled to the detector plate of

the second detector. Data on the a-v-c circuit are given in paragraph 53. Refer to the receiver schematic diagram (fig. 54) to check the B+ bus.

b. VOLTAGE AND RESISTANCE MEASUREMENTS. The voltage and resistance measurements shown in figure 27 are made in the manner and under the conditions listed in paragraph 42b.

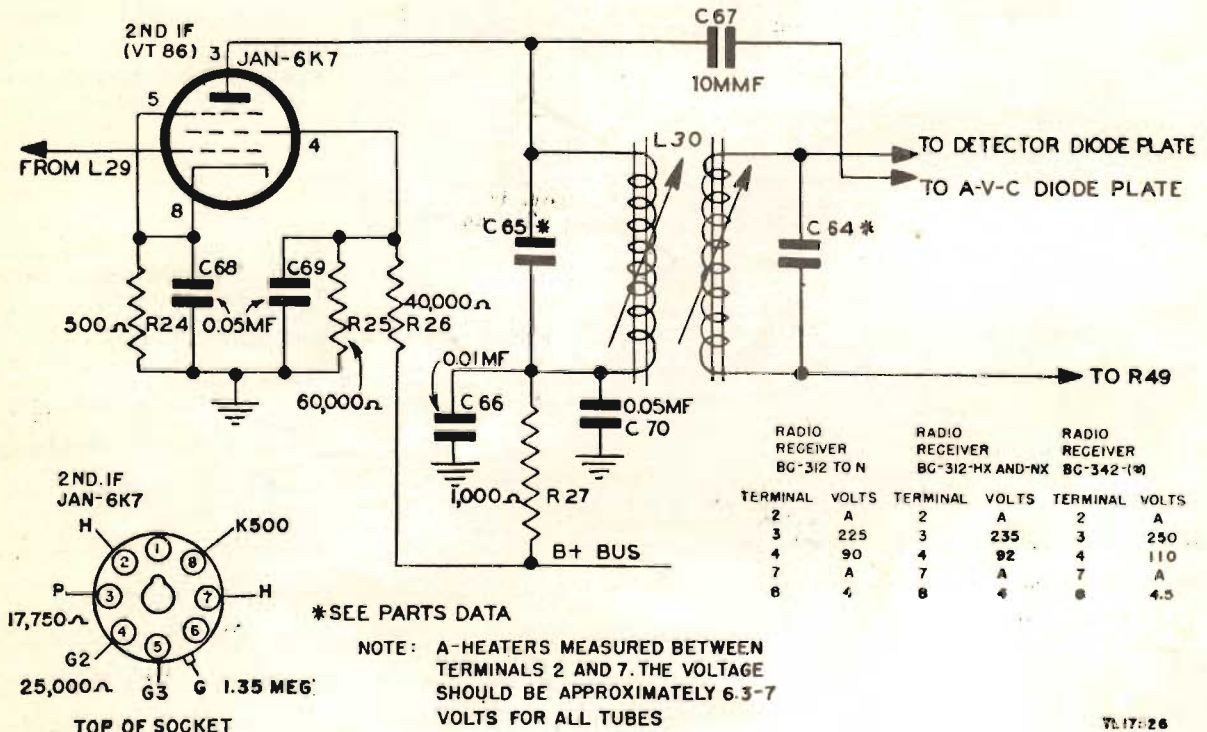

Figure 27. Second i-f amplifier, schematic diagram.

c. PARTS DATA.

Reference symbol	Signal Corps stock No.	Name of part and description	Function
C64	3D295 3D342	CAPACITOR (part of second i-f transformer assembly). Fixed: mica; 50 mmf $\pm 2\%$; 300 vdcw (used in Radio Receivers BC-312 and BC-342). Fixed: silver mica; 100 mmf $\pm 2\%$; 400 vdcw (used in all except Radio Receivers BC-312 and BC-342).	Second i-f transformer secondary tuning.
C65		CAPACITOR: same as C64	Second i-f transformer primary tuning.
C66	3D281 3D371 3D296	CAPACITOR (part of second i-f transformer assembly). Fixed: paper; 0.01 mf $\pm 10\%$; 400 vdcw (used in Radio Receivers BC-312, BC-312-A, -N, -NX, and BC-342-N). Fixed: mica; 0.01 mf $\pm 10\%$; 450 vdcw (used in all except Radio Receivers BC-312, BC-312-A, -N, -NX; BC-342, and BC-342-N). Fixed: mica; 400 mmf $\pm 2\%$; 250 vdcw (used only in Radio Receiver BC-342).	Plate r-f bypass.
C67	3D279	CAPACITOR, fixed: mica; 10 mmf $+14\%$, -6% ; 400 vdcw.	Couples second i-f transformer primary to a-v-c diode plate.
C68	3D301	CAPACITOR, fixed: paper; 3-section, each 0.05 mf $+14\%$, -6% ; 300 vdcw.	Cathode r-f bypass.
C69		CAPACITOR: same as C68	Screen r-f bypass.
C70		CAPACITOR: same as C68	B+ supply r-f bypass; combines with R27 forming filter to prevent interstage coupling.
L30	2Z9884	SECOND I-F TRANSFORMER ASSEMBLY: permeability-tuned; 470-ke coils and capacitors assembled in aluminum shield.	Couples second i-f amplifier to second detector.
R24	3Z4564	RESISTOR, fixed: wire-wound; 500 ohms $\pm 10\%$; 1-w.	Cathode bias.
R25	3Z4563	RESISTOR, fixed: composition; 60,000 ohms $\pm 10\%$; 1-w.	Screen voltage bleeder.
R26	3Z4549	RESISTOR, fixed: composition; 40,000 ohms $\pm 10\%$; 1/2-w.	Screen voltage divider.
R27	3Z4525	RESISTOR, fixed: composition; 1,000 ohms $\pm 10\%$; 1/2-w.	Part of B+ supply filter (see C70).

d. REMOVAL OF SECOND I-F TRANSFORMER. Follow the procedure outlined in paragraph 45d.

48. Second Detector and First Audio Amplifier

a. SPECIAL CIRCUIT FEATURES. The receiver second detector and first audio circuit is conventional. Refer to the receiver schematic diagram (fig. 54) to check the B+ bus.

b. VOLTAGE AND RESISTANCE MEASUREMENTS. The voltage and resistance measurements shown in figure 28 are made in the manner and under the conditions listed in paragraph 42b.

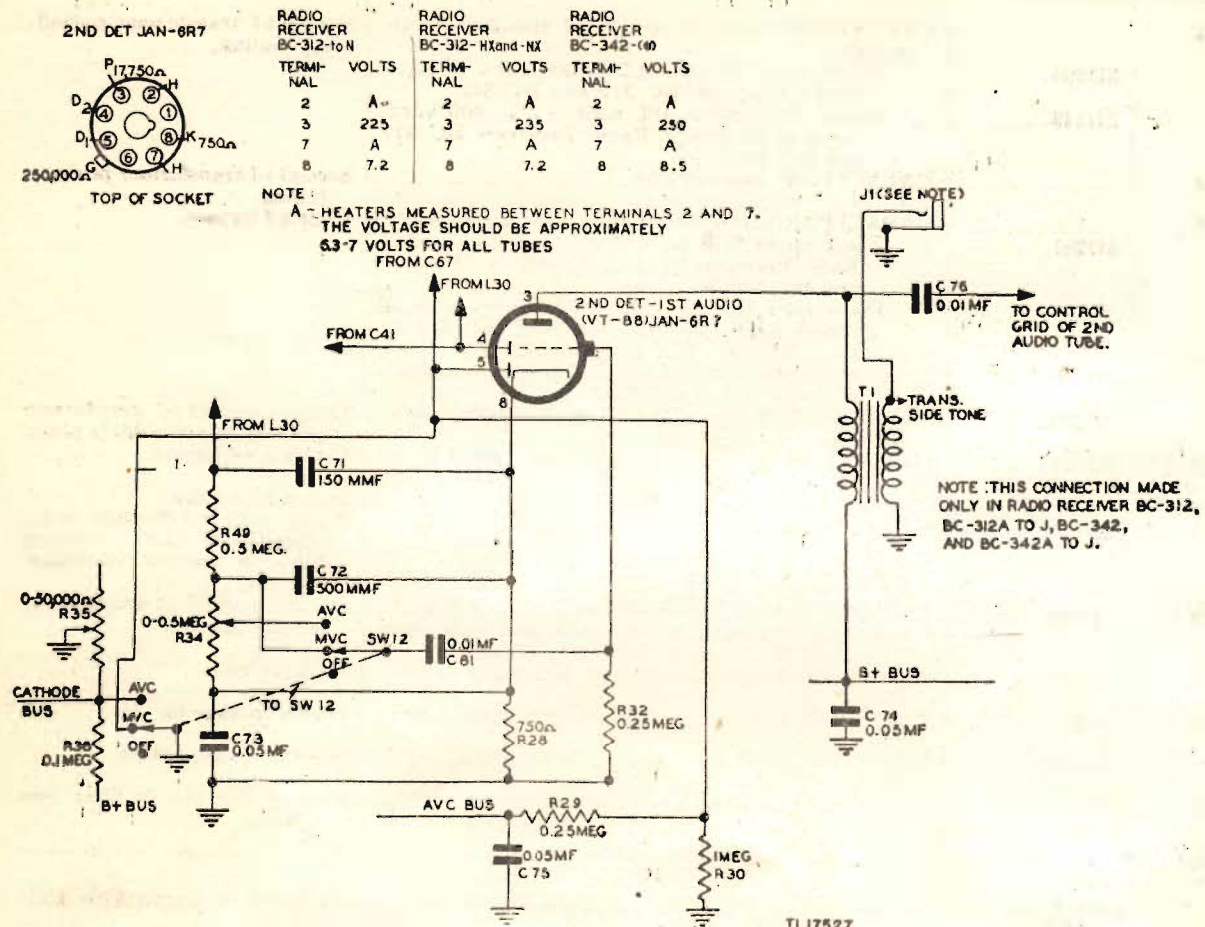

c. PARTS DATA.

Reference symbol	Signal Corps stock No.	Name of part and description	Function
C71	3D218	CAPACITOR, fixed: mica; 150-mmf +14%, -6%; 250 vdew.	Combines with C72 and R49 forming an r-f filter for a-v-c output of second detector.
C72	3D193	CAPACITOR, fixed: mica; 500 mmf +14%, -6%; 250 vdew.	Part of a-v-c r-f filter (see C71).
C73	3D301	CAPACITOR, fixed: paper; 3-section, each 0.05 mf +14%, -6%; 300 vdew.	Cathode r-f bypass.
C74		CAPACITOR: same as C73	B+ supply r-f bypass.
C75		CAPACITOR: same as C73	Combines with R29 forming an r-f filter for a-v-c bus.
C76	3D281	CAPACITOR, fixed: paper; 0.01 mf $\pm 10\%$; 400 vdew; (used only in Radio Receivers BC-312 and BC-312-A).	Couples output of first audio amplifier to input of audio output tube.
C76	3D371	CAPACITOR, fixed: mica; 0.01 mf $\pm 10\%$; 450 vdew; (used in all except Radio Receivers BC-312, BC-312-A, and BC-342).	
C76	3D296	CAPACITOR, fixed: mica; 400 mmf $\pm 2\%$; 250 vdew; (used only in Radio Receiver BC-342).	
C81	3D281	CAPACITOR, fixed: paper; 0.01 mf $\pm 10\%$; 400 vdew.	Couples audio signal to grid of first audio amplifier.
R28	3Z4571	RESISTOR, fixed: wire-wound; 750 ohms $\pm 10\%$; 1-w.	Cathode bias.
R29	3Z4562	RESISTOR, fixed: composition; 250,000 ohms $\pm 10\%$; 1/2-w.	Part of a-v-c r-f filter (see C71).
R30	3Z4561	RESISTOR, fixed: composition; 1 meg. $\pm 10\%$; 1/3-w.	A-v-c diode plate load.
R32		RESISTOR: same as R29	First audio grid load.
R34	2Z7289	POTENTIOMETER: dual-section 1-w Section D: 0-500,000 ohms $\pm 10\%$; right-hand taper L.	Volume control.
R35		Section E: 0-50,000 ohms $\pm 10\%$; left-hand taper L.	
R36	3Z4550	RESISTOR, fixed: composition; 100,000 ohms $\pm 10\%$; 1/2-w; (used in Radio Receivers BC-312, BC-312-A, -C, BC-342, and BC-342-C).	Cathode bias voltage divider.
R36	3Z4511	RESISTOR, fixed: composition; 100,000 ohms $\pm 10\%$; 1-w; (used in all except Radio Receivers BC-312, BC-312-A, -C, BC-342, and BC-342-C).	
SW12	3Z8119	SWITCH, rotary: three-position; (off position extreme counterclockwise).	OFF—M. V. C.—A. V. C. switch.
T1	2Z9805	TRANSFORMER	Side tone transmitter monitoring; output for PHONES 1ST AUDIO in some models.

49. C-W Oscillator

a. SPECIAL CIRCUIT FEATURES. The receiver c-w oscillator uses a modified Hartley circuit. A portion of the r-f voltage developed in the tank circuit is fed through a low-pass filter and a coupling capacitor to the diode

detector plate. Refer to the schematic diagram (fig. 54) to check the B+ bus.

b. VOLTAGE AND RESISTANCE MEASUREMENTS. The voltage and resistance measurements shown in figure 29 are made in the manner and under the conditions listed in paragraph 42b.

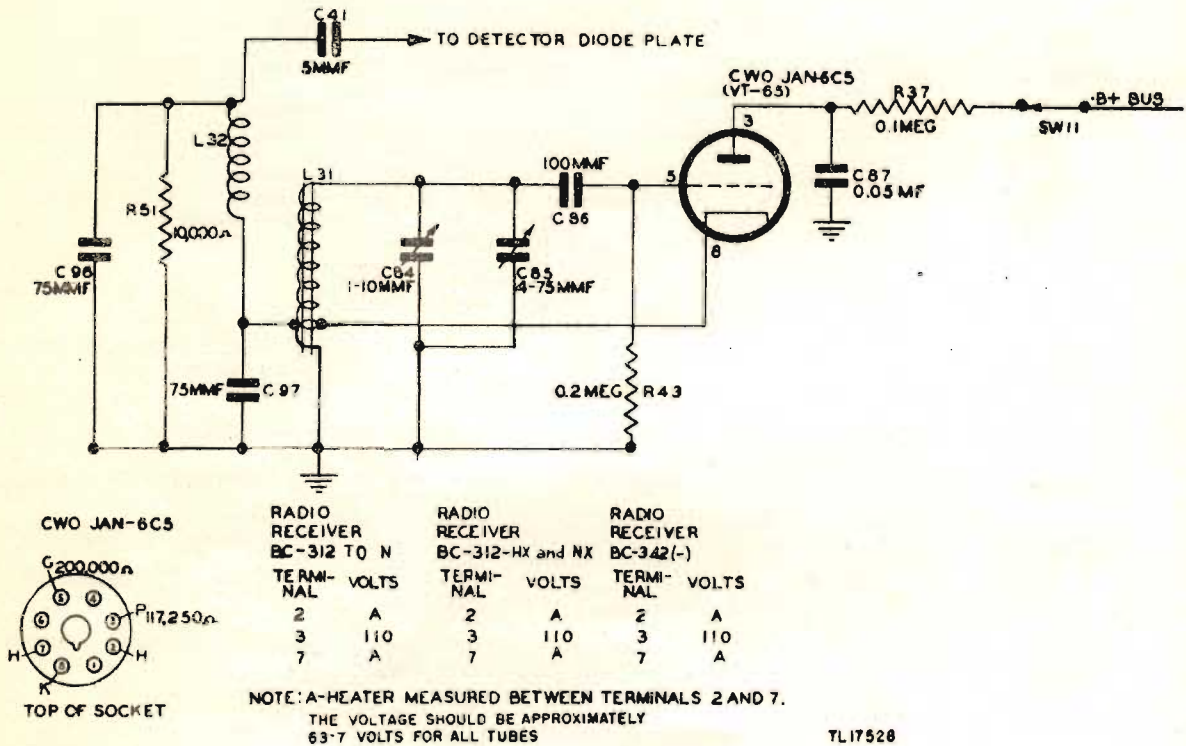

Figure 29. C-w oscillator, schematic diagram.

c. PARTS DATA.

Reference symbol	Signal Corps stock No.	Name of part and description	Function
C41	3D278	CAPACITOR, fixed: mica; 5-mm ² + 14%, -6%; 300 v _{dew} .	Couples c-w oscillator output to detector diode plate.
C84	3D280	CAPACITOR, variable: air; 10-mm ² ; (used only in Radio Receivers BC-312, BC-312-A, -C, and BC-342-C).	
C84	3D383	CAPACITOR, variable: air; 1- to 10-mm ² ; (used in all except Radio Receivers BC-312, BC-312-A, -C, and BC-342-C).	
C85	3D253	CAPACITOR, variable: air; 20-plate, 4 to 75-mm ² .	C-w oscillator trimmer.
C86	3D266	CAPACITOR, fixed: mica; 100 mm ² + 14%, -6%; 250 v _{dew} .	Couples c-w oscillator grid to tank circuit.
C87	3D284	CAPACITOR, fixed: paper; 0.05 mf ± 10%; 400 v _{dew}	Plate r-f bypass; completes plate r-f circuit; combines with R37 forming B+ supply r-f filter.
C96, C97	3D286	CAPACITOR, fixed: mica; 75 mm ² + 14%, -6%; 250 v _{dew} .	Combines with C97, L32, and R51 forming low-pass r-f filter.
L31	2C2775/2	COIL, iron-core; 1.08 mh ± 2%, at 1,000 cycles.	Tank inductance.
L32	2C2775/3	COIL, choke: 6.7 mh ± 2%, at 1,000 cycles.	Part of low-pass r-f filter (see C96).
R37	3Z4550	RESISTOR, fixed: composition; 100,000 ohms ± 10%; 1/2-w.	Part of B+ supply r-f filter interstage decoupling.
R43	3Z4548	RESISTOR, fixed: composition; 200,000 ohms ± 10%; 1/2-w.	Grid load.
R51	3Z4529	RESISTOR, fixed: composition; 10,000 ohms ± 10%; 1/2-w.	Part of low-pass r-f filter (see C96).
SW11	3Z8105	SWITCH, toggle: SPST; 3 amp; 250-v; (used only in Radio Receivers BC-312, BC-312-A, and BC-342).	C-w oscillator on-off switch.
SW11	3Z8139	SWITCH; toggle: SPST; (used in all except Radio Receivers BC-312, BC-312-A, and BC-342).	

d. REMOVAL OF C-W OSCILLATOR UNIT ASSEMBLY.

- (1) Remove the four screws holding the shield in place; remove the shield.
- (2) Remove the two roundhead screws which hold the assembly to the chassis.
- (3) Remove the CW-OSC ADJUST knob,

the C. W.-OSC switch, and the machine screw located below the CW-OSC ADJUST knob.

(4) Unsolder the wires attached to the terminal strip and filter coil; withdraw the unit from the chassis.

(5) Tag each wire before it is detached.

50. Second Audio Amplifier

a. SPECIAL CIRCUIT FEATURES. The receiver second audio circuit is conventional. Output transformer T2 did not use a 250-ohm tap in Radio Receivers BC-312 through -J and BC-342 through -J. In later models, including Radio Receiver BC-312-HX and -NX, maintenance personnel must use the 4,000-ohm tap

when making the tests outlined in sections V, VI, and VII.

b. VOLTAGE AND RESISTANCE MEASUREMENTS. The voltage and resistance measurements shown in figure 30 are made in the manner and under the conditions listed in paragraph 42b.

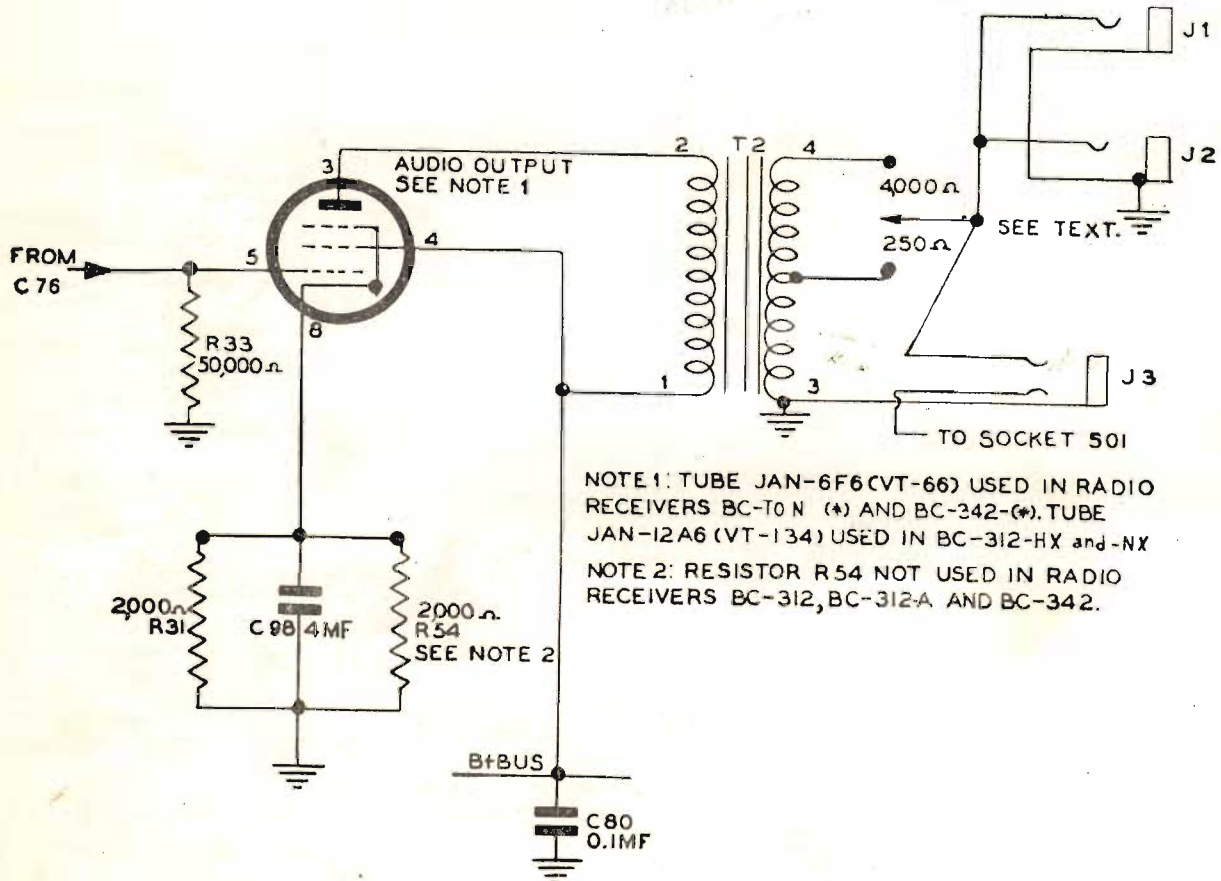

NOTE 1: TUBE JAN-6F6 (VT-66) USED IN RADIO RECEIVERS BC-T0 N (*) AND BC-342-(*). TUBE JAN-12A6 (VT-134) USED IN BC-312-HX and -NX
 NOTE 2: RESISTOR R54 NOT USED IN RADIO RECEIVERS BC-312, BC-312-A, AND BC-342.

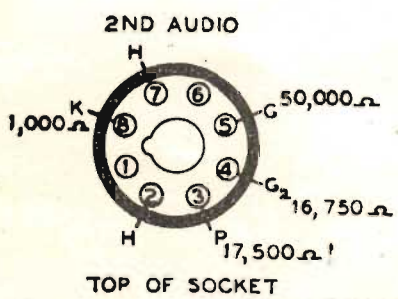

RADIO RECEIVER BC-312-T0 N		RADIO RECEIVER BC-312-HX and NX		RADIO RECEIVER BC-342-(*)	
TERMI-NAL	VOLTS	TERMI-NAL	VOLTS	TERMI-NAL	VOLTS
2	A	2	A	2	A
3	225	3	232	3	240
4	235	4	245	4	260
7	A	7	A	7	A
8	22	8	16.4	8	25

NOTE: A - HEATERS MEASURED BETWEEN TERMINALS 2 AND 7. THE VOLTAGE SHOULD BE APPROXIMATELY 68-7 VOLTS FOR ALL TUBES

TL17529

Figure 30. Second audio amplifier, schematic diagram.

c. PARTS DATA.

Reference symbol	Signal Corps stock No.	Name of part and description	Function
C80	3D276	CAPACITOR, fixed: paper, 3-section; each 0.01 mf +14%, -6%; 400 vdcw.	B + supply a-f bypass.
C98	3D275	CAPACITOR, fixed: paper; 4 mf +14%, -6%; 50 vdcw.	Cathode a-f bypass.
J1, J2	2Z5534A	JACK, phone	Output for phones.
J3	2Z5533A	JACK, 3-circuit speaker	Output for speaker.
R31	3Z4565	RESISTOR, fixed: wire-wound; 1,000 ohms $\pm 10\%$; 1-w; (used in Radio Receivers BC-312-A, and BC-342).	Cathode bias.
R31	3Z4623	RESISTOR, fixed: wire-wound; 2,000 ohms $\pm 10\%$; 1-w; (used in all except Radio Receivers BC-312, BC-312-A, and BC-342).	
R33	3Z4531	RESISTOR, fixed: composition; 50,000 ohms $\pm 10\%$; 1/2-w.	Grid load.
R54		RESISTOR: same as R31; (used in all except Radio Receivers BC-312, BC-312-A, and BC-342).	Cathode bias.
T2	2Z9760	TRANSFORMER, audio-output: 4,000-ohm impedance secondary; (used in Radio Receivers BC-312 through -J and BC-342 through -J).	Couples output of second audio tube to phone and speaker jacks.
	2Z9760A	TRANSFORMER, audio-output: 250-ohm secondary tap; (used in Radio Receivers BC-312-L through -N, -HX, and -NX and BC-342-L through -N).	

b. PARTS DATA.

Reference symbol	Signal Corps stock No.	Name of part and description	Function
C78, C79	3D276	CAPACITOR, fixed: paper; 3-section, each 0.01 mf +14%-6%; 400 vdw.	Tube heater r-f bypass.
C89	3D211	CAPACITOR, fixed: paper, 0.002-mf; 250 vdw.	Tube heater r-f bypass.
C90		CAPACITOR: same as C89	Oscillator compartment heater
C89, C90	3D329	CAPACITOR, electrolytic: 2-section, each 8 mf; 450 vdw; (part of Rectifier RA-20).	r-f bypass. B supply filter.
DM	3H1621()	DYNAMOTOR: 235-vdw output at 90 ma, 12- to 14-v input; (includes Filter FL-6-6(*); (used only for 12-v models).	Plate power supply..
	3H1621()X	DYNAMOTOR: same as above with 24- to 28-v input; (used only for Radio Receivers BC-312-HX and -NX).	
F1	3Z1921A	FUSE, cartridge-type: 10-amp, 25-v; (used only in 12-v models).	Dynamotor and filament circuit overload protection.
F2		FUSE: same as F1	Dial lamp circuit overload protection.
F3	3Z1927	FUSE, cartridge-type: 2-amp; 250-v; (part of Rectifier RA-20).	A-c line overload protection.
F4	3Z1925A	FUSE, cartridge-type: 5-amp, 25-v; (used only in 24-v models).	Dynamotor and filament circuit overload protection.
F5		FUSE: same as F4	Dial lamp circuit overload protection.
J4	2Z5533A	JACK, microphone: 3-circuit	Remote operation of transmitter.
J5	2Z5534A	JACK, key	Remote operation of transmitter.
L35	3C227	COIL, choke: 14.5 henry; (part of Rectifier RA-20).	B supply filter.
LM2, LM3	2Z5927	LAMP: 0.25-amp; 6.3-v; miniature bayonet base; (used in Radio Receivers BC-312-(*)) and BC-342-(*)).	Dial illumination.
LM4, LM5	2Z5942	LAMP: 0.15-amp; 18-v; miniature bayonet base; (used only in Radio Receiver BC-312-(*))X).	Dial illumination.
R38, R39, R40	3Z4578	RESISTOR, metal-enclosed: 12-ohm; 15-w, 14-v; (used only in Radio Receivers BC-312 and BC-342).	Oscillator compartment heater.
R40	3Z4620	RESISTOR, fixed: composition; 65,000 ohms; 2-w; (part of Rectifier RA-20).	B supply bleeder.
R47	3Z4576	RESISTOR, fixed: composition; 60 ohms $\pm 10\%$; $\frac{1}{2}$ -w; (used only in Radio Receiver BC-312 to -N).	Filament voltage equalizer.
R55	3Z4667	RESISTOR, fixed: molded; 75-ohm; 15-w; (used only in Radio Receiver BC-312-HX and -NX).	Filament voltage dropping.
R55	3Z7256	RHEOSTAT, wire-wound: 75 ohm; 2-w; (used in Radio Receivers BC-312-L and -M).	Dial lamp control.
R56		RHEOSTAT: same as R55 (used only in Radio Receivers BC-312-N and -NX).	
	2Z7512	RECTIFIER RA-20: (complete a-c power supply consisting of rectifier tube, PI-type filter, and transformer).	Plate power supply.
RL1	2Z7613	RELAY, antenna: (used in Radio Receivers BC-312 to -N; closes at 7-8 v; 60-ohm d-c resistance.	Antenna grounding; audio disabling in late models.
RL2	2Z7641A	RELAY, antenna: (used in Radio Receivers BC-312-HX and -NX); closes at 15- to 18-v 145-ohm d-c resistance.	Antenna grounding; audio disabling.
SO1	2Z8794.1	SOCKET, male: 14-contact	Power supply; controls cable connection.
SO2	2Z7589	CONNECTOR: 2-contact; (part of Rectifier RA-20).	A-c input.
SW1	3Z8131	SWITCH, toggle: SPST; 3-amp; 250-v	Send-receive switch.
SW13		SWITCH: same as SW1	Oscillator heater switch.
SW13	3Z8105	SWITCH, toggle: SPST; 3-amp; 250-v; (part of Rectifier RA-20).	A-c line switch.

b. PARTS DATA.—Continued.

Reference symbol	Signal Corps stock No.	Name of part and description	Function
T3	2Z9828	TRANSFORMER, power: 110- to 120-v, 60-cycle primary; 700-v; center-tapped, 100-ma secondary; 5-v, 3-amp secondary; 12.5-v, 2-amp secondary; and 12.5-v, 3-amp secondary; (part of Rectifier RA-20).	Rectifier power transformer.
THS1	2Z9182	THERMOSTAT: 2.3-amp, 14-v; normally closed; opens at 111° F; (used only in Radio Receivers BC-312 and BC-342.)	Oscillator compartment temperature control.
THS2	2Z9181	THERMOSTAT: 1.15-amp, 14-v; normally closed; opens at 109° F; (used only in Radio Receivers BC-312 and BC-342).	Oscillator compartment temperature control.

Faint, illegible text at the top of the page, possibly a header or introductory paragraph.

A large, faint grid or table structure occupying the middle section of the page. The grid lines are very light, and any text within the cells is illegible.

Faint, illegible text at the bottom of the page, possibly a footer or concluding paragraph.

52. Noise Suppression Circuit

- a. When the noise suppression circuit is defective, remove receiver chassis from its case.
- b. Rotate the FAST TUNING KNOB counterclockwise until tuning gang is at a position of maximum capacitance.
- c. Remove the wire connected between the lug on antenna trimmer C26, and the lug on the insulated mounting on the chassis below. (The lug on the antenna trimmer is further identified as being connected to a neon lamp.)
- d. Disconnect the wire connecting the signal antenna post to the noise suppression circuit at the noise suppression unit housing. This housing is located on the bottom of the chassis near the front panel and between the oscillator and the first r-f coil sections.
- e. Using a piece of stiff wire as a hook, take the lead disconnected in d above across the front of the oscillator section and below antenna trimmer C26 to the lug on the antenna trimmer. (This lug is further identified as being connected to a neon lamp.) Cut off the excess wire and solder lead to lug on antenna trimmer C26.
- f. Check alignment of receiver.
- g. Replace receiver in chassis.
- h. Check performance of receiver.

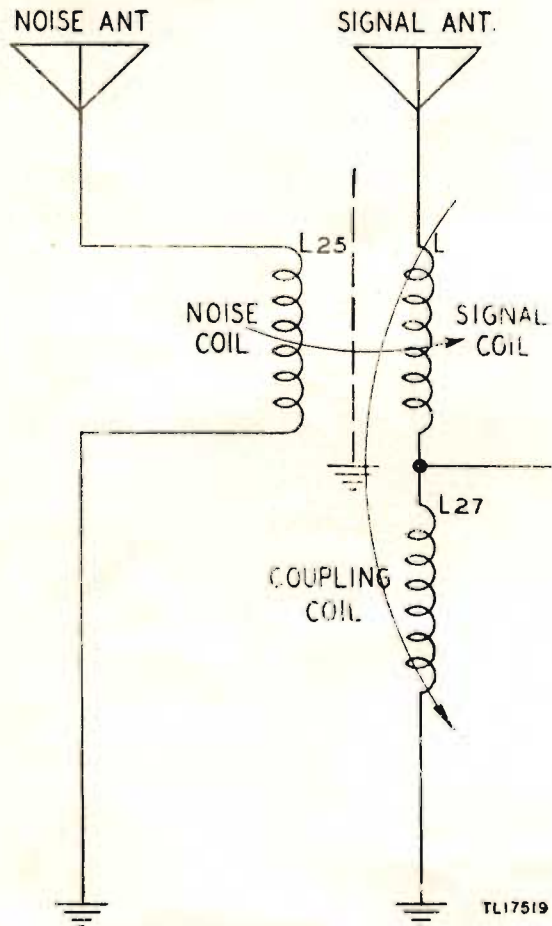

Figure 33. Noise suppression circuit, schematic diagram.

i. PARTS DATA.

Reference symbol	Signal Corps stock No.	Name of part and description	Function
L25, L26, L27	2Z6845	NOISE SUPPRESSOR ASSEMBLY: consists of noise, signal, and coupling coils (used only in Radio Receivers BC-312 and -C).	Reduces motor ignition interference.

53. A-V-C and M-V-C Circuits

The automatic-volume-control and manual-volume-control circuits of the receiver are inter-related. Figure 34 shows each of these circuits in simplified form. The a-v-c filters, resistors, and capacitors, cathode bypasses, and coils, in-

corporated in the receiver stages (figs. 22 through 26) and controlled by the a-v-c and m-v-c action, have been omitted from this simplified diagram; however, they must be considered when making a check of the circuits.

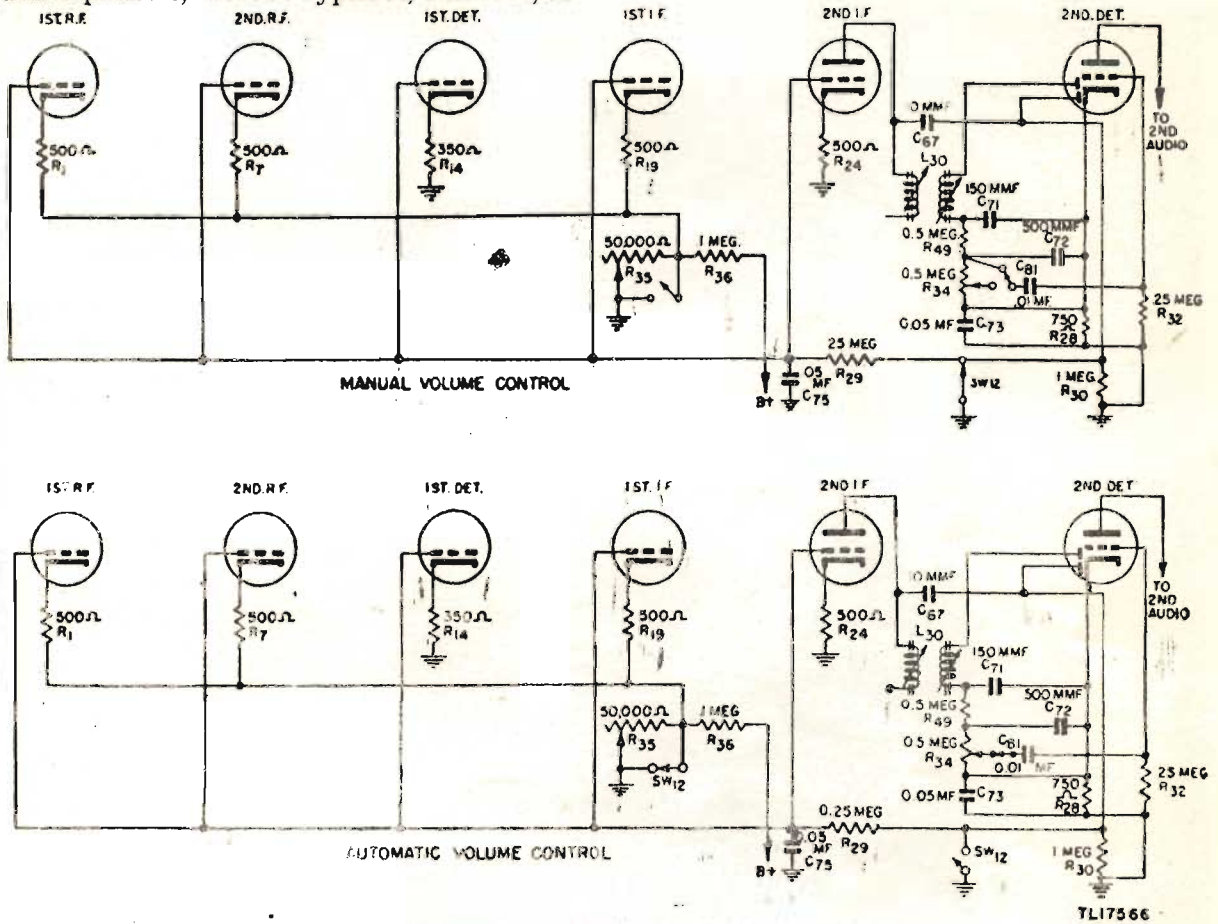

Figure 34. A-v-c and m-v-c circuits, simplified schematic diagram.

SECTION IX SUPPLEMENTARY DATA

54. Parts Identification

The following illustrations are provided to aid in identifying and servicing the various com-

ponent parts of Radio Receivers BC-312-(*) and BC-342-(*)

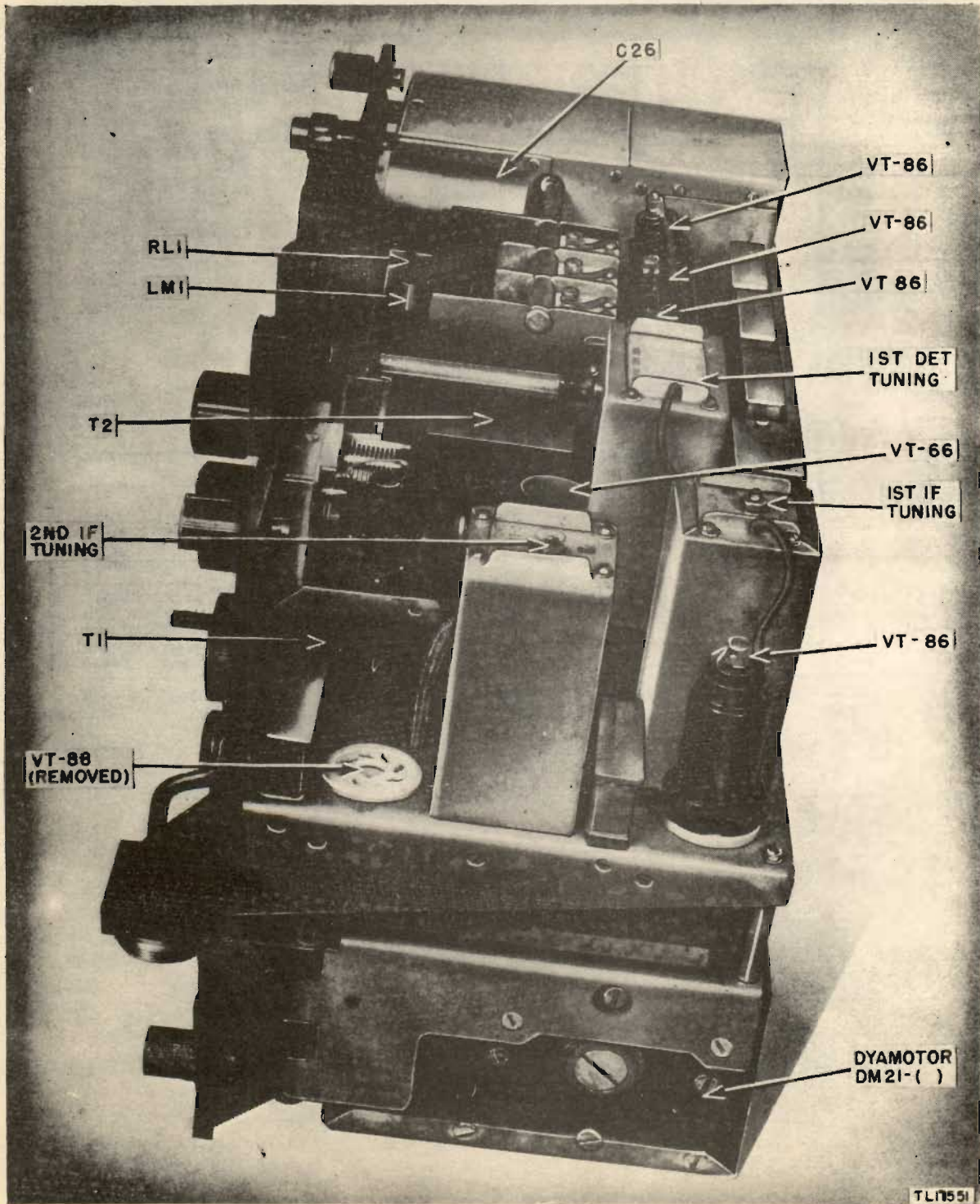

Figure 35. Radio Receiver BC-312-D, chassis top view.

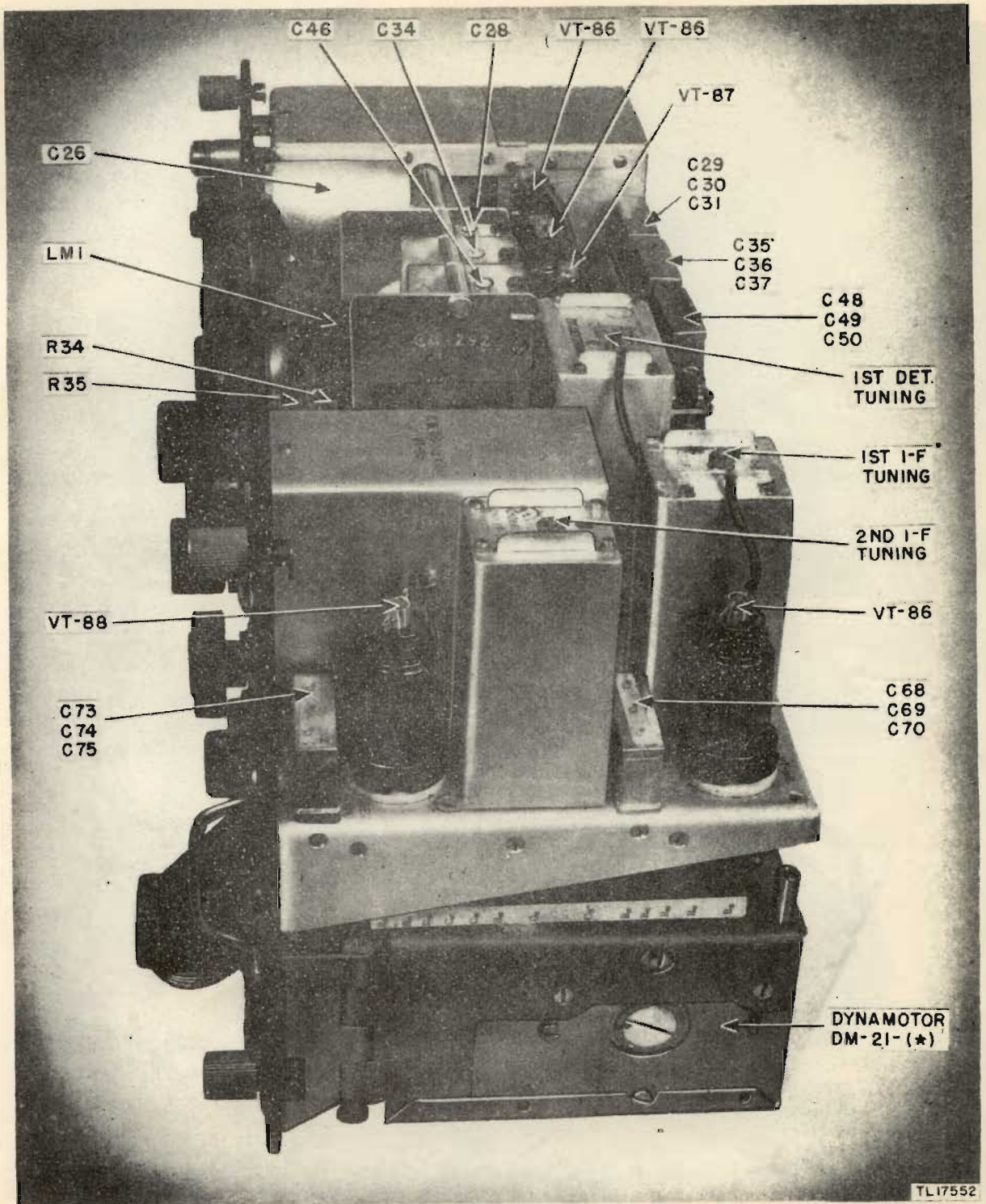

Figure 36. Radio Receiver BC-312-M, chassis top view.

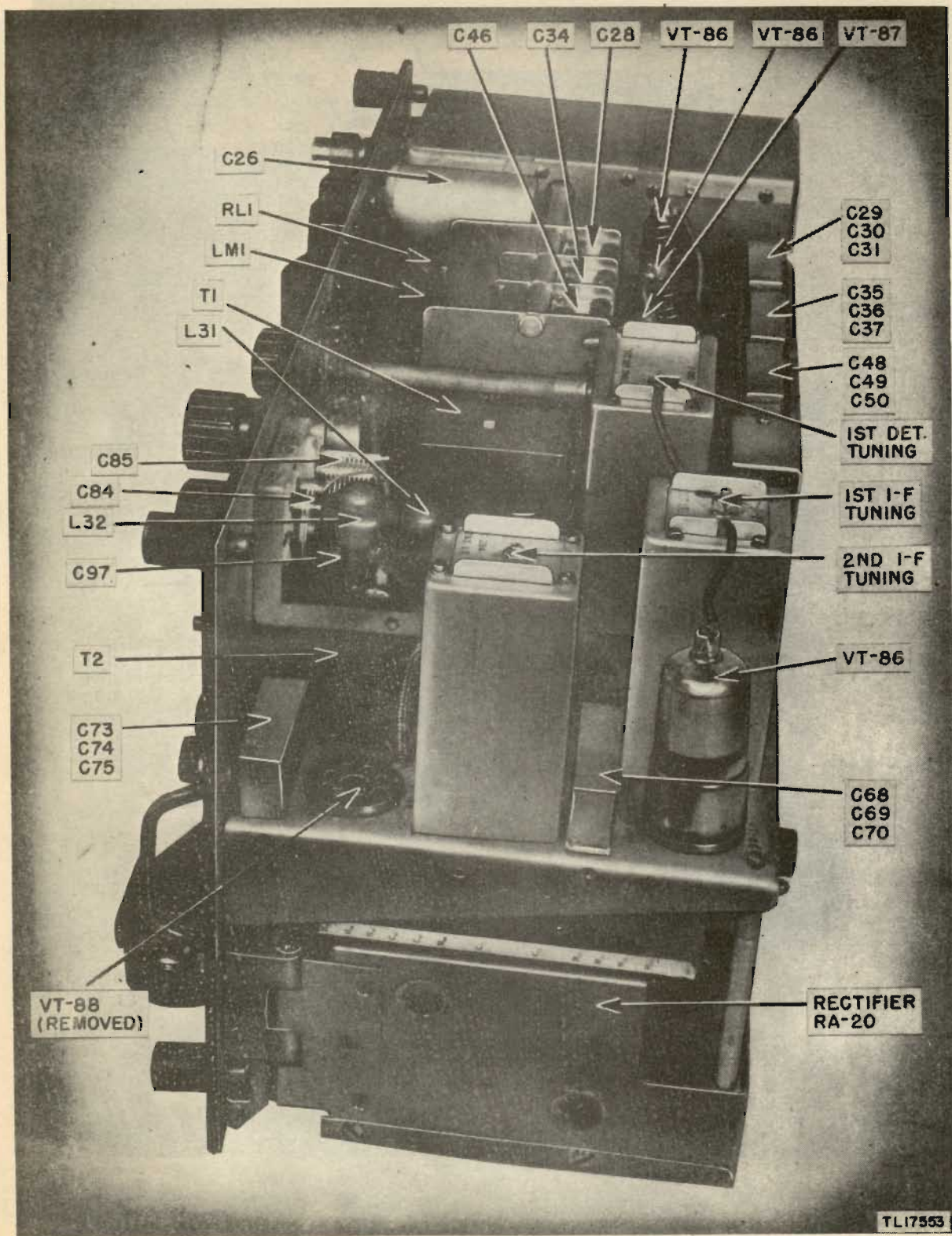

Figure 37. Radio Receiver BC-342-(*), chassis top view.

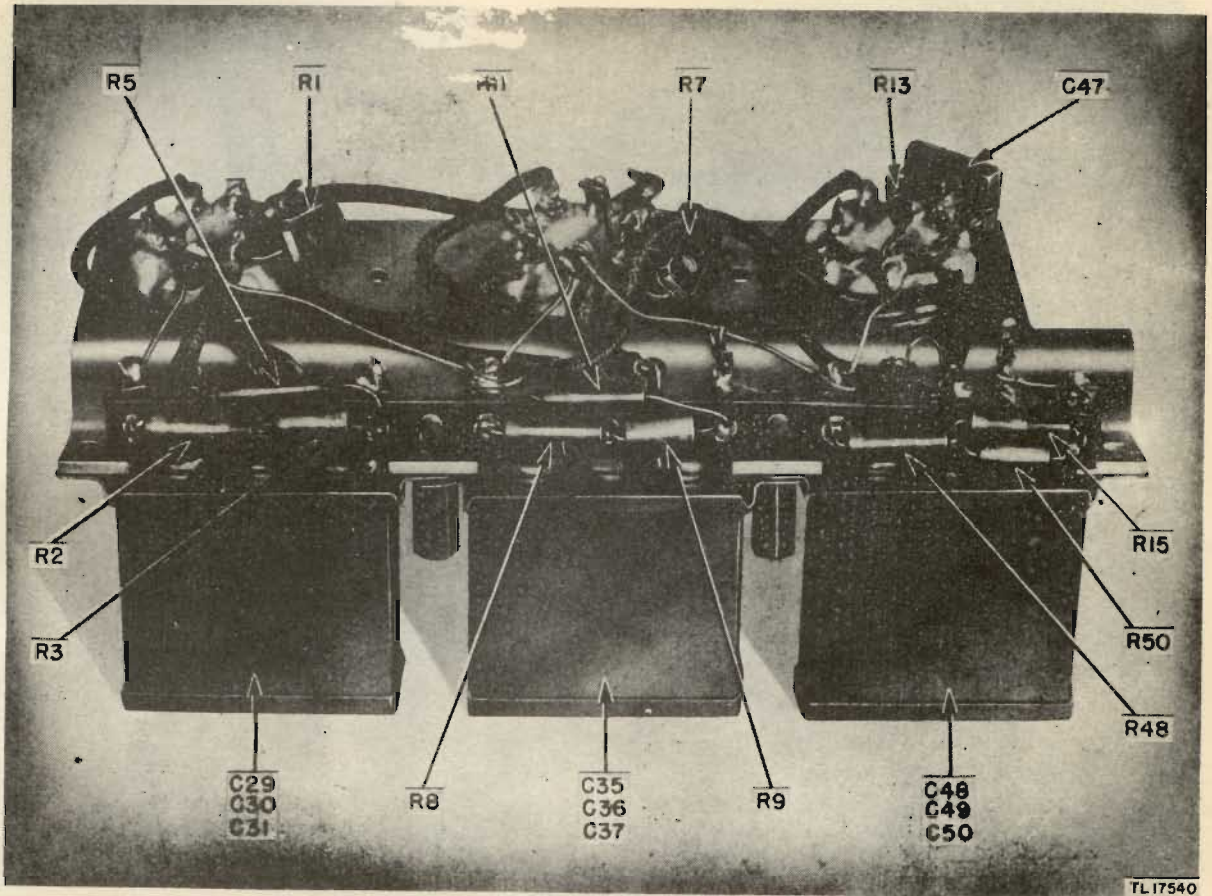

Figure 38. Receiver tube shelf, parts location.

TL17540

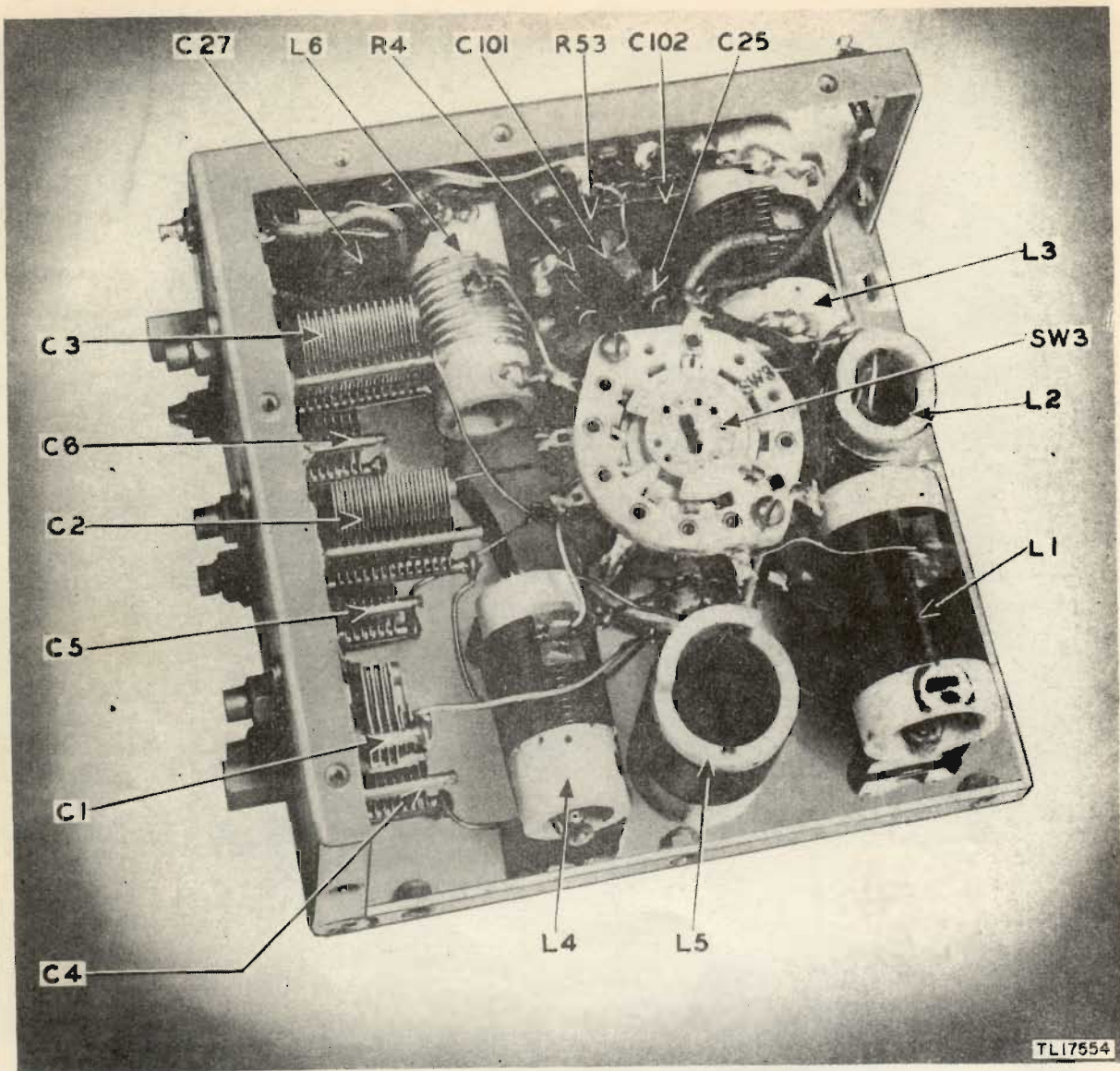

Figure 39. First r-f tuning unit, parts location.

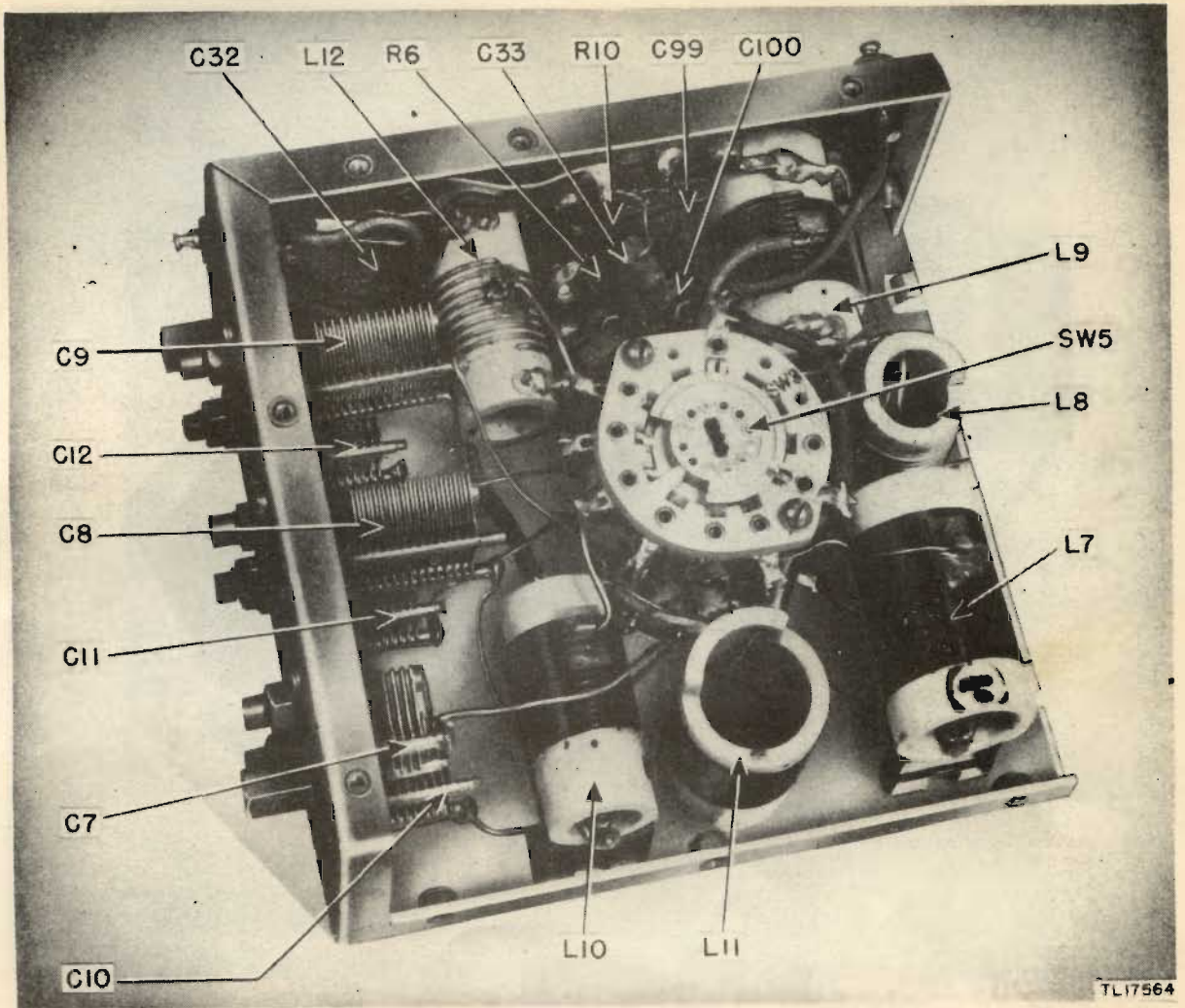
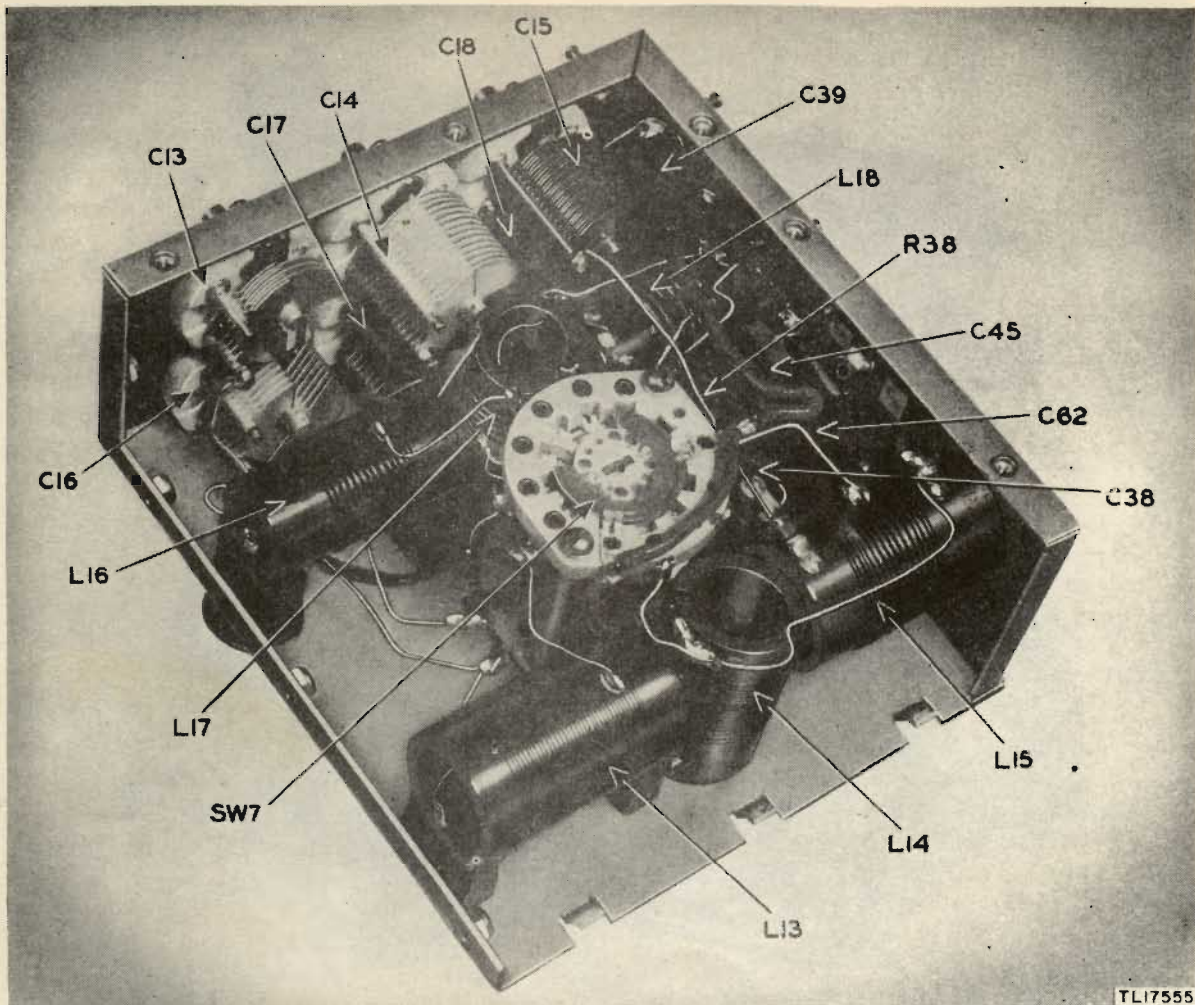

Figure 40. Second r-f tuning unit, parts location.



TL17555

Figure 41. First detector tuning unit, parts location.

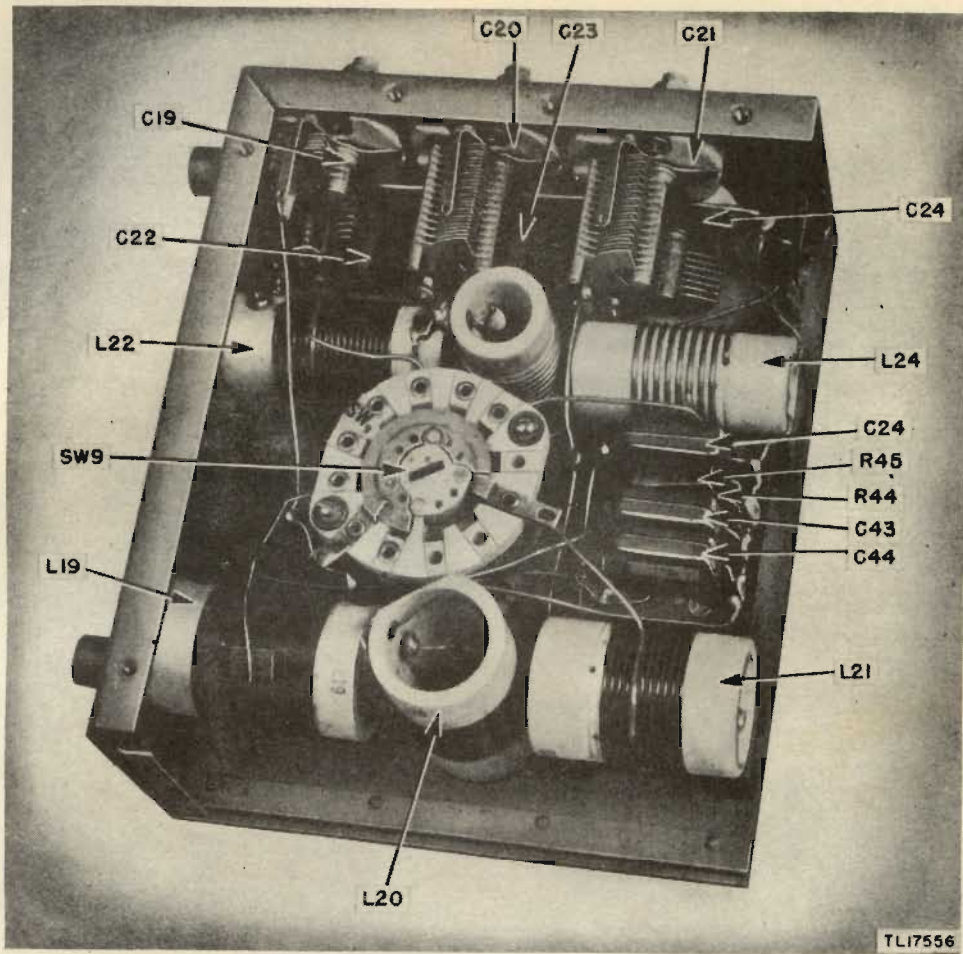
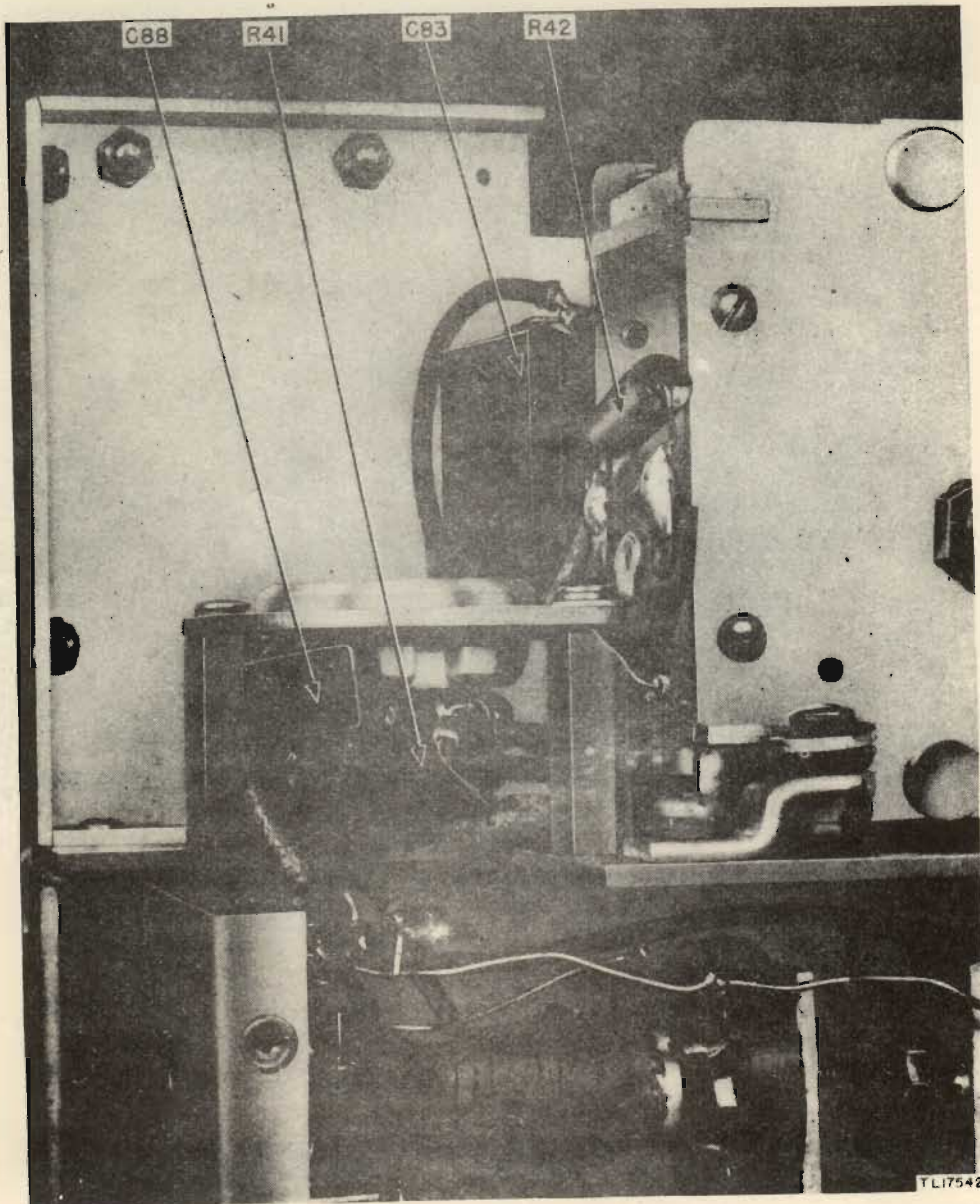

Figure 42. R-f oscillator tuning unit, parts location.



TL17542

Figure 43. R-f oscillator compartment, parts location.

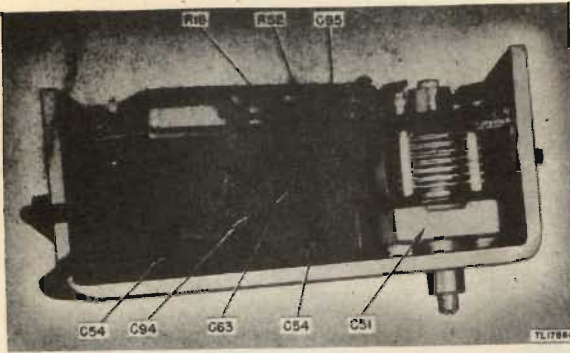

Figure 44. First detector unit assembly containing crystal filter, parts location, side view.

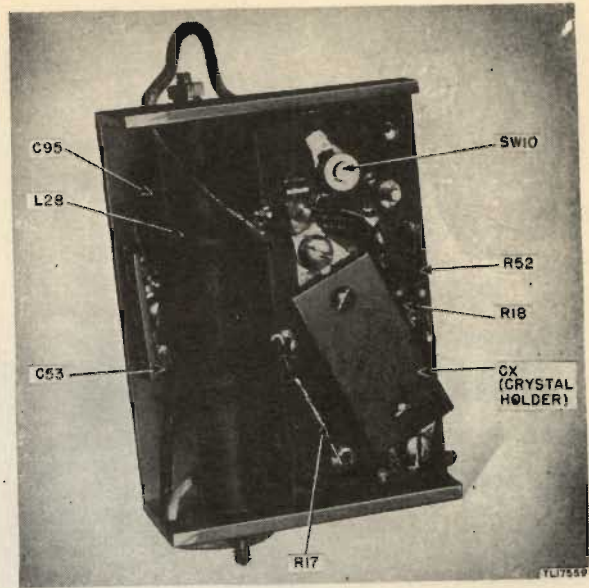

Figure 45. First detector unit assembly containing crystal filter, parts location, front view.

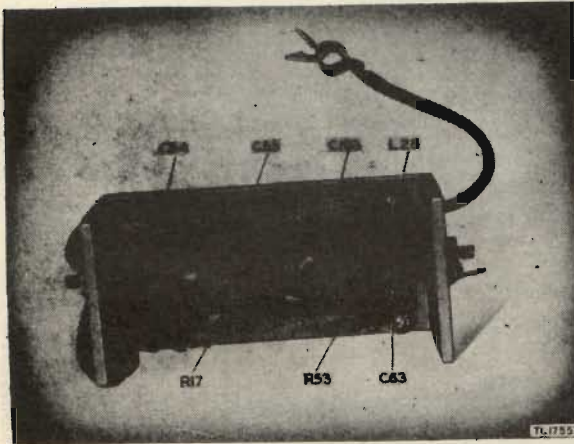

Figure 46. First detector unit assembly without crystal filter, parts location.

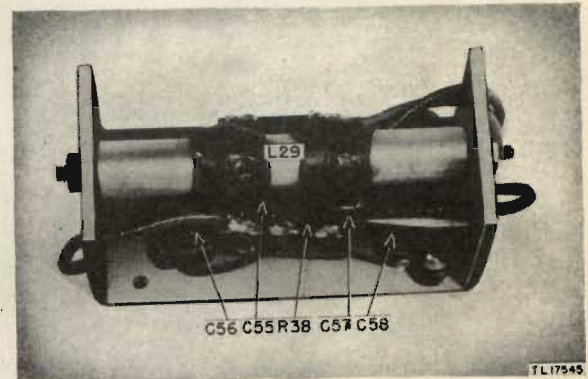

Figure 47. First i-f unit, parts location.

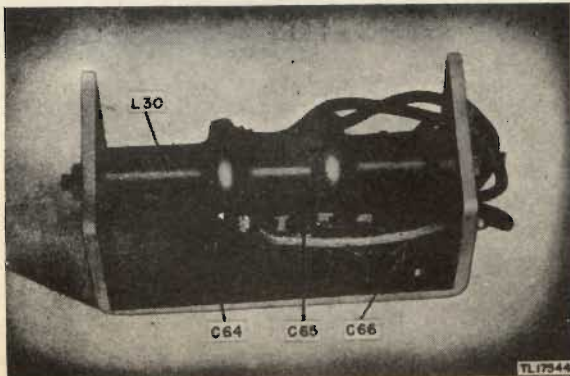

Figure 48. Second i-f unit, parts location.

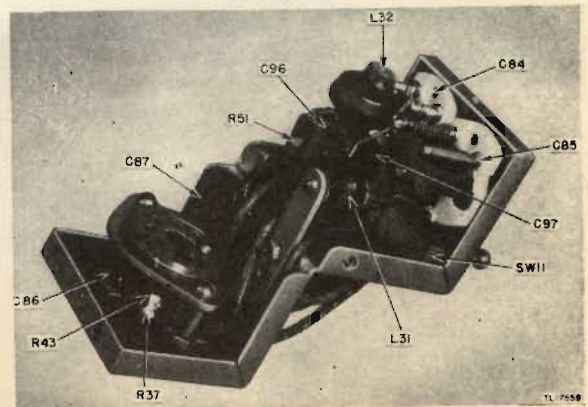

Figure 49. C-w oscillator unit, parts location.

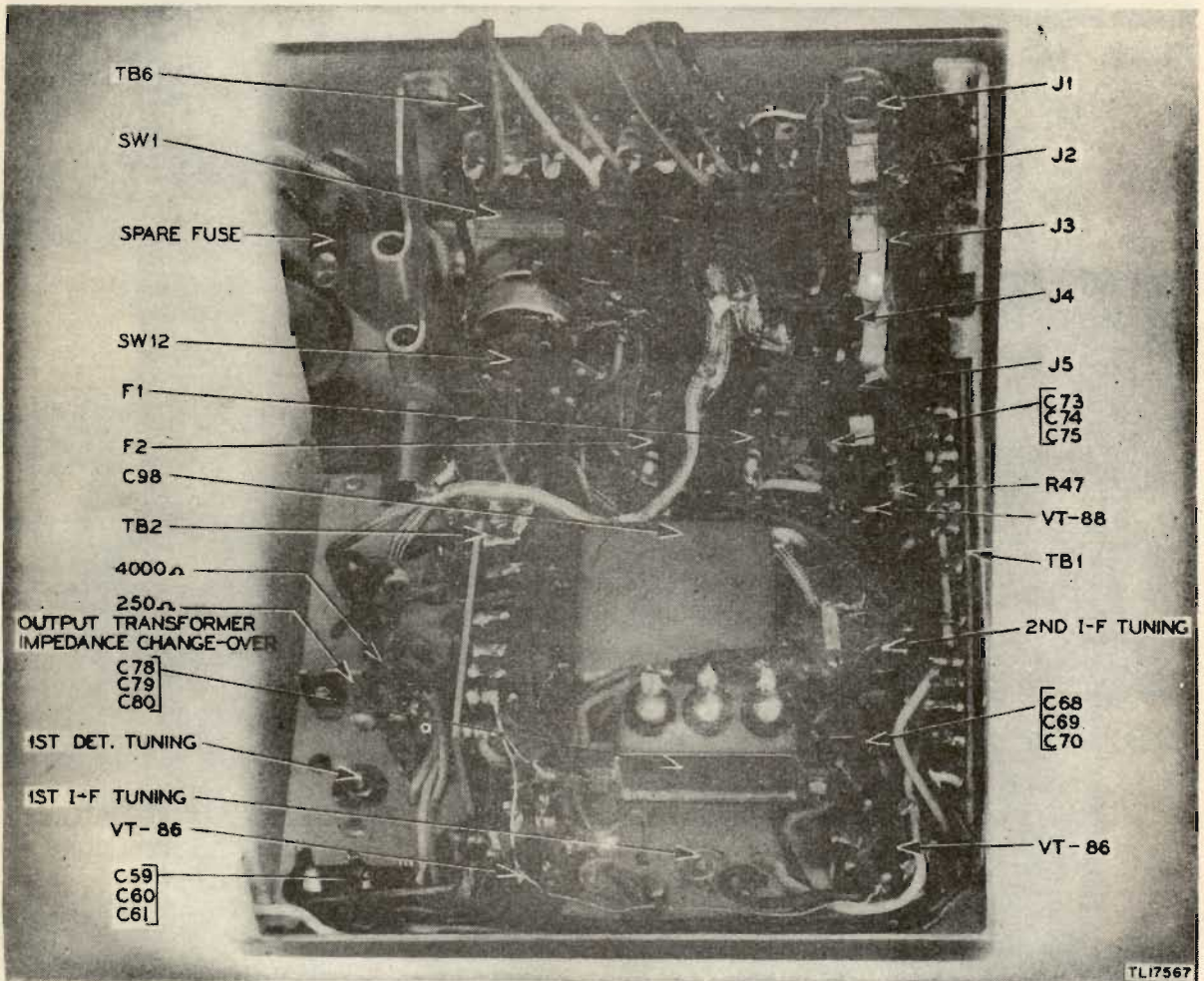

Figure 50. Chassis base, parts location.

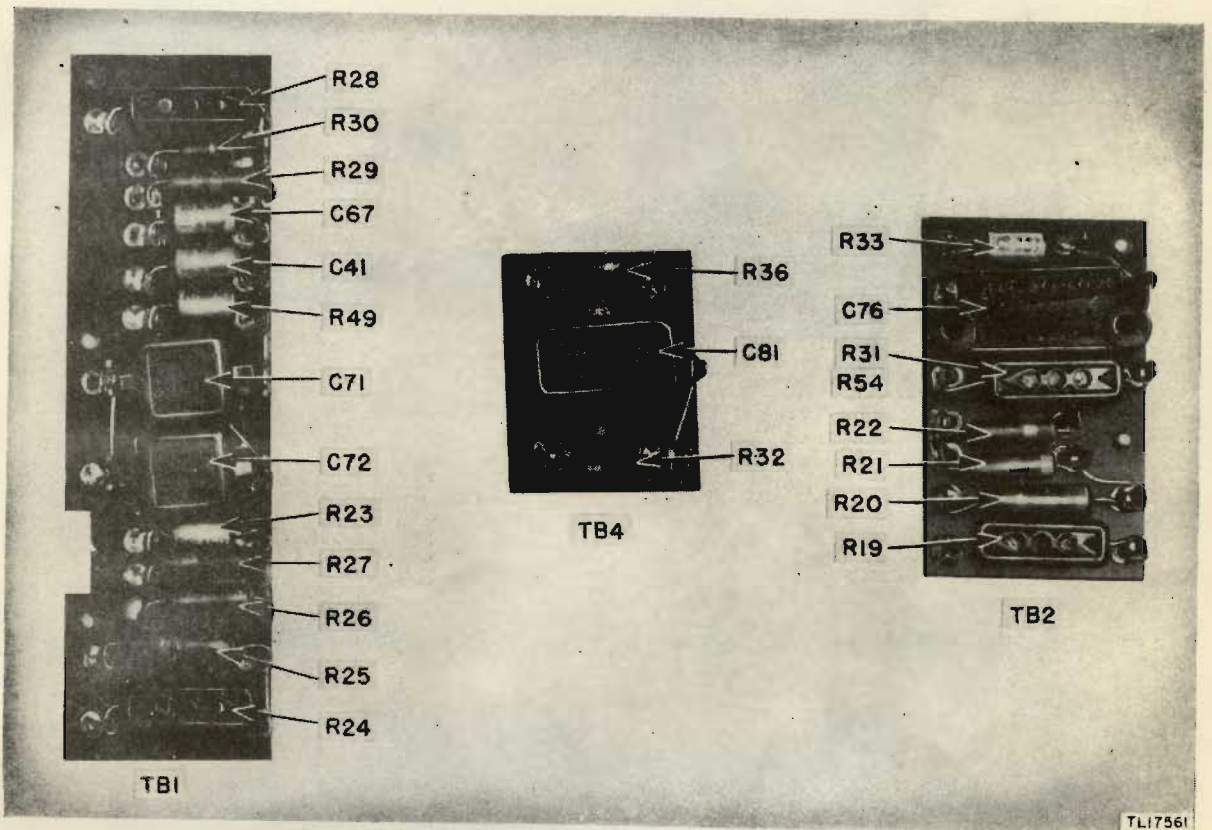

Figure 51. Terminal boards, parts location.

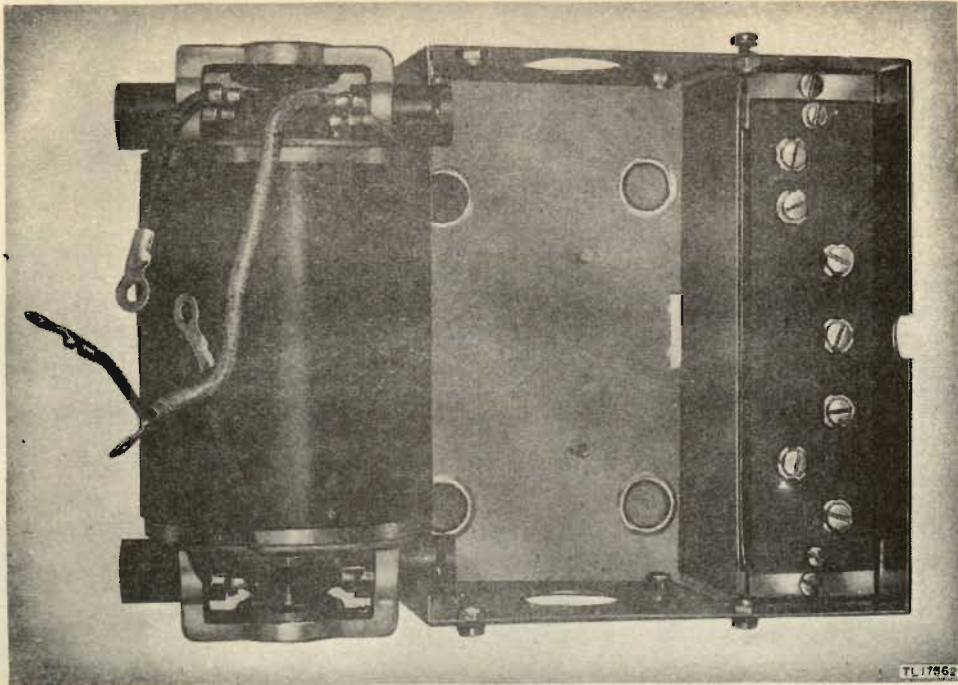

Figure 52. Dynamotor removed from dynamotor unit.

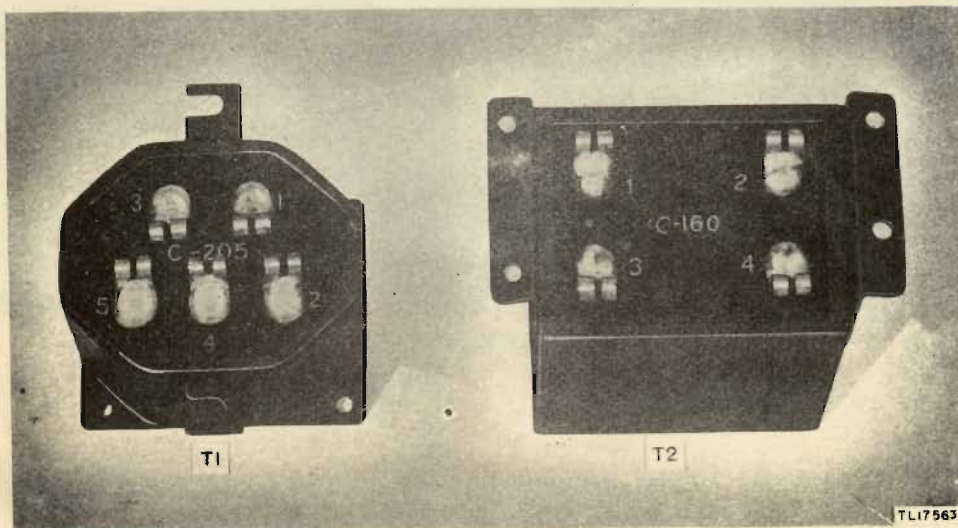
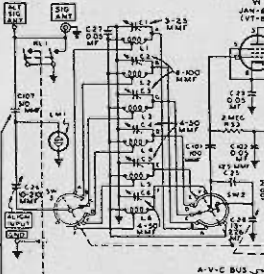
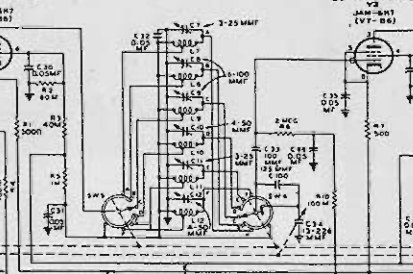

Figure 53. Transformers T1 and T2, terminals.

1ST R-F AMPLR



2D R-F AMPLR



MIXER

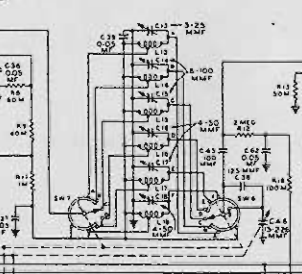

1ST I-F AMPLR

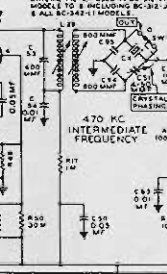

2D I-F AMPLR

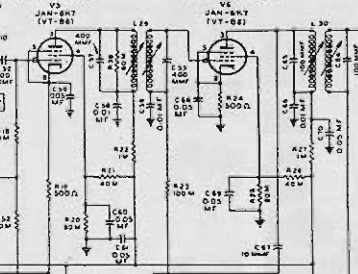

AVOID DISABLING IN BC-312-MX, M, N AND M-L MODELS AND IN BC-342-MX, M, N, AND M-L MODELS ONLY

TYPICAL PLUG SO CONNECTIONS

- D-C OPERATION**
- 1 FILAMENT-12V
 - 2 FILAMENT-12V
 - 3 W. M. RING
 - 4 500 TONE
 - 5 500 TONE
 - 6 500 TONE
 - 7 500 TONE
 - 8 500 TONE
 - 9 500 TONE
 - 10 500 TONE
 - 11 500 TONE
 - 12 500 TONE
 - 13 500 TONE
 - 14 500 TONE
 - 15 500 TONE
 - 16 500 TONE
 - 17 500 TONE
 - 18 500 TONE
 - 19 500 TONE
 - 20 500 TONE
 - 21 500 TONE
 - 22 500 TONE
 - 23 500 TONE
 - 24 500 TONE
 - 25 500 TONE
 - 26 500 TONE
 - 27 500 TONE
 - 28 500 TONE
 - 29 500 TONE
 - 30 500 TONE

- A-C OPERATION**
- 1 FILAMENT-0-3VAC
 - 2 FILAMENT-0-3VAC
 - 3 ALL OTHER CONNECTIONS REMAIN AS IN D-C OPERATION.

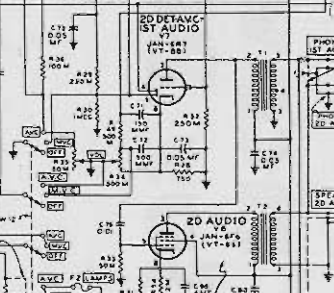
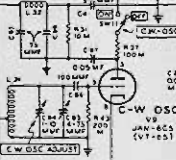
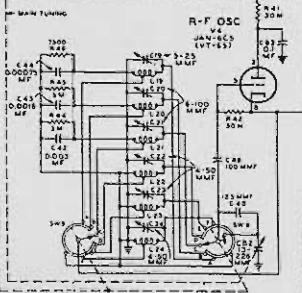
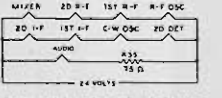

TUBE SOCKET TERMINALS, BOTTOM VIEW

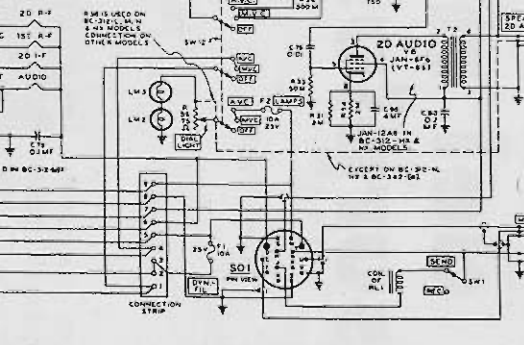
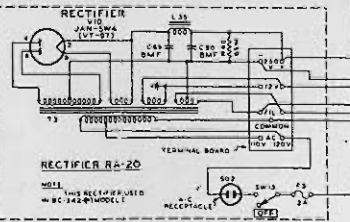
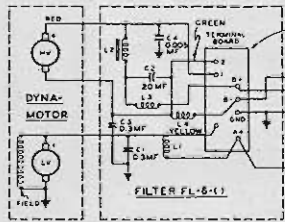

1171

3 0