

CHANGE }  
NO. 4 }

HEADQUARTERS  
DEPARTMENT OF THE ARMY  
WASHINGTON, D.C., 28 December 1976

**Operator's and Organizational  
Maintenance Manual Including Repair Parts  
and Special Tools List  
TEST HARNESS, RADIO SET AN/URM-157  
(NSN 6625-00-766-4685)  
AND AN/URM-157A  
(NSN 6625-00-236-1557)**

TM 11-6625-622-12, 10 December 1964, is changed as follows:

The title is changed as indicated above.

Page 3, paragraph 1-3. Delete subparagraphs *b* and *c* and substitute:

*b. Report of Packaging and Handling Deficiencies.* Fill out and forward DD Form 6 (Packaging Improvement Report) as prescribed in AR 700-58/NAVSUPINST 4030.29/AFR71-13/MCO P4030.29A, and DSAR 4145.8.

*c. Discrepancy in Shipment Report (DISREP) (SF 361).* Fill out and forward Discrepancy in Shipment Report (DISREP) (SF361) as prescribed in AR 55-38/NAVSUPINST 4610.33A/AFR 75-18/MCO P4610.19B, and DSAR 4500.15.

Paragraph 1-3-1. Delete paragraph 1-3.1 and substitute:

**1-3.1. Reporting of Errors**

The reporting of errors, omissions, and recommendations for improving this publication by the individu-

al user is encouraged. Reports should be submitted on DA Form 2028 (Recommended Changes to Publications and Blank Forms) and forwarded direct to Commander, US Army Electronics Command, ATTN: DRSEL-MA-Q Fort Monmouth, NJ 07703.

**1-3.2. Reporting Equipment Improvement Recommendations (EIR)**

EIR will be prepared using DA Form 2407 (Maintenance Request). Instructions for preparing EIR's are provided in TM 38-750, the Army Maintenance Management System. EIR's should be mailed directly to Commander, US Army Electronics Command, ATTN: DRSEL-MA-Q, Fort Monmouth, NJ 07703. A reply will be furnished directly to you.

Page 25, appendix II. Delete appendix II and substitute:

**APPENDIX II  
MAINTENANCE ALLOCATION**

**Section I. INTRODUCTION**

**A2-1. General**

This appendix provides a summary of the maintenance operations for AN/URM-157 and AN/URM-157A. It authorizes categories of maintenance for specific maintenance functions on reparable items and components and the tools and equipment required to perform each function. This appendix may be used as an aid in planning maintenance operations.

**A2-2. Maintenance Function**

Maintenance functions will be limited to and defined as follows:

*a. Inspect.* To determine the serviceability of an item by comparing its physical, mechanical, and/or electrical characteristics with established standards through examination.

*b. Test.* To verify serviceability and to detect incipient failure by measuring the mechanical or electrical

This reprint contains the basic  
publication dated 10 December 1964  
and changes 1 through 4.

cal characteristics of an item and comparing those characteristics with prescribed standards.

*c. Service.* Operations required periodically to keep an item in proper operating condition, i.e., to clean, preserve, drain, paint, or to replenish fuel/lubricants/hydraulic fluids or compressed air supplies.

*d. Adjust.* Maintain within prescribed limits by bringing into proper or exact position, or by setting the operating characteristics to the specified parameters.

*e. Align.* To adjust specified variable elements of an item to about optimum or desired performance.

*f. Calibrate.* To determine and cause corrections to be made or to be adjusted on instruments or test measuring and diagnostic equipment used in precision measurement. Consists of the comparison of two instruments, one of which is a certified standard of known accuracy, to detect and adjust any discrepancy in the accuracy of the instrument being compared.

*g. Install.* The act of emplacing, seating, or fixing into position an item, part, module (component or assembly) in a manner to allow the proper functioning of the equipment/system.

*h. Replace.* The act of substituting a serviceable like-type part, sub-assembly, model (component or assembly) for an unserviceable counterpart.

*i. Repair.* The application of maintenance services (inspect, test, service, adjust, align, calibrate, replace) or other maintenance actions (welding, grinding, riveting, straightening, facing, remachining, or resurfacing) to restore serviceability to an item by correcting specific damage, fault, malfunction, or failure in a part, subassembly, module/component/assembly, end item or system. This function does not include the trial and error replacement of running spare type items such as fuses, lamps, or electron tubes.

*j. Overhaul.* That periodic maintenance effort (service/action) necessary to restore an item to a completely serviceable/operational condition as prescribed by maintenance standards (e.g., DMWR) in appropriate technical publications. Overhaul is normally the highest degree of maintenance performed by the Army. Overhaul does not normally return an item to like-new condition.

*k. Rebuild.* Consists of those services/actions necessary for the restoration of unserviceable equipment to a like-new condition in accordance with original manufacturing standards. Rebuild is the highest degree of material maintenance applied to Army equipment. The rebuild operation includes the act of

returning to zero those age measurements (hours, miles, etc) considered in classifying Army equipment/components.

### A2-3. Column Entries

*a. Column 1, Group Number.* Column 1 lists group numbers, the purpose of which is to identify components, assemblies, subassemblies and modules with the next higher assembly.

*b. Column 2, Component/Assembly.* Column 2 contains the noun names of components, assemblies, subassemblies, and modules for which maintenance is authorized.

*c. Column 3, Maintenance Functions.* Column 3 lists the functions to be performed on the item listed in column 2. When items are listed without maintenance functions, it is solely for purpose of having the group numbers in the MAC and RPSTL coincide.

*d. Column 4, Maintenance Category.* Column 4 specifies, by the listing of a "worktime" figure in the appropriate subcolumn(s), the lowest level of maintenance authorized to perform the function listed in column 3. This figure represents the active time required to perform that maintenance function at the indicated category of maintenance. If the number or complexity of the tasks within the listed maintenance function vary at different maintenance categories, appropriate "worktime" figures will be shown for each category. The number of task-hours specified by the "worktime" figure represents the average time required to restore an item (assembly, subassembly, component, module, end item or system) to a serviceable condition under typical field operating conditions. This time includes preparation time, troubleshooting time and quality assurance/quality control time in addition to the time required to perform the specific tasks identified for the maintenance functions authorized in the maintenance allocation chart. Subcolumns of column 4 areas follows:

C — Operator/Crew  
O - Organizational  
F - Direct Support  
H — General Support  
D - Depot

*e. Column 5, Tools and Equipment.* Column 5 specifies by code, those common tool sets (not individual tools) and special tools, test, and support equipment required to perform the designated function.

FEDERAL STOCK NUMBER	DESIGNATION BY MODEL	DESCRIPTION	UNIT OF ISSUE	EXP	QTY AUTH	ILLUSTRATION	
						FIGURE NO.	ITEM NO.
		AN/URM-157 (continued)					
5995-985-8174		CABLE ASSEMBLY, SPECIAL PURPOSE, ELECTRICAL CX-11045/URM-157		NX	1		W11
5995-985-8201		CABLE, SPECIAL PURPOSE, ELECTRICAL CX-8997/URM-157		NX	1		W1
5995-985-8199		CABLE ASSEMBLY, RF CG-2727/U		NX	1		
6625-766-3847		TEST HARNESS SUBASSEMBLY TS-1949/URM-157 (MAINTENANCE FLOAT)		NX	1		
		RUNNING SPARE ITEMS					
5920-281-0225		FUSE, CTG: 81349, F02A250V6AS			5		F4
5920-284-6795		FUSE, CTG: 81349, F04A10ROB			3		F1, 2, 3

## APPENDIX IV

### ORGANIZATIONAL REPAIR PARTS LIST

#### Section I. INTRODUCTION

##### A4-1. General

a. The appendix lists the quantities of repair parts authorized for organizational maintenance and constitutes a basis of requisitioning when the major item of equipment is authorized to the organization. These equipments are issued on the basis of allowance prescribed in equipment authorization tables and other documents which are a basis of requisitioning.

b. Columns areas follows:

- (1) *Federal stock number.* This column lists the 11-digit Federal stock number.
- (2) *Designation by model.* Not used.
- (3) *Description.* Nomenclature or the standard item name and brief identifying data for each item are listed in this column. When requisitioning, enter the nomenclature and description.
- (4) *Unit of issue.* The unit of issue is each unless otherwise indicated and is the supply term by which the individual item is counted for procurement, storage, requisitioning, allowances, and issue purposes.
- (5) *Expendability.* Nonexpendable items are indicated by NX. Expendable items are not annotated.
- (6) *Quantity incorporated in unit.* This column lists the quantity of each part found in a given assembly, component, or equipment.
- (7) *Organizational* The quantities indicated in this column are maximum levels of repair parts authorized to be kept on hand by units performing organizational maintenance. The quantities are based on 100 equipments to be maintained for a 15-day period.
- (8) *Illustration.* The "Item No." column lists the reference designations that appear on the part in the equipment. These same designations are also used on any illustrations of the equipment.

##### A4-2. Parts for Maintenance

When this equipment is used by signal service organizations organic to the theater headquarters or communication zones to provide theater communications, those repair parts authorized up to and including general support are authorized for stockage by the organization operating this equipment.

##### A4-3. Additional Repair Parts Authorization

An asterisk (\*) indicates that an item is not authorized for stockage but if required, maybe requisitioned for immediate use only.

##### A4-4. Manufacturer's Codes

Following is a list of manufacturer's codes and addresses:

<i>Code</i>	<i>Name and address</i>
00779	Amp, Inc. Harrisburg, Pa.
02660	Amphenol-Borg Electronics Corp. Broadview (Chicago), Ill.
04009	Arrow-Hart and Hegman Electric Co. Hartford, Conn.
04796	Sequoia Wire Co. Redwood City, Calif.
05973	American Super-Temperature Wires, Inc. Winooski, Vt.
06214	Atlas Spring and Manufacturing Co. Chicago, Ill.
08664	The Bristol Co. Waterbury, Conn.
08854	Lake Chemical Co. Chicago, Ill.
09190	Aluminum Co. of America Davenport, Iowa
09922	Burndy Corp. Norwalk, Conn.
13499	Collins Radio Co. Cedar Rapids Iowa
14674	Corning, (Glass Works Corning, N.Y.
15605	Cutler Hammer, Inc. Milwaukee, Wis.
17419	The Deutsch Co. Los Angeles, Calif.
24446	General Electric Co. Schenectady, N.Y.

	<i>Name and address</i>
	elps Dodge Copper Products Corp. New York, N.Y.
3021	Sangamo Electric Co. Springfield, Ill.
58474	Superior Electric Co. Bristol, Conn.
70008	Belden Manufacturing Co. Chicago, Ill.
71400	Bussmann Fuse Division of McGraw Edison Co. St. Louis, Mo.
71468	Cannon Electric Co. Los Angeles, Calif.
71590	Centralab Division of Globe Union, Inc. Milwaukee, Wis.
71984	Dow Corning Corp. Midland, Mich.
72794	Dzus Fastener Co., Inc. Babylon, N.Y.
72962	Elastic Stop Nut Corp. of America Union, N.J.
72962	Erie Resistor Corp. Erie, Pa.
72963	Essex Wire Corp. Fort Wayne, Ind.
74196	Heinemann Electric Co. Trenton, N.J.
74284	Skydyne, Inc. Port Jervis, N.Y.
74970	Johnson, E. F., Co. Waseca, Minn.
75882	Kulka Electric Manufacturing Co., Inc. Mount Vernon, N.Y.
76881	Minnesota Mining and Manufacturing Co. St. Paul, Minn. Millen, James, Manufacturing Co., Inc. Malden, Mass. Oak Manufacturing Co. Crystal Lake, Ill.
76892	Okonite Co. Passaic, N.J.
77147	Patton MacGuyver Co. Providence, R.I.
77820	Scintilla Division of Bendix Aviation Corp. Sidney, N.Y.
77860	Sherman HB Manufacturing Co. Battle Creek, Mich.
77902	Rohm and Haas Co. Philadelphia, Pa.
78189	Shakproof Division of Illinois Tool Works Elgin, Ill.
78553	Tinnerman Products Inc. Cleveland, Ohio
78731	Thiokol Chemical Corp. Bristol, Pa.
80058	Joint Electronic Type Designation System
80802	Multi Electrical Manufacturing Co. Chicago, Ill.
81348	Military Specifications
81350	Joint Army-Navy Specifications
81851	Bentley Harris Manufacturing Co. Conshohocken, Pa.

<i>Code</i>	<i>Name and address</i>
82110	Gudebrod Bros. Silk Co. Philadelphia, Pa.
82142	Jeffers Electronics Division of Speer Carbon Co. DuBois, Pa.
82383	Sun Electric Corp. Chicago, Ill.
82389	Switchcraft, Inc. Chicago, Ill.
83501	Gavitt Wire and Cable Co., Division of Amerace Corp. Brookfield, Mass.
86797	Rogan Bros. Skokie, Ill.
87666	Vlerner Hyman and Sons Richmond, Va.
88044	Aeronautical Standards Group Department of Navy and Air Force Washington, D.C.
90484	Suprenant Manufacturing Co. Clinton, Mass.
92054	Radio Cores, Inc. Oak Lawn, Ill.
92607	Tensolite Insulated Wire Co., Inc. Tarrytown, N.Y.
92825	Whitso, Inc. Chicago, Ill.
92844	Jones Dabney Co. Detroit, Mich.
94630	Ferro Corp. Cleveland, Ohio
96881	Precision Drawn Steel Co. Camden, N.J.
96906	Military Standards

#### A4-5. Requisitioning Information

a. The allowance factors are based on 100 equipments. In order to determine the number of parts authorized for the specific number of equipments supported, the following formula will be used and carried out to two decimal places.

Specific number of equipments supported

$$\times \frac{\text{allowance factor}}{100}$$

==number of parts authorized.

b. Fractional values obtained from above computation will be rounded to whole number as follows:

- (1) When the total number of parts authorized is less than one, the quantity authorized will be one.
- (2) For all values above one, fractional values below 0.5 will revert to the next lower number, fractional values of 0.5 or larger will advance to the next higher whole number.

*c.* The number of parts authorized determined after application of *a* and *b* above, represent one prescribed load for a 15-day period. The items and computed quantities thereof must be on hand or on order at all times.

*d.* Major commanders will determine the number of prescribed loads organizational units will

carry. Units and organizations authorized additional prescribed loads will utilize the formula explained in *a* above but will multiply the number of equipments supported by the number of authorized prescribed loads before completing the formula. Fractional values will be rounded to whole numbers as described above.

## SECTION II. ORGANIZATIONAL FUNCTIONAL PARTS LIST

FEDERAL STOCK NUMBER	DESIGNATION BY MODEL	DESCRIPTION	UNIT OF ISSUE	EXP	QTY IN UNIT	ORGANIZATIONAL	ILLUSTRATION	
							FIGURE NO.	ITEM NO.
6625-766-4685		TEST HARNESS, RADIO SET AN/URM-157		NX				
		GROUP I CABLE ASSEMBLY, SPECIAL PURPOSE, ELECTRICAL BRANCHED CX-8998/URM-157						
5995-797-7299		CABLE ASSEMBLY, SPECIAL PURPOSE, ELECTRICAL, BRANCHED CX-8998/URM-157		NX	1			W2
		NO PARTS AUTHORIZED FOR STOCKAGE AT ORGANIZATIONAL LEVEL						
		GROUP II CABLE ASSEMBLY, SPECIAL PURPOSE ELECTRICAL CX-11046/URM-157						
5995-985-8167		CABLE ASSEMBLY, SPECIAL PURPOSE ELECTRICAL EX-11046/URM-157		NX	1			W12
5920-281-0225		FUSE, CTG: 81349, F02A250V6AS			5	13.0		F4
5920-284-6795		FUSE, CTG: 81349, F04A10ROB (Authorized allowances based on a total of 4.)			3	1.4		F1, 2, 3
		GROUP III CABLE ASSEMBLY, SPECIAL PURPOSE ELECTRICAL CX-9001/URM-157						
5995-985-8181		CABLE ASSEMBLY, SPECIAL PURPOSE ELECTRICAL CX-9001/URM-157		NX	1			W4
		NO PARTS AUTHORIZED FOR STOCKAGE AT ORGANIZATIONAL LEVEL						
		GROUP IV CABLE ASSEMBLY, SPECIAL PURPOSE, ELECTRICAL CX-9002/URM-157						
5995-985-8178		CABLE ASSEMBLY, SPECIAL PURPOSE, ELECTRICAL CX-9002/URM-157		NX	1			W5
		NO PARTS AUTHORIZED FOR STOCKAGE AT ORGANIZATIONAL LEVEL						
		GROUP V CABLE ASSEMBLY, SPECIAL PURPOSE, ELECTRICAL CX-9004/URM-157						
5995-985-8176		CABLE ASSEMBLY, SPECIAL PURPOSE, ELECTRICAL CX-9004/URM-157		NX	1			W7
		NO PARTS AUTHORIZED FOR STOCKAGE AT ORGANIZATIONAL LEVEL						
					1			W6

FEDERAL STOCK NUMBER	DESIGNATION BY MODEL	DESCRIPTION	UNIT OF ISSUE	EXP	QTY IN UNIT	ORGANIZATIONAL	ILLUSTRATION	
							FIGURE NO.	ITEM NO.
		AN/URM-157 (continued)						
5995-985-8177		<p>GROUP VI CABLE ASSEMBLY, SPECIAL PURPOSE, ELECTRICAL CX-9003/URM-157</p> <p>CABLE ASSEMBLY, SPECIAL PURPOSE, ELECTRICAL CX-9003/URM-157</p> <p>NO PARTS AUTHORIZED FOR STOCKAGE AT ORGANIZATIONAL LEVEL</p>		NX	1			W6
5995-985-8182		<p>GROUP VII CABLE ASSEMBLY, SPECIAL PURPOSE, ELECTRICAL CX-9005/URM-157</p> <p>CABLE ASSEMBLY, SPECIAL PURPOSE, ELECTRICAL CX-9005/URM-157</p> <p>NO PARTS AUTHORIZED FOR STOCKAGE AT ORGANIZATIONAL LEVEL</p>		NX	1			W8
5995-985-8179		<p>GROUP VIII CABLE ASSEMBLY, SPECIAL PURPOSE, ELECTRICAL CX-8999/URM-157</p> <p>CABLE ASSEMBLY, SPECIAL PURPOSE, ELECTRICAL CX-8999/URM-157</p> <p>NO PARTS AUTHORIZED FOR STOCKAGE AT ORGANIZATIONAL LEVEL</p>		NX	1			
5995-985-8180		<p>GROUP IX CABLE ASSEMBLY, SPECIAL PURPOSE ELECTRICAL CX-9000/URM-157</p> <p>CABLE ASSEMBLY, SPECIAL PURPOSE ELECTRICAL CX-9000/URM-157</p> <p>NO PARTS AUTHORIZED FOR STOCKAGE AT ORGANIZATIONAL LEVEL</p>			1			W3
5995-985-8183		<p>GROUP X CABLE ASSEMBLY, SPECIAL PURPOSE, ELECTRICAL CX-9006/URM-157</p> <p>CABLE ASSEMBLY, SPECIAL PURPOSE, ELECTRICAL CX-9006/URM-157</p> <p>NO PARTS AUTHORIZED FOR STOCKAGE AT ORGANIZATIONAL LEVEL</p>		NX	1			W9
5995-985-8168		<p>GROUP XI CABLE ASSEMBLY, SPECIAL PURPOSE, ELECTRICAL CX-11044/URM-157</p> <p>CABLE ASSEMBLY, SPECIAL PURPOSE, ELECTRICAL CX-11044/URM-157</p> <p>NO PARTS AUTHORIZED FOR STOCKAGE AT ORGANIZATIONAL LEVEL</p>		NX	1			W10



FEDERAL STOCK NUMBER	DESIGNATION BY MODEL	DESCRIPTION	UNIT OF ISSUE	EXP	QTY IN UNIT	ORGANIZATIONAL	ILLUSTRATION	
							FIGURE NO.	ITEM NO.
		AN/URM-157 (continued)						
5995-985-8174		GROUP XII CABLE ASSEMBLY, SPECIAL PURPOSE, ELECTRICAL CX-11045/URM-157 CABLE ASSEMBLY, SPECIAL PURPOSE, ELECTRICAL CX-11045/URM-157 NO PARTS AUTHORIZED FOR STOCKAGE AT ORGANIZATIONAL LEVEL		NX	1			W11
5995-985-8201		GROUP XIII CABLE, SPECIAL PURPOSE, ELECTRICAL CX-8997/URM-157 CABLE, SPECIAL PURPOSE, ELECTRICAL CX-8997/URM-157 NO PARTS AUTHORIZED FOR STOCKAGE AT ORGANIZATIONAL LEVEL		NX	1	*		W1
5995-985-8199		GROUP XIV CABLE ASSEMBLY, RF CG-2727/U CABLE ASSEMBLY, RF CG-2727/U NO PARTS AUTHORIZED FOR STOCKAGE AT ORGANIZATIONAL LEVEL		NX	1			
6625-766-3847		GROUP XV TEST HARNESS SUBASSEMBLY TS-1949/URM-157 TEST HARNESS SUBASSEMBLY TS-1949/URM-157 (MAINTENANCE FLOAT)		NX	1			
5920-284-6795		FUSE, CARTRIDGE: 81349, FO4A1OROB (For authorized allowances see Group II.)						F4
5920-296-0679		FUSE, CARTRIDGE: 81349, FO3G5ROOA			3	9.4		F1-3
5355-971-0588		KNOB: 13499, 543-8039-00			1	*		

By Order of the Secretary of the Army:

HAROLD K. JOHNSON,  
*General, United States Army,*  
*Chief of Staff.*

**Official:**

J. C. LAMBERT,  
*Major General, United States Army,*  
*The Adjutant General.*

**Distribution:**

To be distributed in accordance with DA Form 12-36 (unclas) requirements for Direct and General Support Maintenance Literature for CH-34C, CH-37B, CH-47A, CV-2A, CV-2B, CV-7A, OV-1A, OV-1B, OV-1C, U-1A, U-6A, U-8F, UH-1B and UH-1D aircraft.

CHANGE }  
No. 3 }

HEADQUARTERS  
DEPARTMENT OF THE ARMY  
WASHINGTON, D.C., 17 December 1973

**Operator's and Organizational Maintenance Manual  
Including Repair Parts and Special Tools List  
TEST HARNESS, RADIO SET AN/URM-157 AND AN/URM-157A**

TM 11-6625-622-12, 10 December 1964, is changed as follows:

Page 3. Delete paragraph 1-2 and substitute:

**1-2. Indexes of Publications**

a. *DA Pam 310-4.* Refer to the latest issue of DA Pam 310-4 to determine whether there are new editions, changes or additional publications pertaining to the equipment.

b. *DA Pam 310-7.* Refer to DA Pam 310-7 to determine whether there are modification work orders (MWO's) pertaining to the equipment.

Delete paragraph 1-3 and substitute:

**1-3. Forms and Records**

a. *Reports of Maintenance and Unsatisfactory Equipment.* Maintenance forms, records, and reports which are to be used by maintenance personnel at all maintenance levels are listed in and prescribed by TM 38-750.

b. *Report of Packaging and Handling Deficiencies.* Fill out and forward DD Form 6 (Report of Packaging and Handling Deficiencies) as

prescribed in AR 700-58 (Army)/NAVSUP PUB 378 (Navy)/AFR 71-4 (Air Force)/and MCO P4030.29 (Marine Corps).

c. *Discrepancy in Shipment Report (DISREP) (SF361).* Fill and forward Discrepancy in Shipment Report (DISREP) (SF 361) as prescribed in AR 55-38 (Army)/NAVSUP PUB 459 (Navy)/AFM 75-34 (Air Force)/and MCO P4610.19 (Marine Corps).

**1-3.1. Reporting of Equipment Publication Improvements**

The reporting of errors, omissions, and recommendations for improving this publication by the individual user is encouraged. Reports should be submitted on DA Form 2028 (Recommended Changes to Publications,) and forwarded direct to Commander, US Army Electronics Command, ATTN: AMSEL-MA-C, Fort Monmouth, 07703.

Page 4. After paragraph 1-6, add:

**1-6.1. Items Comprising an Operable Equipment**

PSN	Qty	Nomenclature, part No., and mfr code	Fig No.
		Test Harness, Radio Set AN/URM-157 consisting of: NOTE The part number is followed by the applicable 5-digit Federal supply code for manufacturers (FSCM) identified in SB 708-42 and used to identify manufacturer, distributor, or Government agency, etc.	1-1
5821-953-2209	1	Control, Radio Set C-3940U/ARC-94: manual control type power requirements 27.5 vdc; 3600 max range of indicator knee 4.875 in. lg by 5.750 in. w by 2.625 in. h o/a; panel mounted; 522-2457-60; 13499	
6625-766-3847	1	Test Harness Subassembly TS-1949/URM-157: controls power to Radio Sets AN/ARC-102 and AN/MRC-95 while under test. When necessary cable are added, provides interconnecting facilities for the components of AN/ARC 102 and AN/MRC-95 during test; 548-8292-005 M5AD1-A13; 13499 which includes:	

FSN	Qty	Nomenclature, part No., and mfr code	Fig.No.
5935-258-7429	2	Adapter UG-201/A/U: 357-9291-00; 13499	1-4
5995-985-8199	1	Cable Assembly, Radio Frequency CG-2727/U: plug UG-88E/U on each end; 5 ft; 549-4334-002 M5AD1-A12; 13499	1-4
5995-985-8201		Cable Assembly, Special Purpose, Electrical CX-8997/URM-157: provides interconnecting facilities from the Receiver-Transmitter, Radio RT-698/ARC-102 to the Test Harness Subassembly TS-1949/URM-157; 548-8002-004 M5AD1-A11; 13499	1-3
5995-797-7299	1	Cable Assembly, Power, Electrical, Branched CX-8998/ URM-157: provides 28 vdc power to the Test Harness, Subassembly TS-1949/URM-157; 761-4969-001 M5AD1-A15; 13499	1-3
5995-985-8179		Cable Assembly, Special purpose, Electrical CX-8999/URM-157: provides interconnecting facilities from the Test Harness Subassembly TS-1949/URM-157 to the 115v 1 ph 400 Hz power source; 548-8035-002 M5AD1-A8; 13499	1-3
5995-985-8180		Cable Assembly, Special Purpose, Electrical CX-9000/URM-157: connects Power Supply Collins type 516H-1 to the Test Harness Subassembly TS-1949/RUM-157 548-8003-004 M5AD1-A9; 13499	1-3
5995-985-8181		Cable Assembly, Special Purpose, Electrical CX-9001/URM-157; connects Radio Set Controls Collins type 714E-1 or 5-2 to the Test Harness Subassembly TS-1949/URM-157; 548-8029-004 M5AD1-A4; 13499	1-3
5995-985-8178		Cable Assembly, Special Purpose, Electrical CX-9002/URM-157: provides interconnecting facilities from the Control, Radio Set C-3940/ARC-94 to the Test Harness Subassembly TS-1949/URM-157; 548-8284-004 M5AD1-A14; 13499	1-3
5995-985-8177		Cable Assembly, Special Purpose, Electrical CX-9003/URM-157: provides interconnecting facilities from the Antenna Coupler Collins type 180R-5 to the Test Harness Subassembly TS-1949/URM-157 when a Collins type 180R-5 is used; 548-8285-004 M5AD1A6; 13499	1-3
5995-985-8176	1	Cable Assembly, Special Purpose, Electrical CX-9004/URM-157: provides interconnecting facilities from the Control, Antenna Coupler C-4832/TSW to the Test Harness Subassembly TS-1949/URM-157; 548-8286-004 M5AD1-A5; 13499	1-4
5995-985-8182	1	Cable Assembly, Special Purpose, Electrical CX-9005/URM-157: provides interconnecting facilities from the Coupler, Antenna CU-1150/ARA-41 to the Test Harness Subassembly TS-1949/URM-157; 548-8287-004 M5AD1-A7; 13499	1-4
5995-985-8183	1	Cable Assembly, Special Purpose, Electrical CX-9006/URM-157: provides interconnecting facilities between the Coupler, Antenna CU-351/AR and the Test Harness Sub- assembly TS-1949/TS-1949/URM-157; 554-2914-004 M5AD1-A10; 13499	1-4
		Cable Assembly, Special Purpose, Electrical CX-1104/ URM-157: provides interconnecting facilities from the controls of the Radio Set AN/MRC-95 to the Test Harness Subassembly TS-1949/URM-157; 761-4970-001 M5AD1-A16; 13499	1-4
5995-985-8174		Cable Assembly, Special Purpose, Electrical CX-11046/URM-157: provides interconnecting facilities the Power Inverter-Mounting PP-3702/ARC-102 to the Test Harness Subassembly TS-1949/RUM-157; 756-5248-004 M5AD1-A2; 13499	1-4
5995-985-8167		Cable Assembly, Special Purpose, Electrical CX-11046/URM- 157: provides interconnecting facilities from the Power Inverter-Mounting PP-3702/ARC-102 to the Test Harness Subassembly TS-1949/RUM-157; 756-5248-004 M5AD1-A2; 13499	

## **A2-4. Tool and Test Equipment Requirements (Table 1)**

*a. Tool or Test Equipment Reference Code.* The numbers in this column coincide with the numbers used in the tools and equipment column of the MAC. The numbers indicate the applicable tool or test equipment for the maintenance functions.

*b. Maintenance Category.* The codes in this column indicate the maintenance category allocated the tool or test equipment.

*c. Nomenclature.* This column lists the noun name and nomenclature of the tools and test equipment required to perform the maintenance functions.

*d. National/NATO Stock Number.* This column lists the National/NATO stock number of the specific tool or test equipment.

*e. Tool Number.* This column lists the manufacturer's part number of the tool followed by the Federal Supply Code for Manufacturers (5-digit) in parentheses.



## APPENDIX III BASIC ISSUE ITEMS LIST (BIIL) AND ITEMS TROOP INSTALLED OR AUTHORIZED LIST (ITIAL)

### Section I. INTRODUCTION

#### 1. Scope

This appendix lists only basic issue items required by the crew/operator for installation, operation, and maintenance of Test Harness, Radio Set AN/URM-157.

#### 2. General

This Basic Issue Items Troop Installed or Authorized List is divided into the following sections:

*a. Basic Issue Items List — Section II.* A list, in alphabetical sequence, of items which are furnished with, and which must be turned in with the end item.

*b. Items Troop Installed or Authorized List — Section III.* Not applicable.

#### 3. Explanation of Columns

The following provides an explanation of columns found in the tabular listings:

*a. Illustration.* This column is divided as follows:

(1) *Figure Number.* Indicates the figure number of the illustration in which the item is shown.

(2) *Item Number.* Not applicable.

*b. Federal Stock Number.* Indicates the Federal stock number assigned to the item and will be used for requisitioning purposes.

*c. Part Number.* Indicates the primary number used by the manufacturer (individual, company, firm, corporation, or Government activity), which controls the design and characteristics of the item by means of its engineering drawings, specifications standards, and inspection requirements, to identify an item or range of items.

*d. Federal Supply Code for Manufacturer (FSCM).* The FSCM is a 5-digit numeric code used to identify the manufacturer, distributor, or Government agency, etc., and is identified in SB 708-42.

*e. Description.* Indicates the Federal item name and a minimum description required to identify the item.

*f. Unit of Measure (UM).* Indicates the standard of basic quantity of the listed as used in performing the actual maintenance function. This measure is expressed by a two-character alphabetical abbreviation, (e.g., ea, in, pr, etc.). When the unit of measure differs from the unit of issue, the lowest unit of issue that will satisfy the required units of measure will be requisitioned.

*g. Quantity Furnished with Equipment (Basic Issue Items Only).* Indicates the quantity of the basic issue item furnished with the equipment.

### Section II. BASIC ISSUE ITEMS LIST

(1) Illustration		(2) Federal stock number	(3) Part number	(4) FSCM	(5) Description Usable on code	(6) Unit of meas	(7) Qty furn with equip
(A) Fig. No.	(B) Item No.						
1-1		6625-766-3676	625300 021-0257-00 M5AD1-A3	74284	CASE, TEST HARNESS CY-4064/URM-157; PROVIDES FOR STORAGE AND TRANSIT OF TEST HARNESS, RADIO SET AN/UMR- 157		

By Order of the Secretary of the Army:

CREIGHTON W. ABRAMS  
*General, United States Army*  
*Chief of Staff*

Official:

VERNE L. BOWERS  
*Major General, United States Army*  
*The Adjutant General*

Distribution:

To be distributed in accordance with DA Form 12-36A, Section II (qty rqr block No. 1028)  
Organizational Maintenance requirements for AN/URM-157.



Change }  
No. 2 }

HEADQUARTERS  
DEPARTMENT OF THE ARMY  
Washington, D.C., 30 March 1972

**Operator's and  
Organizational Maintenance Manual Including Repair Parts and  
Special Tools List  
TEST HARNESS, RADIO SET AN/URM-157 AND AN/URM-157A**

TM 11-6625-622-12, 10 December 1964, is changed as follows:

This manual is changed to include the following equipment.

Nomenclature	Order No.	Serial No.
Test Harness, Radio Set AN/URM-157A	DAAB05-70-A-0156-0007	0937A through 0986A

Change the title of the manual as shown above.

**Page 3.** Make the following changes:  
Below the title add: *Note.* Test Harness, Radio Set AN/URM-157A is similar to Test Harness, Radio Set AN/URM-157. Information in this manual applies to both sets unless otherwise specified.

**Paragraph 1-1.** Delete the first sentence and substitute: This manual describes Test Harness, Radio Set AN/URM-157 (fig. 1-1) (Collins type 678P-2) and Test Harness, Radio Set AN/URM-157A (Collins type 678P-2B), and covers their operation and organizational maintenance.

**Paragraph 1-4, subparagraph a, line 4.** After "(678P-2)" add "and Test Harness, Radio Set AN/URM-157A (Collins type Test Harness 678P1-B and transit case, which together are designated a 678P-2B)."

**Page 5, Paragraph 1-7.** Make the following changes:

Chart, line 2. After "AN/URM-157" add "or AN/URM-157A."

Chart, line 6. After "TS-1949/URM-157" add "or TS-1949A/URM-157."

At the bottom of the chart add:

Nomenclature	Common Name
Cable Assembly, Power, Electrical Branched CX-12612/URM-157A	Dc power
Cable Assembly, Special Purpose, Electrical CX-10594/URM-157	Cable W13

**Paragraph 1-8.** Make the following changes:  
**Heading.** After "TS-1949/URM-157" add "and TS-1949A/URM-157."

**First sentence:** Delete sentence and substitute: The test units (figures 1-2 and 1-2.1) are intended for use while mounted in their fiberglass carrying case.

Lines 8 and 9. Change "The test unit" to "The TS-1949/URM-157."

Line 11. After "transceivers" add "The TS-1949A/URM-157 includes controls and connectors for use in testing the Collins type 618T-1/1B and 618T-2/2B transceivers."

**Paragraph 1-9b (z).** After "Cable W2." add "(AN/URM-157 only)."

**Page 6.** Make the following changes:  
**Paragraph 1-9b (10).** After "Cable W10." add "(AN/URM-157 only)."

Paragraph 1-9b (11). After "Cable W11." add "(AN/URM-157 only)."  
 Figure 1-2. Delete the caption and substitute: Test

Harness Subassembly, TS-1949/URM-157 and control unit.  
 Add figure 1-2.1 after figure 1-2.

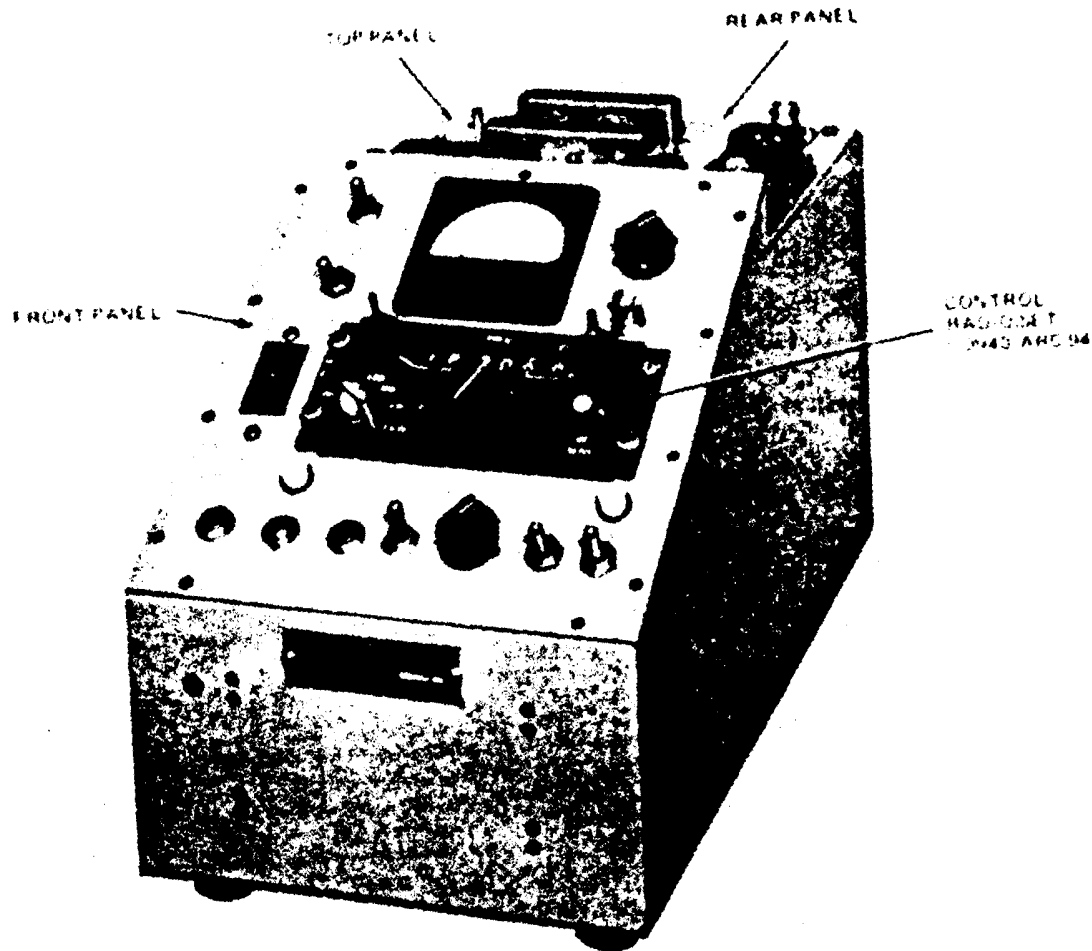

EL6625-622-12-C2-TM-11

Figure 1-2.1. Test Harness Subassembly, TS-1949A/URM-157 and control unit.

Page 7. Make the following changes.  
 Paragraph 1-9b (12). After "Cable W12." add "(AN/URM-157 only)."

Add the following after subparagraph (15):

(16) Cable W13. Cable W13 is an 8-conductor, rubber-covered cable, 5 feet long, with a 41-pin male connector on one end and a 26-pin female connector on the other end.

(17) Dc power cable. (AN/URM-157A only). The dc power cable is a four-conductor, rubber-covered cable, 5 feet long, with a four-pin female connector on one end and four lugs or pin female connector on the other.

Paragraph 1-9c. Delete and substitute:  
 c. Running spares (figures 1-4 and 1-4.1). The following fuses are included as running spares:

Fuse	Quantity	
	AN/URM-157	AN/URM-157
115 volts, 5 amperes	5	5
28 volts, 10 amperes	3	5

Figure 1-3. Delete the caption and substitute AN/URM-157 cables. Add figure 1-3.1 after figure 1-3.

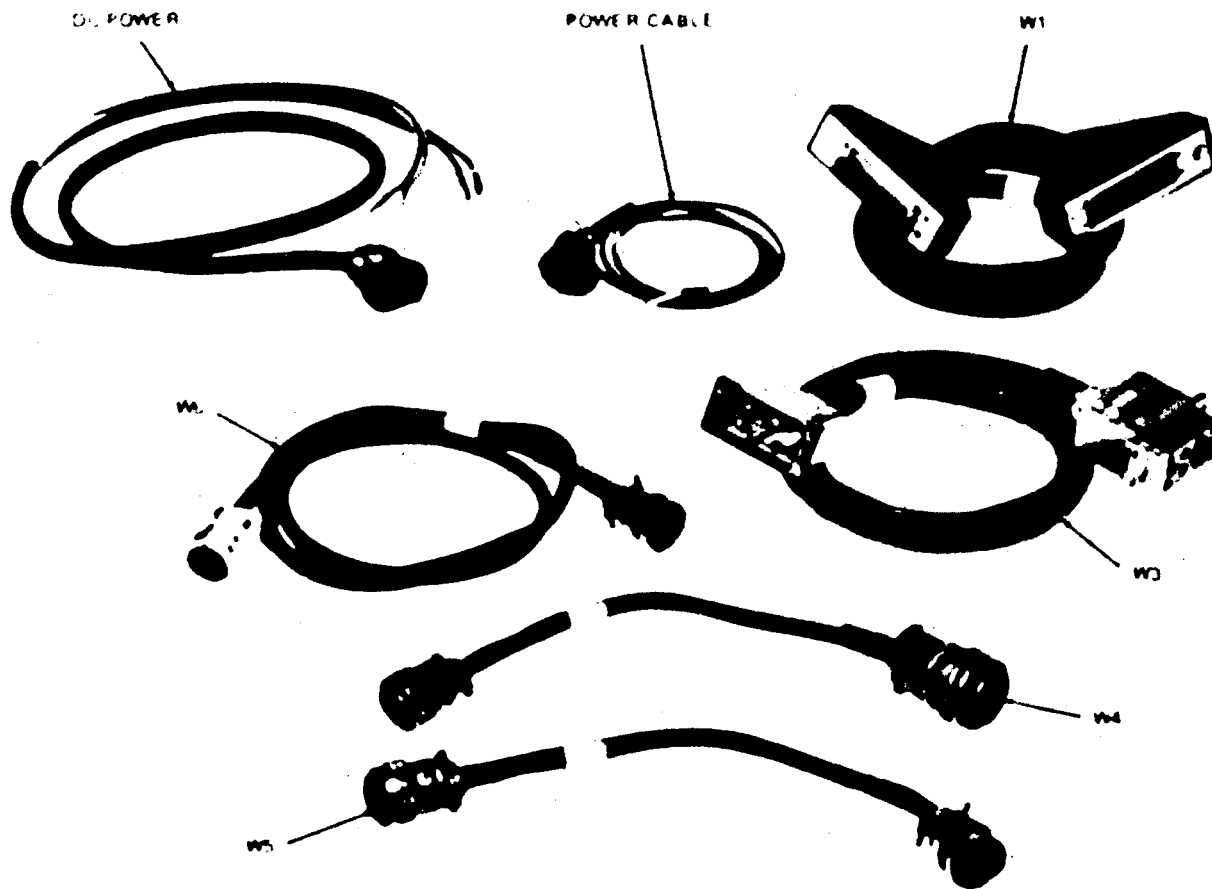

EL6625-622-12-C2-TM-12

Figure 1-3.1 AN/URM-157A cables.

Page 8. Make the following changes.

Figure 1-4. Delete figure 1-4 and substitute new figure 1-4:

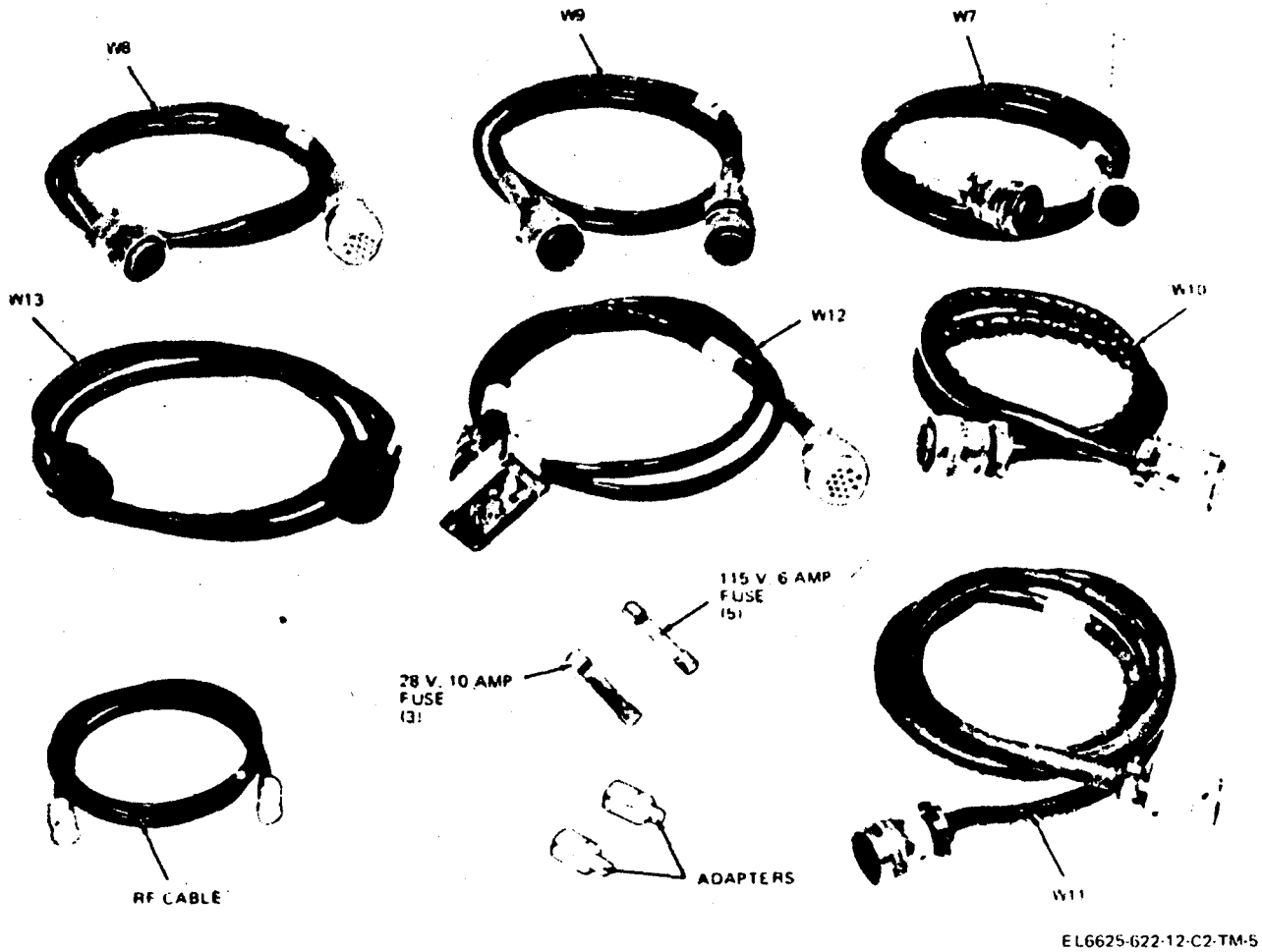
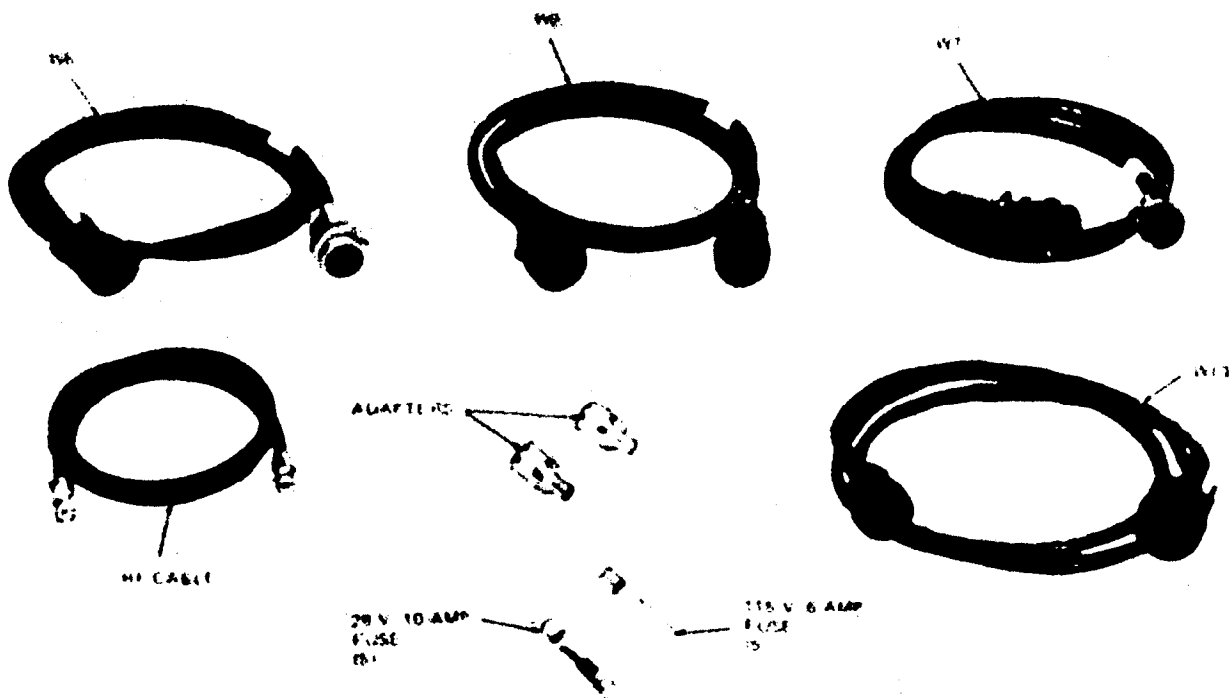

Figure 1-4. AN/URM-157 cables, adapters, and spare fuses.

Add figure 1-4.1 after figure 1-4.



EL6625-622-12-C2-TM-13

Figure 1-4.1 AN/URM-157A cables, adapters, and spare fuses.

Page 11. Make the following changes:

Paragraph 2-3a. After "Front Panel" delete (fig. 2-2) and substitute (figures 2-2 and 2-2.1)

Chart, "Control, indicator or connector" column.

Make the following changes:

Line 1. After "618T-2-OFF-618T-3" add "or 618T-2/2B-OFF-618T-3/3B."

Line 2. After "618T-3" add "or 618T-3/3B."

Chart, "Function" column. Make the following changes:

Line 4. After "618T-2" add "or 618T-2/2B."

Line 6. After "618T-3" add "or 618T-3/3B."

Line 8. After "618T-2/3" add "or 618T-2/2B/3/3B."

Page 12. Make the following changes:

Chart, "Control, indicator or connector" column.

Make the following changes:

Line 1, after "CW KEY" add "or CW."

Line 2. Delete line and substitute 714E-1-714E-2/3 switch (2-position toggle) or 714E-1-714E-2/3-714E-6 (3-position rotary wafer switch)

Line 3. After "300ΩAUDIO LOAD:" add "or AUDIO LOAD"

Chart, "Function" column, below "714E-2/3" in Switch position column add: 614E-6.

Chart, "Function" column, below "Connects the C-3940/ARC-94 (714E-3) to the receiver-transmitter." In Action column add "Not used."

Page 14. Make the following changes:

Figure 2-2, caption. Change "Test unit" to TS-1949/URM-157.

Add figure 2-2.1 after figure 2-2.

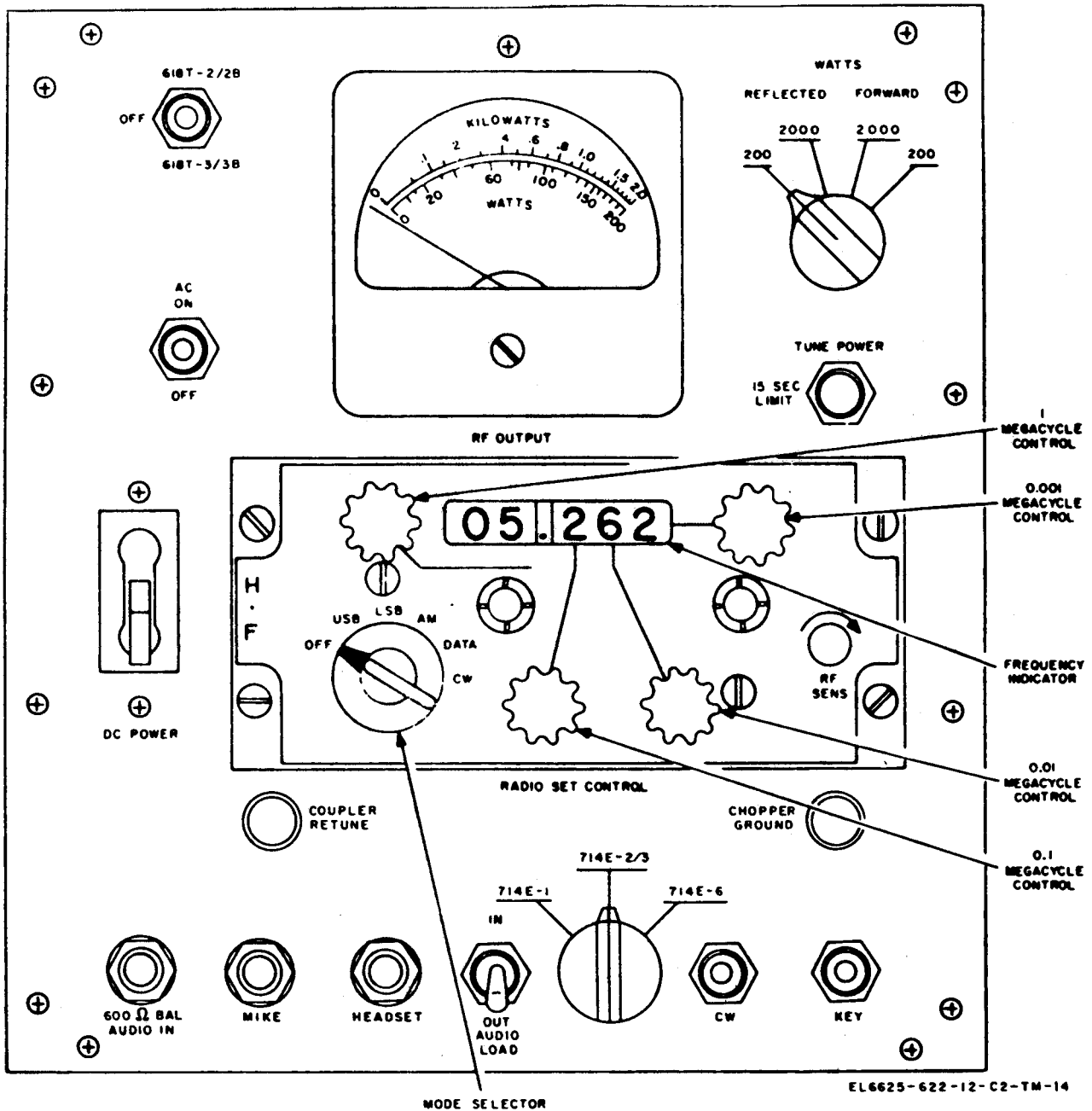
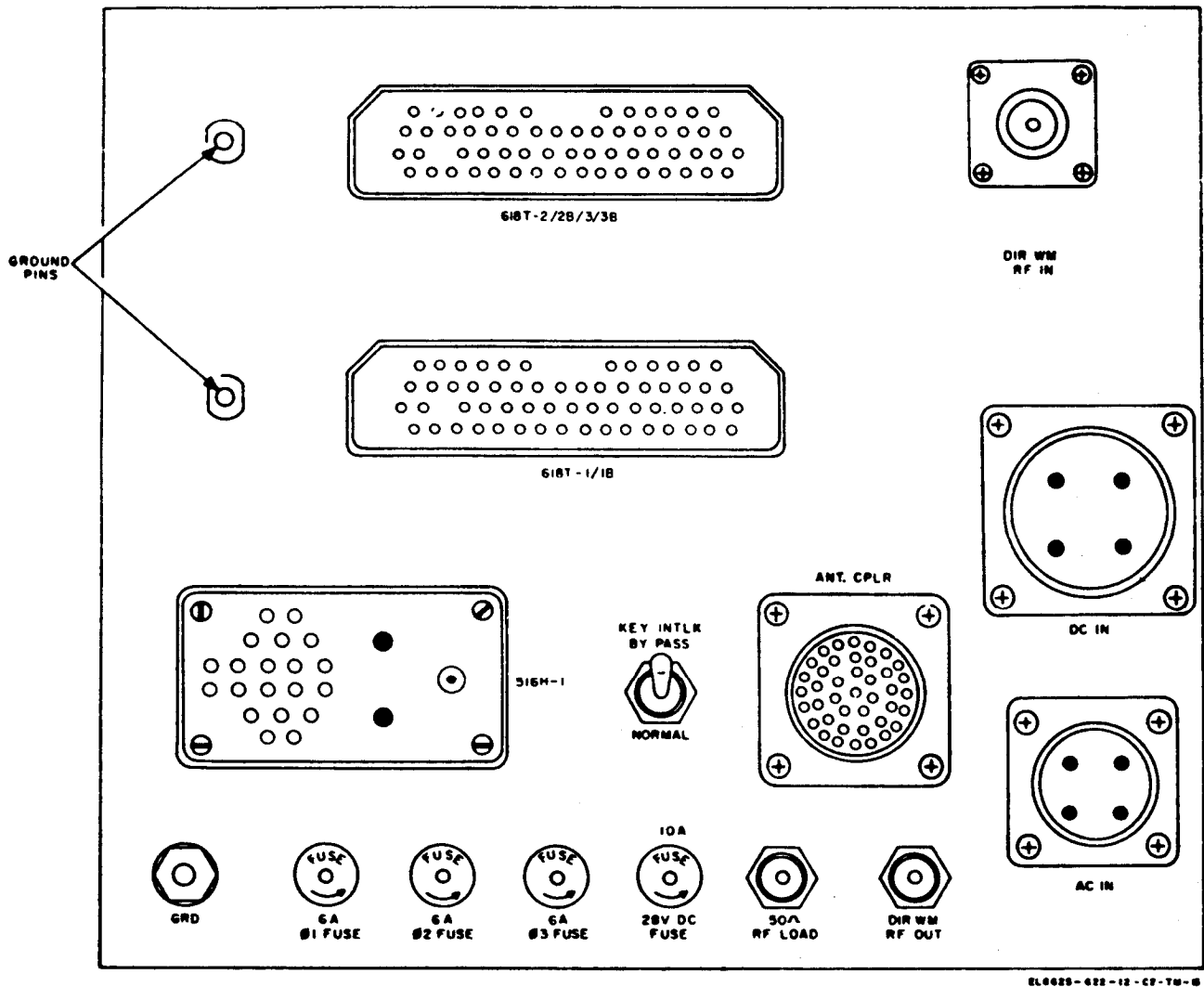

Figure 2-2.1 TS-1949A/URM-157 front panel operating controls, indicators, and connectors.

Page 15. Make the following changes:  
 Paragraph 2-3c. After "Top Panel" delete (fig. 2-3) and substitute (figures 2-3 and 2-3.1).  
 Chart, "Control or connector" column. Make the following changes:  
 Line 1. After "618T-2/3" add "or 618T-2/2B/3/3B."

Line 2. After "618T-1" add "or 618T-1/1B."

Page 16. Make the following changes:  
 Figure 2-3, caption. Change "Test unit" to "TS-1949/URM-157."  
 Add figure 2-3.1 after figure 2-3.



EL0025-022-12-CF-TM-0

Figure 2-3.1. TS-1949A/URM-157 top panel operating controls and connectors.

Page 17, paragraph 2-5, chart. "Control" column.  
Line 4. After "300 Ω AUDIO LOAD" add "or  
AUDIO LOAD."

Line 5. After "CW KEY" add "or CW."

Page 18, paragraph 2-5b. Chart, "Connection"  
column, Line 1.

Change 618-2/3 to 618T-2/3 or 618T-2/2B/3/3B.  
At the end of the chart add:

Cable or cable adapter	Connection	Connection
Dc power cable W13	DC IN on test unit ANT. CPLR on test unit	Dc power supply J1 on 490T antenna coupler

Figure 2-5. Delete figure 2-5 and add new figure 2-5.

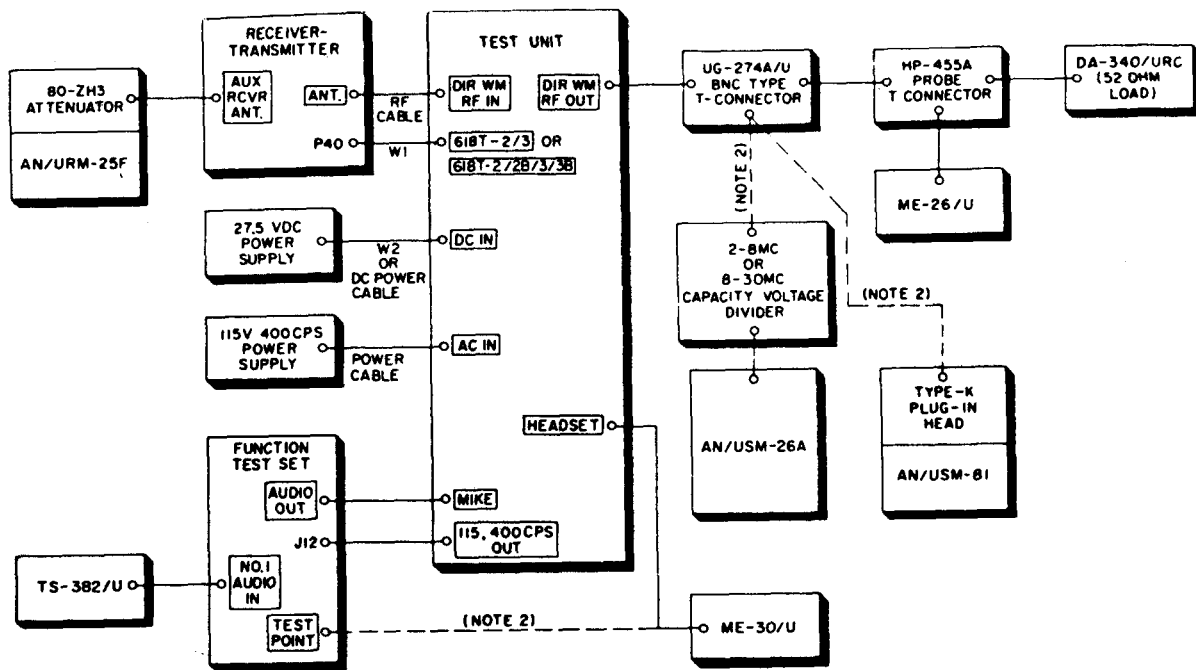

NOTES:  
 1.  INDICATES EQUIPMENT MARKINGS.  
 2. - - - DENOTES ALTERNATE CONNECTION.

EL6625-622-12-C2-TM-10

Figure 2-5. Typical bench test setup.

Page 27, Section II, chart. "PART OR COMPONENT" column.  
 Line 1. After "AN/URM-157" add "OR AN/URM-

157A."  
 Line 5. After "TS-1949/URM-157" add "OR TS-1949A/URM-157."

By Order of the Secretary of the Army:

W. C. WESTMORELAND,  
 General, United States Army,  
 Chief of Staff.

Official:

VERNE L. BOWERS,  
 Major General, United States Army,  
 The Adjutant General.

Distribution:

To be distributed in accordance with DA Form 12-36, Sec II (qty rqr Block Nr. 1028), Organizational maintenance requirements for avionics test equipment literature for AN/URM-157.



CHANGE }  
No. 1 }

HEADQUARTERS  
DEPARTMENT OF THE ARMY  
WASHINGTON, D.C., 3 March 1966

**Organizational Maintenance Manual Including Repair Parts and Special Tool lists**

**TEST HARNESS, RADIO SET AN/URM-157**

TM 11-6625-622-12, 10 December 1964, is changed as follows:

The title of this manual is changed as shown above.

Page 3, paragraph 1-2. Delete paragraph 1-2 and substitute:

**1-2. Index of Publications**

Refer to the latest issue of DA Pam 310-4 to determine whether there are new editions, changes, or additional publications pertaining to the equipment. DA Pam 310-4 is an index of current technical manuals, technical bulletins, supply manuals (types 7, 8, and 9), supply bulletins, lubrication orders, and modification work orders available through publications supply channels. The index lists the individual parts (-10, -20, -35P, etc.) and the latest changes to and revisions of each equipment publication.

Paragraph 1-3. Delete subparagraph *c* and substitute:

*c. Reporting of Equipment Manual Improvements.* The direct reporting by the individual user of errors, omissions, and recommendations for improving this manual is authorized and encouraged. DA Form 2028 (Recommended Changes to DA Publications) will be used for reporting these improvement recommendations. This form will

be completed using pencil, pen, or typewriter and forwarded direct to Commanding General, U.S. Army Electronics Command, ATTN: AMSEL-MR-(NMP)-MA, Fort Monmouth, N.J., 07703.

Page 29, paragraph A3-2g. Delete the last sentence.

Add paragraph A3-3 after paragraph A3-2.

**A3-3. Maintenance Float Requirements**

Supply Bulletin SB 11-244 is the authorizing document for maintenance float. It authorizes a maximum number of major components which are installed in Army Aircraft and states in part:

"A careful review will be made by the responsible maintenance officer to limit maximum percentage of maintenance float to only those items that exhibit high-failure rates. Items authorized for stockage as maintenance float will be included on the theater or installation authorized stockage list in accordance with AR 711-16, coded to indicate that stockage is for maintenance float. In the case of avionics maintenance float, the field maintenance officer is encouraged to locate the float at Army airfields in order to obtain maximum utilization."

Page 30, section II. Delete section II and substitute:

## SECTION II. OPERATOR'S FUNCTIONAL PARTS LIST

FEDERAL STOCK NUMBER	DESIGNATION BY MODEL	DESCRIPTION	UNIT OF ISSUE	EXP	QTY AUTH	ILLUSTRATION	
						FIGURE NO.	ITEM NO.
6625-766-4685		TEST HARNESS, RADIO SET AN/URM-157		NX			
		ITEMS COMPRISING AN OPERABLE EQUIPMENT					
ORD THRU AGC		TECHNICAL MANUAL TM 11-6625-622-12			2		
		<u>Note:</u> For technical manuals the quantity authorized indicated the number of copies packed with the equipment at the time of procurement. It represents the maximum quantity authorized. Where a number of these equipments are concentrated in a small area, the quantity on hand may be reduced to practical levels. Excess publications must be returned to publication supply centers through AG channels.					
5995-797-7299		CABLE ASSEMBLY, SPECIAL PURPOSE, ELECTRICAL, BRANCHED CX-8998/URM-157		NX	1		W2
5995-985-8167		CABLE ASSY, SPECIAL PURPOSE ELECTRICAL CX-11046/URM-157		NX	1		W12
6625-766-3676		CASE, TEST HARNESS CX-4604/URM-157			1		
5821-953-2209		CONTROL, RADIO SET C-3940/ARC-95: 13499, 522-2457-00 (MAINTENANCE FLOAT)		NX	1		
5935-258-7429		ADAPTER, CONN: 80058, UG201AU			1		
5995-985-8181		CABLE ASSEMBLY, SPECIAL PURPOSE, ELECTRICAL CX-9001/URM-157		NX	1		W4
5995-985-8178		CABLE ASSEMBLY, SPECIAL PURPOSE, ELECTRICAL CX-9002/URM-157		NX	1		W5
5995-985-8176		CABLE ASSEMBLY, SPECIAL PURPOSE, ELECTRICAL CX-9004/URM-157		NX	1		W7
5995-985-8177		CABLE ASSEMBLY, SPECIAL PURPOSE, ELECTRICAL CX-9003/URM-157		NX	1		W6
5995-985-8182		CABLE ASSEMBLY, SPECIAL PURPOSE, ELECTRICAL CX-9005/URM-157		NX	1		W8
5995-985-8179		CABLE ASSEMBLY, SPECIAL PURPOSE, ELECTRICAL CX-8999/URM-157		NX	1		
5995-985-8180		CABLE ASSEMBLY, SPECIAL PURPOSE ELECTRICAL CX-9000/URM-157			1		W3
5995-985-8183		CABLE ASSEMBLY, SPECIAL PURPOSE, ELECTRICAL CX-9006/URM-157		NX	1		W9
5995-985-8168		CABLE ASSEMBLY, SPECIAL PURPOSE, ELECTRICAL CX-11044/URM-157		NX	1		W10

SECTION II MAINTENANCE ALLOCATION CHART  
FOR

TEST HARNESS, RADIO SETS AN/URM-157 AND AN/URM-157A

(1) GROUP NUMBER	(2) COMPONENT/ASSEMBLY	(3) MAINTENANCE FUNCTION	(4) MAINTENANCE CATEGORY					(5) TOOLS AND EQUIPMENT
			C	O	F	H	D	
00	TEST HARNESS, RADIO SET AN/URM-157 AND AN/URM-157A	Inspect Test1 Repair		0.1 0.3			1.0	4 1,2,3,5,6
01	CABLE ASSEMBLY, POWER ELECTRICAL CX-8998/URM-157	Inspect Repair		0.1			0.5	1,2,3,5
02	CABLE ASSEMBLY, SPECIAL PURPOSE ELECTRICAL CX-9000/URM-157	Inspect Repair		0.1			0.6	1,2,3,5
03	CABLE ASSEMBLY, SPECIAL PURPOSE ELECTRICAL CX-8997/URM-157	Inspect Repair		0.1			0.5	1,2,3,5
04	CABLE ASSEMBLY, SPECIAL PURPOSE ELECTRICAL CX8999/URM-157	Inspect Repair		0.1			0.5	1,2,3,5
05	CABLE ASSEMBLY, SPECIAL PURPOSE ELECTRICAL CX-9001/URM-157	Inspect Repair		0.1			0.5	1,2,3,5
06	CABLE ASSEMBLY, SPECIAL PURPOSE ELECTRICAL CX-9003/URM-157	Inspect Repair		0.1			0.5	1,2,3,5
07	CABLE ASSEMBLY, SPECIAL PURPOSE ELECTRICAL CX-9004/URM-157	Inspect Repair		0.1			0.5	1,2,3,5
08	CABLE ASSEMBLY, SPECIAL PURPOSE ELECTRICAL CX-9002/URM-157	Inspect Repair		0.1			0.5	1,2,3,5
09	CABLE ASSEMBLY, SPECIAL PURPOSE ELECTRICAL CX-9005/URM-157	Inspect Repair		0.1			0.5	1,2,3,5
10	CABLE ASSEMBLY, SPECIAL PURPOSE ELECTRICAL CX-9006/URM-157	Inspect Repair		0.1			0.5	1,2,3,5
11	CABLE ASSEMBLY, RADIO FREQUENCY CG-2727/U	Inspect Repair		0.1			1.0	1,2,3,5
12	CABLE ASSEMBLY, SPECIAL PURPOSE ELECTRICAL CX-11046/URM-157	Inspect Repair		0.1			0.5	1,2,3,5
13	CABLE ASSEMBLY, SPECIAL PURPOSE ELECTRICAL CX-10594/URM-157	Inspect Repair		0.1			0.5	1,2,3,5
14	CABLE ASSEMBLY, SPECIAL PURPOSE ELECTRICAL CX-11045/URM-157	Inspect Repair		0.1			0.5	1-3,5
15	CABLE ASSEMBLY, SPECIAL PURPOSE ELECTRICAL CX-11044/URM-157	Inspect Repair		0.1			0.5	1-3,5
16	TEST HARNESS SUBASSEMBLY TS-1949-URM-157 TS-1949A/URM-157	Inspect Test1 Repair		0.2 0.2			1.0	4 1-3,5
17	CONTROL, RADIO SET C-3940/ARC-94 (SEE TM 11-5821-248-( ) SERIES FOR MAINTENANCE FUNCTIONS)							
18	CABLE ASSEMBLY, SPECIAL PURPOSE ELECTRICAL CX-12612/URM-157A	Inspect Repair		0.1			0.5	1-3,5

(1) Operational test.

TABLE 1. TOOL AND TEST EQUIPMENT REQUIREMENTS  
FOR

TEST HARNESS, RADIO SETS AN/URM-157 AND AN/URM-157A

TOOL OR TEST EQUIPMENT REF CODE	MAINTENANCE CATEGORY	NOMENCLATURE	NATIONAL/NATO STOCK NUMBER	TOOL NUMBER
1	H	MULTIMETER AN/USM-223	6625-00-999-7465	
2	H	MULTIMETER ME-26/U	6625-00-542-6407	
3	H	TOOL KIT, ELECTRONIC EQUIPMENT TK-100/G	5810-00-605-0079	
4	O	TOOL KIT, ELECTRONIC EQUIPMENT TK-101/G	5180-00-064-5178	
5	H	TOOL KIT, ELECTRONIC EQUIPMENT TK-105/G	5180-00-610-8177	
6	H	TEST SET, RADIO FREQUENCY AN/URM-120	6625-00-813-8430	

By Order of the Secretary of the Army:

**BERNARD W. ROGERS**  
*General, United States Army*  
*Chief of Staff*

Official:

**PAUL T. SMITH**  
*Major General, United States Army*  
*The Adjutant General*

**DISTRIBUTION**

To be distributed in accordance with DA Form 12-36A, Organizational Maintenance requirements for AN/URM-157



DEPARTMENT OF THE ARMY TECHNICAL MANUAL

OPERATOR AND ORGANIZATIONAL MAINTENANCE MANUAL  
 TEST HARNESS, RADIO SET AN/URM-157

Headquarters, Department of the Army, Washington, D. C. 20315

10 December 1964

	Paragraph	Page
CHAPTER 1. INTRODUCTION		
Section I. General		
Scope of manual . . . . .	1-1	3
Index of publications . . . . .	1-2	3
Forms and records . . . . .	1-3	3
II. Description and data		
Purpose and use . . . . .	1-4	3
Technical characteristics . . . . .	1-5	3
Components of Test Harness, Radio Set AN/URM-157 . . . . .	1-6	4
Common names . . . . .	1-7	5
Description of Test Harness Subassembly TS-1949/URM-157 . . . . .	1-8	5
Description of minor components . . . . .	1-9	5
CHAPTER 2. OPERATION		
Section I. Service upon receipt of equipment . . . . .		
Unpacking . . . . .	2-1	9
Checking unpacked equipment . . . . .	2-2	9
II. Operating instructions		
Operating controls, indicators, and connectors . . . . .	2-3	11
Bench test procedures . . . . .	2-4	17
Preliminary starting procedures for test unit . . . . .	2-5	17
Stopping procedures for test unit . . . . .	2-6	18
CHAPTER 3. MAINTENANCE INSTRUCTIONS		
Scope of maintenance . . . . .	3-1	19
Tools and materials required for maintenance . . . . .	3-2	19
Preventive maintenance . . . . .	3-3	19
Daily preventive maintenance checks and services . . . . .	3-4	19
Daily preventive maintenance checks and services chart . . . . .	3-5	20
Cleaning . . . . .	3-6	20
Monthly preventive maintenance checks and services . . . . .	3-7	20
Monthly preventive maintenance checks and services chart . . . . .	3-8	20
Preservation . . . . .	3-9	21
Quarterly preventive maintenance checks and services . . . . .	3-10	21
Quarterly preventive maintenance checks and services chart . . . . .	3-11	21
CHAPTER 4. SHIPMENT, LIMITED STORAGE, AND DEMOLITION TO PREVENT ENEMY USE		
Section I. Shipment and limited storage		
Disassembly of equipment . . . . .	4-1	22
Repackaging for shipment and limited storage . . . . .	4-2	22
II. Demolition of materiel to prevent enemy use . . . . .		
Authority for demolition . . . . .	4-3	22
Methods of destruction . . . . .	4-4	22
APPENDIX I. REFERENCES . . . . .		24
II. MAINTENANCE ALLOCATION . . . . .		25
III. BASIC ISSUE ITEMS LIST . . . . .		29

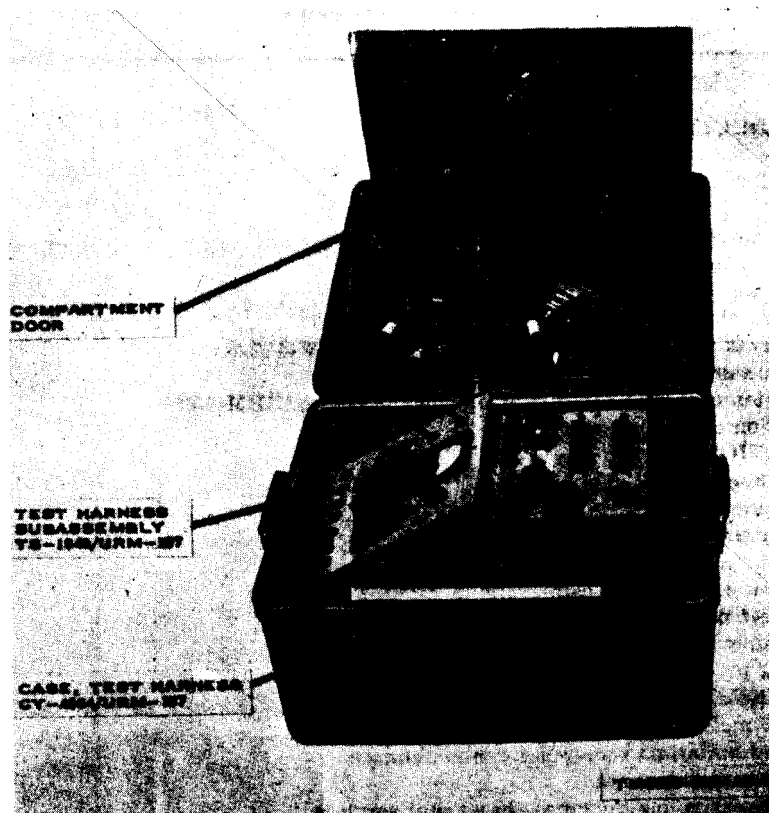

*Figure 1-1. Test Harness, Radio Set AN/URM-157.*



## CHAPTER 1

### INTRODUCTION

---

#### Section I. GENERAL

##### 1-1. Scope of Manual

This manual describes Test Harness, Radio Set AN/URM-157 (fig. 1-1) (Collins type 678P-2) and covers its operation and operator and organizational maintenance. The manual includes operation under usual and unusual conditions, cleaning and inspection of the equipment, and replacement of parts available to organizational maintenance personnel.

##### 1-2. Index of Publications

Refer to the latest issue of DA Pamphlet 310-4 to determine whether there are new editions, changes, or additional publications pertaining to the equipment. Department of the Army Pamphlet No. 310-4 is an index of current technical manuals, technical bulletins, supply manuals (types 4, 6, 7, 8, and 9), supply catalogs (type CL), supply bulletins, lubrication orders, and modification work orders that are available through publications supply channels. The index lists the individual parts (-10, -20, -35P, etc) and the latest changes to and revisions of each equipment publication.

##### 1-3. Forms and Records

*a. Report of Unsatisfactory Equipment.* Use equipment forms and records in accordance with instructions in TM 38-750.

*b. Report of Damaged or Improper Shipment.* Fill out and forward DD Form 6 (Report of Damaged or Improper Shipment) as prescribed in AR 700-58 (Army), NAVSANDA Publication 378 (Navy), and AFR 71-4 (Air Force).

*c. Reporting Equipment Manual Improvement.* The direct reporting, by the individual user, of errors, omissions, and recommendations for improving this equipment manual is authorized and encouraged. DA Form 2028 will be used for reporting these improvements. This form may be completed by the use of pencil, pen, or typewriter. DA Form 2028 will be completed in triplicate and forwarded by the individual using the manual. The original and one copy will be forwarded direct to: Commanding General, U.S. Army Electronics Command, ATTN: AMSEL-MR-MA, Fort Monmouth, New Jersey 07703. One information copy will be furnished to the individual's immediate supervisor (officer, noncommissioned officer, supervisor, etc).

#### Section II. DESCRIPTION AND DATA

##### 1-4. Purpose and Use

*a. Purpose.* Test Harness, Radio Set AN/URM-157 (fig. 1-1) (Collins type Test Harness 678P-1 and transit case, which together are designated a 678P-2) provides the means of connecting and controlling Receiver-Transmitter, Radio RT-698/ARC-102 (Collins type 618T-3) to facilitate testing, troubleshooting, and aligning the receiver-transmitter. The AN/URM-157 controls power, radiofrequency (rf), and audio signals and facilitates interconnection of system units. An rf wattmeter for measuring

transmitter power output is incorporated in the AN/URM-157.

*b. Use.* The AN/URM-157 is used by the repairman to perform bench troubleshooting of the RT-698/ARC-102 (Collins type 618T-3).

##### 1-5. Technical Characteristics

###### *a. General.*

Ambient temperature range:

Operating	0° C to +50° C.
Nonoperating	0° C to +50° C.

Ambient humidity range Prevailing laboratory or repair station environmental conditions.

Weight 45 pounds.  
*b. Test Unit.*  
 Directional wattmeter:  
 Meter scales 0 to 200 watts.  
 0 to 2.0 kilowatts.  
 Accuracy ±10% at full scale.  
 Frequency range 2 to 30 mc.

Altitude limits:

Operating 10,000 feet.  
 Nonoperating No upper limit.

1-6. Components of Test Harness, Radio Set AN/URM-157

Note: This listing is based on the original shipment by the contractor on Order No. FR-11-022-C-4-26699(E). For the current official listing of components, refer to the basic issue items list (appx III).

Quantity	Item	Dimensions (in.)			Unit weight (lb)	Figure
		Height	Depth	Width		
1	Test Harness Subassembly TS-1949/URM-157	9 7/16	16	8 1/2	13	1-2
1	Case, Test Harness CY-4064/URM-157	18 7/8	17 1/16	21 1/2	11.0	1-1
2	Adapter UG-201A/U				0.06	1-4
1	Cable Assembly, Special Purpose, Electrical CX-8997/URM-157 (62" lg)				4.5	1-3
1	Cable Assembly, Power, Electrical, Branched CX-8998/URM-157 (5' 0" lg)				2.125	1-3
1	Cable Assembly, Special Purpose, Electrical CX-8999/URM-157 (5' 0" lg)				0.45	1-3
1	Cable Assembly, Special Purpose, Electrical CX-9000/URM-157 (5' 2" lg)				2.5	1-3
1	Cable Assembly, Special Purpose, Electrical CX-9001/URM-157 (1' 0" lg)				0.7	1-3
1	Cable Assembly, Special Purpose, Electrical CX-9002/URM-157 (1' 0" lg)				0.5	1-3
1	Cable Assembly, Special Purpose, Electrical CX-9003/URM-157 (5' 0" lg)				1.25	1-3
1	Cable Assembly, Special Purpose, Electrical CX-9004/URM-157 (5' 0" lg)				1.15	1-4
1	Cable Assembly, Special Purpose, Electrical CX-9005/URM-157 (5' 0" lg)				0.75	1-4
1	Cable Assembly, Special Purpose, Electrical CX-9006/URM-157 (5' 0" lg)				0.8	1-4
1	Cable Assembly, Radio Frequency CG-2727/U (5' 0" lg)				0.2	1-4
1	Cable Assembly, Special Purpose, Electrical CV-11044/URM-157				1.25	1-4
1	Cable Assembly, Special Purpose, Electrical CX-11046/URM-157				1.25	1-4
1	Control, Radio Set C-3940/ARC-94	2 7/8	3 3/4	5 3/4	2.0	1-2
1	Cable Assembly, Special Purpose, Electrical CX-11045/URM-157				1.4	1-4
1 set	Running spares: 5 spare fuse cartridges, 115 volts, 5 amp 3 spare fuse cartridges, 28 volts, 10 amp				0.03	1-4 1-4

1-7. Common Names

Nomenclature	common name
Test Harness, Radio Set AN/URM-157	Test harness
Case Test Harness CY-4064/URM-157	Transit case
Test Harness Subassembly TS-1949/URM-157	Test unit
Adapter UG-201A/U	Adapter
Cable Assembly, Special Purpose, Electrical CX-8997/URM-157	Cable W1
Cable Assembly, Power, Electrical, Branched CX-8998/URM-157	Cable W2
Cable Assembly, Special Purpose, Electrical CX-8999/URM-157	Power cable
Cable Assembly, Special Purpose, Electrical CX-9000/URM-157	Cable W3
Cable Assembly, Special Purpose, Electrical CX-9001/URM-157	Cable W4
Cable Assembly, Special Purpose, Electrical CX-9002/URM-157	Cable W5
Cable Assembly, Special Purpose, Electrical CX-9003/URM-157	Cable W6
Cable Assembly, Special Purpose, Electrical CX-9004/URM-157	Cable W7
Cable Assembly, Special Purpose, Electrical CX-9005/URM-157	Cable W8
Cable Assembly, Special Purpose, Electrical CX-9006/URM-157	Cable W9
Cable Assembly, Radio Frequency CG-2727/U (5 ft, 0.1 in.)	Rf cable
Cable Assembly, Special Purpose, Electrical CX-11045/URM-157	Cable W10
Cable Assembly, Special Purpose, Electrical CX-11044/URM-157	Cable W11
Control, Radio Set C-3940/ARC-94	Control unit
Cable Assembly, Special Purpose, Electrical CX-11046/URM-157	Cable W12

1-8. Description of Test Harness Subassembly TS-1949/URM-157

The test unit (fig. 1-2) is intended for use while mounted in its fiberglass carrying case. Most of the operating controls and connectors are located on a sloping front surface panel and top panel for convenient operation. A dummy antenna input, an alternating current (ac) convenience outlet, and a ground jack are on the vertical rear panel. The test unit includes controls and connectors for use in testing the Collins type 618T-1 and 618T-2 transceivers. These equipments are not used by the U.S. Army and therefore test unit functions applicable to these equipments are not covered in this manual. The test unit does not consume

power internally. The power requirements will be determined by the receiver-transmitter under test. An internal rf load is provided for use as a dummy antenna. Included as part of the test unit is Control, Radio Set C-3940 ARC-94 (Collins type 714E-3), which is mounted in the center of the front panel. The control unit indicates and controls operating frequency and controls the mode of operation and the sensitivity of the receiver-transmitter.

1-9. Description of Minor Components

a. *Transit Case* (fig. 1-1). The transit case is of molded, reinforced, fiberglass construction with aluminum framework and hardware. It provides a dustproof, portable enclosure for the equipment, with an air relief valve (not shown) for airborne transportation. The transit case is composed of two parts. One half houses the test unit and a small bracket containing the technical manuals. The other half contains a closed compartment. When the door to this half is opened, access is provided to a space containing the test cables and adapters furnished with the equipment. The two halves are fastened together by four twistlock clamps. A dust cover, on the side of the lower half of the transit case, when removed, provides access to connectors on the rear panel of the test unit.

b. *Cables* (fig. 1-3 and 1-4). Fourteen cables are provided as components of the test harness. Each cable is identified by a metal band which contains the short nomenclature. The following is a description of the main cables and adapters:

- (1) *Cable W1*. Cable W1, is a 60-conductor, rubber-covered cable, 5 feet long, with a 60-pin male connector on one end and a 60-pin female connector on the other end.
- (2) *Cable W2*. Cable W2 is a four-conductor, rubber-covered cable, 5 feet long, with a four-pin female connector on one end and two alligator clips on the other end.
- (3) *Cable W3*. Cable W3 is a 23-conductor, rubber-covered cable, 5 feet, 2 inches long, with a 23-pin male connector on one end and a 23-pin female connector on the other end.

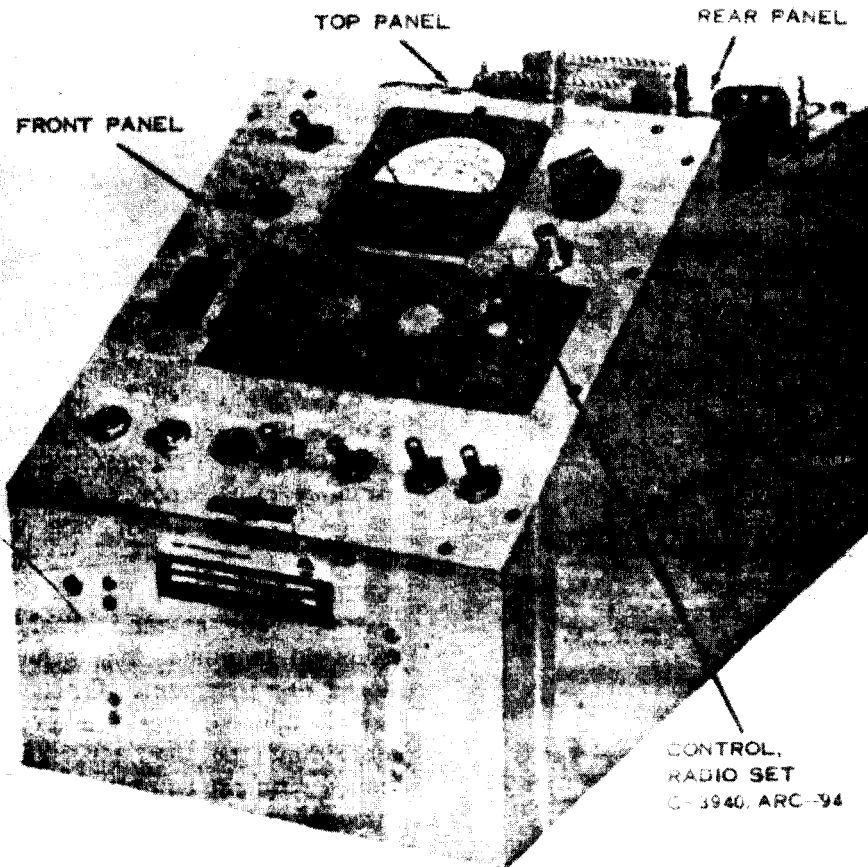

TM 6625-622-12-2

Figure 1-2. Test unit and control unit.

- (4) *Cable W4.* Cable W4 is a 35-conductor, rubber-covered cable, 1 foot long, with a 41-pin male connector on one end and a 35-pin female connector on the other end.
- (5) *Cable W5.* Cable W5 is a 39-conductor, rubber-covered cable, 1 foot long, with a 41-pin male connector on one end and a 39-pin female connector on the other end.
- (6) *Cable W6.* Cable W6 is a 33-conductor, rubber-covered cable, 5 feet long, with a 41-pin male connector on one end and a 37-pin female connector on the other end.
- (7) *Cable W7.* Cable W7 is a 26-conductor, rubber-covered cable, 5 feet long, with a 41-pin male connector on one end and a 26-pin female connector on the other end.
- (8) *Cable W8.* Cable W8 is a 13-conductor, rubber-covered cable, 5 feet long, with a 41-pin male connector on one end and a 16-pin female connector on the other end.
- (9) *Cable W9.* Cable W9 is a 13-conductor, rubber-covered cable, 5 feet long, with a 41-pin male connector on one end and a 17-pin female connector on the other end.
- (10) *Cable W10.* Cable W10 is a 13-conductor, rubber-covered cable, 5 feet long, with a 41-pin male connector on one end and an 18-pin female connector on the other end.
- (11) *(Cable W11.* Cable W11 is a 28-conduc-

- tor, rubber-covered cable, 4 feet long, with a 41-pin male connector on one end and a 41-pin female connector on the other end.
- (12) *Cable W12* Cable W12 is a 9-conductor rubber-covered cable, 4 feet long, with a 9-pin cannon connector at one end and a 23-pin male connector on the other end.
- (13) *Power cable.* The power cable is a four-conductor, rubber-covered cable, 5 feet long, with a four-pin female connector on one end and four bare wires on the other end.

- (14) *Rf cable.* The rf cable is a coaxial, vinyl-covered cable, 5 feet long, with a male BNC connector on each end.
- (15) *Adapter.* The two rf cable adapters have a male-type N-connector on one end and a female-type BNC connector on the other end. The two adapters are stored in a cloth bag supplied with the equipment.

c. *Running Spares* (fig. 1-4). Five 115-volt, 5-ampere, and three 28-volt, 10-ampere fuses are included as running spares.

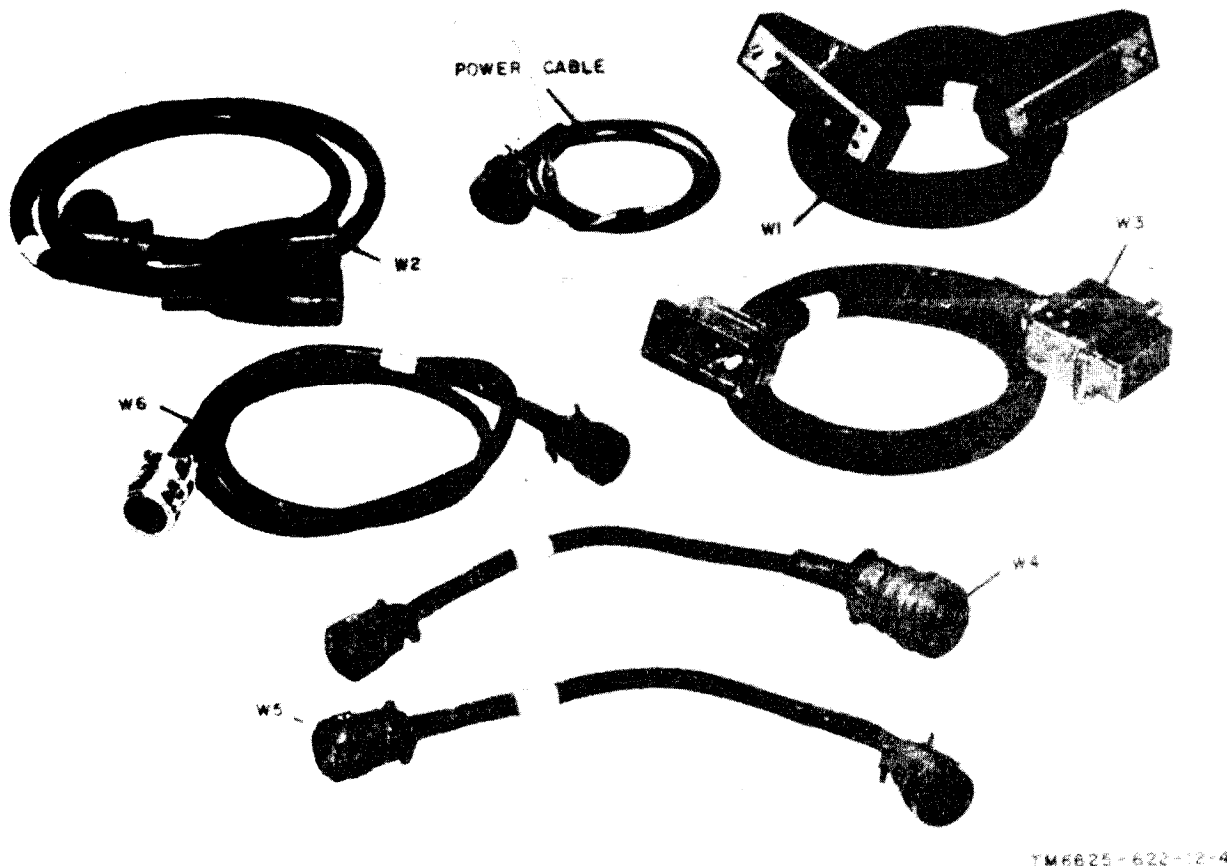

Figure 1-3. Cables.

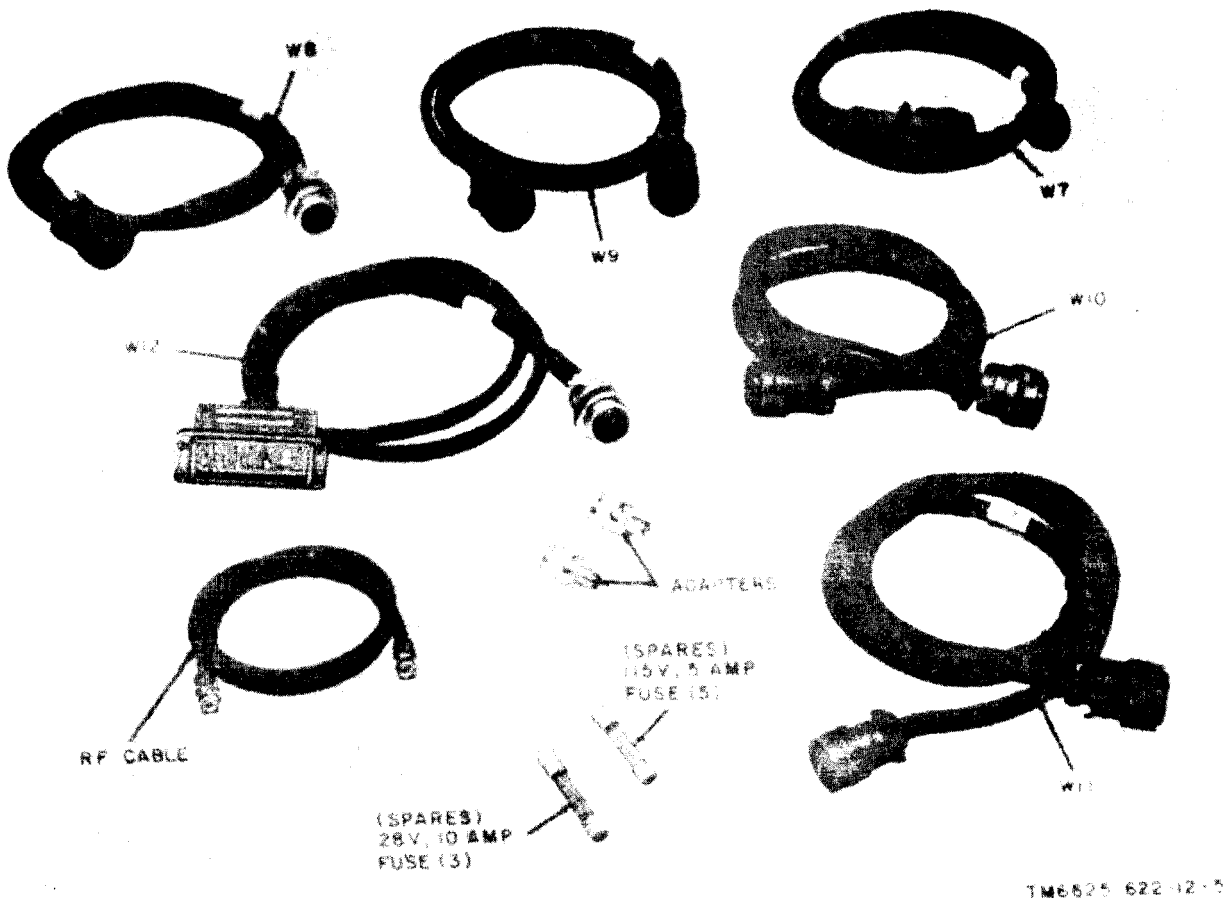

Figure 1-4. Cables, adapters, and spare fuses.

## CHAPTER 2

### OPERATION

---

#### Section 1. SERVICE UPON RECEIPT OF EQUIPMENT

##### 2-1. Unpacking

*a. Packaging Data.* All components of the test harness are in the transit case. When packed for shipment, the air vent on the transit case is opened, and the test harness is on four polystyrene corner blocks that are in the four bottom corners of a tri-wall fiberboard box. Four more corner blocks are on the top four corners of the test harness. The box is closed and taped shut. The box is 26 by 23 by 22 inches, the corner blocks are 6 by 6 by 6 inches with cutouts of 4 by 4 by 4 inches, the total weight is 45 pounds, and the volume is 7.6 cubic feet. A typical shipping box and its contents are shown in figure 2-1.

*b. Removing Contents.*

- (1) Use a knife to cut the tape on the box. Open the four flaps.
- (2) Remove the four corner blocks from the top of the box. Remove the test harness from the box.
- (3) Disengage the four twist-lock clamps and open the transit case.
- (4) Remove the technical manuals from their compartment.
- (5) Unlock the access door by turning the two quarter-turn fasteners. Lift the door open.

- (6) Remove the cables and cable adapters from their storage space.

##### 2-2. Checking Unpacked Equipment

*a.* Inspect the equipment for damage incurred during shipment. If the equipment has been damaged, refer to paragraph 1-3b.

*b.* Check the equipment against the packing list. When no packing list accompanies the equipment, check the equipment against the list of equipment supplied (para 1-6) and report any overages or shortages on DD Form 6 (para 1-3b).

*Note:* Shortages of minor assemblies or subassemblies such as lamps or fuses that do not affect the proper functioning of the equipment should not prevent use of the equipment.

*c.* If the equipment has been used or reconditioned, see whether it has been changed by a modification work order (MWO). If the equipment has been modified, the MWO number will appear on the front panel near the nomenclature plate. Check to see whether the MWO number and appropriate notations concerning the modification have been entered in this manual.

*Note:* Current MWO's applicable to the equipment are listed in DA Pamphlet 310-4.

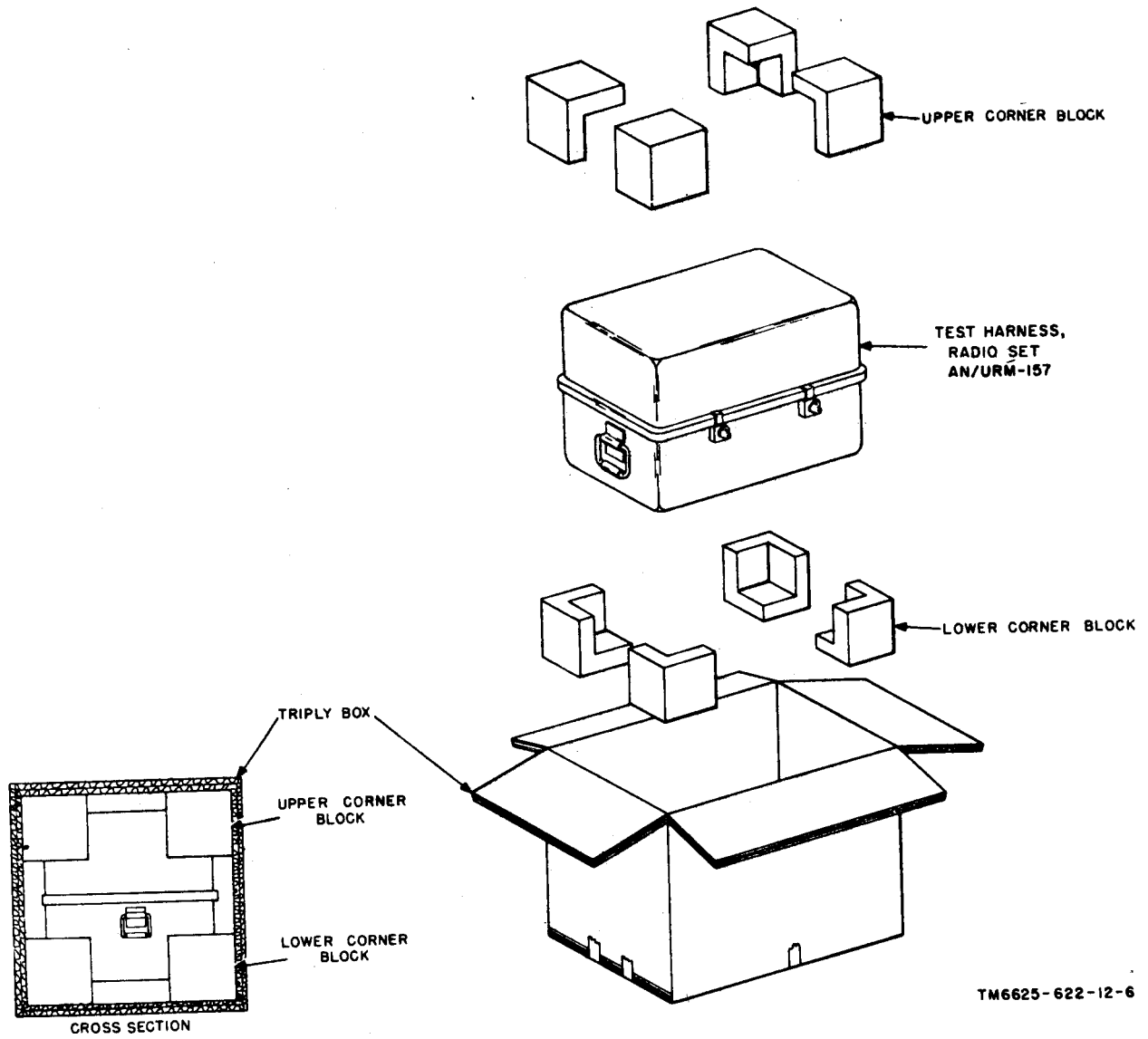

TM6625-622-12-6

Figure 2-1. Typical packaging.



Section II. OPERATING INSTRUCTIONS

2-3. Operating Controls, Indicators, and Connectors

The charts in *a* through *b* below list the test

-unit controls, indicators, and connectors and indicate their functions.

*a. Front Panel* (fig. 2-2).

Control, indicator or connector  
 618T-2-OFF-618T-3 switch (3-position toggle)  
  
**Caution: Be sure switch is in 618T-3 position or receiver-transmitter will be damaged.**

Function  
 Connects voltages for the type of transceiver under test to the proper test unit jack.

Switch position	Action
618T-2	Not used.
OFF	Not used.
618T-3	Connects voltages for the receiver-transmitter to the multiple pin connector 618T-2/3 on top panel.

RF OUTPUT meter  
 WATTS REFLECTED-FORWARD switch (4-position rotary)

Indicates the transmitter rf output in watts, forward or reflected.  
 Connects the appropriate power range and direction of rf to the RF OUTPUT meter.

Switch position	Action
<b>REFLECTED:</b>	
200	RF OUTPUT meter will read 200 watts of reflected rf at full scale.
2000	RF OUTPUT meter will read 2 kilowatts of reflected rf at full scale.
<b>FORWARD:</b>	
200	RF OUTPUT meter will read 200 watts of forward rf at full scale.
2000	RF OUTPUT meter will read 2 kilowatts of forward rf at full scale.

TUNE POWER switch (push-button)  
*Note: To avoid damage to receiver-transmitter, do not depress for more than 15 seconds.*

Grounds the receiver-transmitter tune powerline to check the function of the tune circuitry within the receiver-transmitter. Is not used with antenna couplers.

KEY switch (3-position toggle)

Provides remote keying of the transmitter section of the receiver-transmitter in the USB, LSB, and AM positions of mode selector switch control unit.

Switch position	Action
On (up)	Provides continuous keying of the transmitter by grounding the usb, lsb, and AM keying circuits.
Off (center)	Removes the ground from the transmitter keying circuit.
Momentary on (down)	Spring-loaded position which provides keying of the transmitter by grounding the keying circuit when the switch is held down.



b. Control Unit Front Panel (fig. 2-2).

Control, indicator or connector	Function														
<b>Mode selector switch (6-position rotary)</b>	<p>Selects the mode of operation of the receiver-transmitter.</p> <table border="0"> <tr> <td style="text-align: right;"><i>Switch position</i></td> <td style="text-align: left;"><i>Action</i></td> </tr> <tr> <td>OFF</td> <td>No operational test may be performed on the receiver-transmitter.</td> </tr> <tr> <td>USB</td> <td>Permits operation and testing the receiver-transmitter in the upper sideband mode of operation.</td> </tr> <tr> <td>LSB</td> <td>Permits operation and testing the receiver-transmitter in the lower sideband mode of operation.</td> </tr> <tr> <td>AM</td> <td>Permits operation and testing the receiver-transmitter in the amplitude-modulated mode of operation.</td> </tr> <tr> <td>DATA</td> <td>Permits use of auxiliary data equipment. Used only in systems which include data equipment.</td> </tr> <tr> <td>CW</td> <td>Permits operation and testing the receiver-transmitter in the continuous-wave mode of operation.</td> </tr> </table>	<i>Switch position</i>	<i>Action</i>	OFF	No operational test may be performed on the receiver-transmitter.	USB	Permits operation and testing the receiver-transmitter in the upper sideband mode of operation.	LSB	Permits operation and testing the receiver-transmitter in the lower sideband mode of operation.	AM	Permits operation and testing the receiver-transmitter in the amplitude-modulated mode of operation.	DATA	Permits use of auxiliary data equipment. Used only in systems which include data equipment.	CW	Permits operation and testing the receiver-transmitter in the continuous-wave mode of operation.
<i>Switch position</i>	<i>Action</i>														
OFF	No operational test may be performed on the receiver-transmitter.														
USB	Permits operation and testing the receiver-transmitter in the upper sideband mode of operation.														
LSB	Permits operation and testing the receiver-transmitter in the lower sideband mode of operation.														
AM	Permits operation and testing the receiver-transmitter in the amplitude-modulated mode of operation.														
DATA	Permits use of auxiliary data equipment. Used only in systems which include data equipment.														
CW	Permits operation and testing the receiver-transmitter in the continuous-wave mode of operation.														
1-megacycle control (28-position rotary switch)	Selects portion of the receiver-transmitter operating frequency in 1-megacycle steps (first two digits, left to right).														
0.1-megacycle control (10-position rotary switch)	Selects portion of the receiver-transmitter operating frequency in 0.1-megacycle steps (third digit, left to right).														
0.01-megacycle control (10-position rotary switch)	Selects portion of the receiver-transmitter operating frequency in 0.01-megacycle steps (fourth digit, left to right).														
0.001-megacycle control (10-position rotary switch)	Selects portion of the receiver-transmitter operating frequency in 0.001-megacycle steps (fifth digit, left to right).														
Frequency indicator (numerical display)	Indicates frequency in megacycles.														
RF SENS control	Controls rf sensitivity of the receiver-transmitter.														

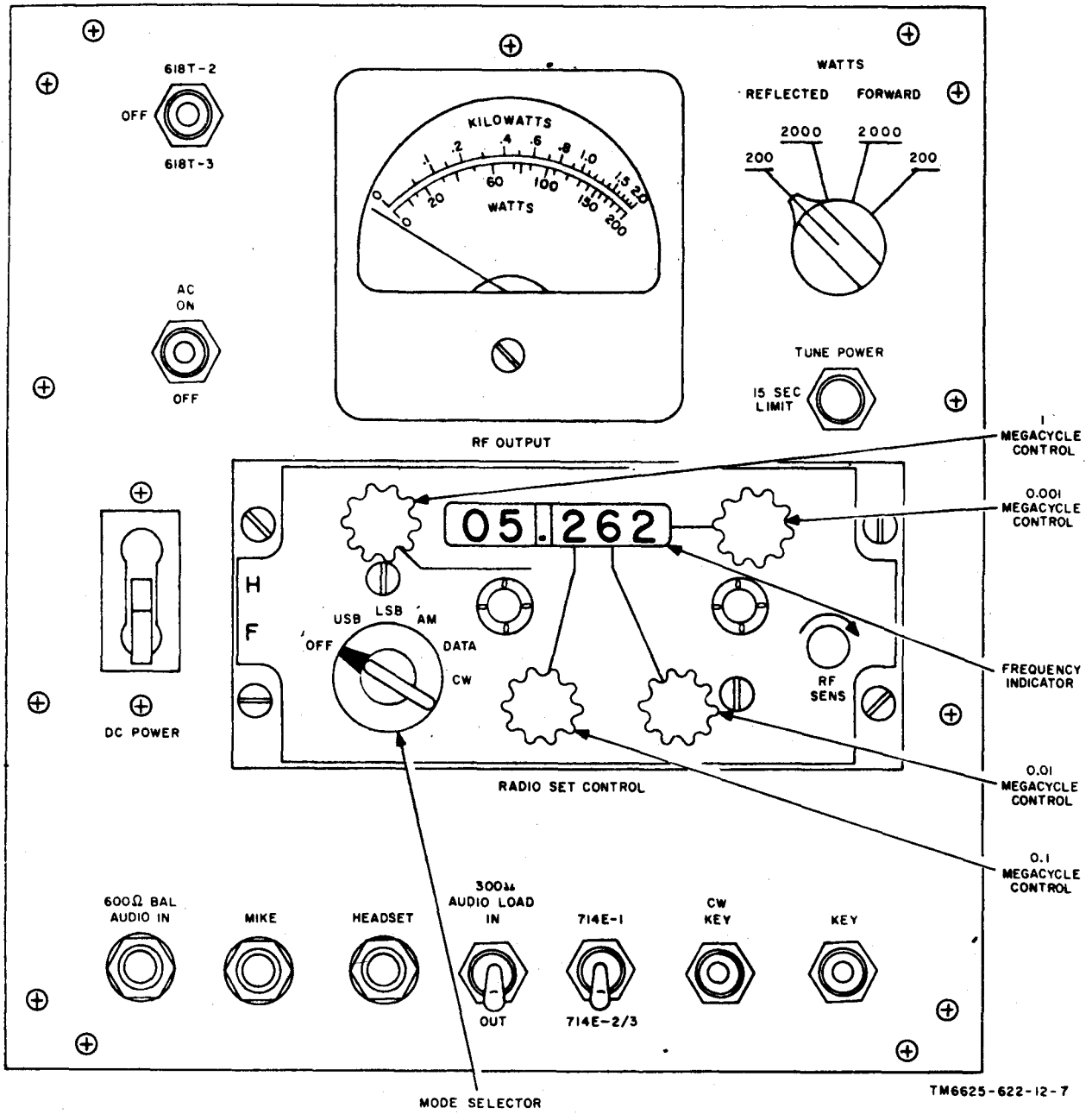

Figure 2-2. Test unit front panel operating controls, indicators, and connectors.

c. Top Panel (fig. 2-3).

Control or connector	Function						
618T-3/4 connector (60-pin)	Provides electrical connections to the test unit from the receiver-transmitter under test.						
618T-1 connector (60-pin)	Not used.						
DIR WM RF IN coaxial connector	Provides connection from the receiver-transmitter rf output to the test unit wattmeter.						
DC IN connector (4-pin)	Provides electrical connection to the test unit from 27.5-volt dc power supply.						
AC IN connector (4-pin)	Provides electrical connection to test unit from 1 15-volt, 3 phase, 400-cps ac power supply.						
ANT. CPLR connector (40-pin)	Provides electrical connection from various antenna couplers to the receiver-transmitter through the test unit.						
DIR WM RF OUT BNC connector	Provides electrical connection from the test unit rf wattmeter output to 50Ω RF LOAD connector on the top panel, or Dummy Load DA - 340/ARC-102.						
50Ω RF LOAD BNC connector	Provides electrical connection from the rf output of the receiver transmitter, through the test unit directional wattmeter, to the 50-ohm resistive load.						
KEY INTLTK switch (2-position toggle)	<p>Selects operation with or without antenna couplers.</p> <table border="0"> <tr> <td style="text-align: center;"><i>Switch position</i></td> <td style="text-align: center;"><i>Action</i></td> </tr> <tr> <td>BY PASS</td> <td>Permits operation without antenna couplers.</td> </tr> <tr> <td>NORMAL</td> <td>Permits operation with antenna couplers.</td> </tr> </table>	<i>Switch position</i>	<i>Action</i>	BY PASS	Permits operation without antenna couplers.	NORMAL	Permits operation with antenna couplers.
<i>Switch position</i>	<i>Action</i>						
BY PASS	Permits operation without antenna couplers.						
NORMAL	Permits operation with antenna couplers.						
5A φ1 FUSE, 5A φ2, FUSE, and 5A φ3 FUSE	Powerline fuses for 115 volts input, phases 1, 2, and 3.						
10 A 28V DC FUSE	Powerline fuse for 28-volt dc input.						
516 H-1 connector (23-pin)	Not used.						
GRD binding post connector	Provides electrical connection to circuit ground.						
Ground pins (2)	Provide electrical connections to circuit ground.						

d. Rear Panel (fig. 2-4).

Connector	Function
115 V, 400 CPS OUT outlet	Provides 115-volt, 400-cps ac convenience output for use with Test Set, Radio TS-1956/URC which is part of Maintenance Kit, Electronic Equipment MK-722/URC.
DUMMY ANTENNA INPUT jack (Banana plug)	Provides electrical connection from antenna coupler to resistive-capacitive dummy load. Primarily used with 180L series antenna couplers.
Ground (telephone jack)	Provides electrical connection to circuit ground.

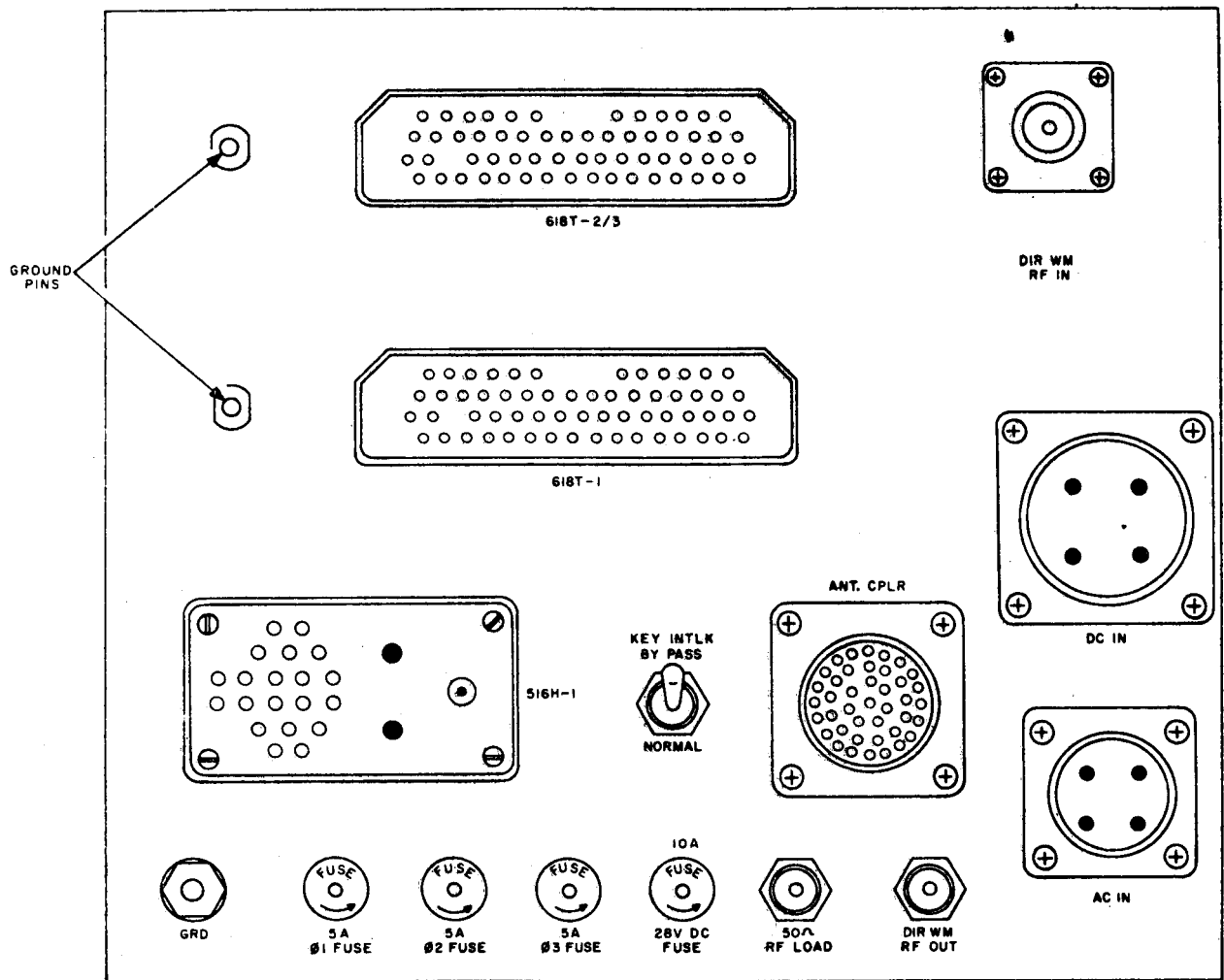

TM6625-622-12-8

Figure 2-3. Test unit top panel operating controls and connectors.

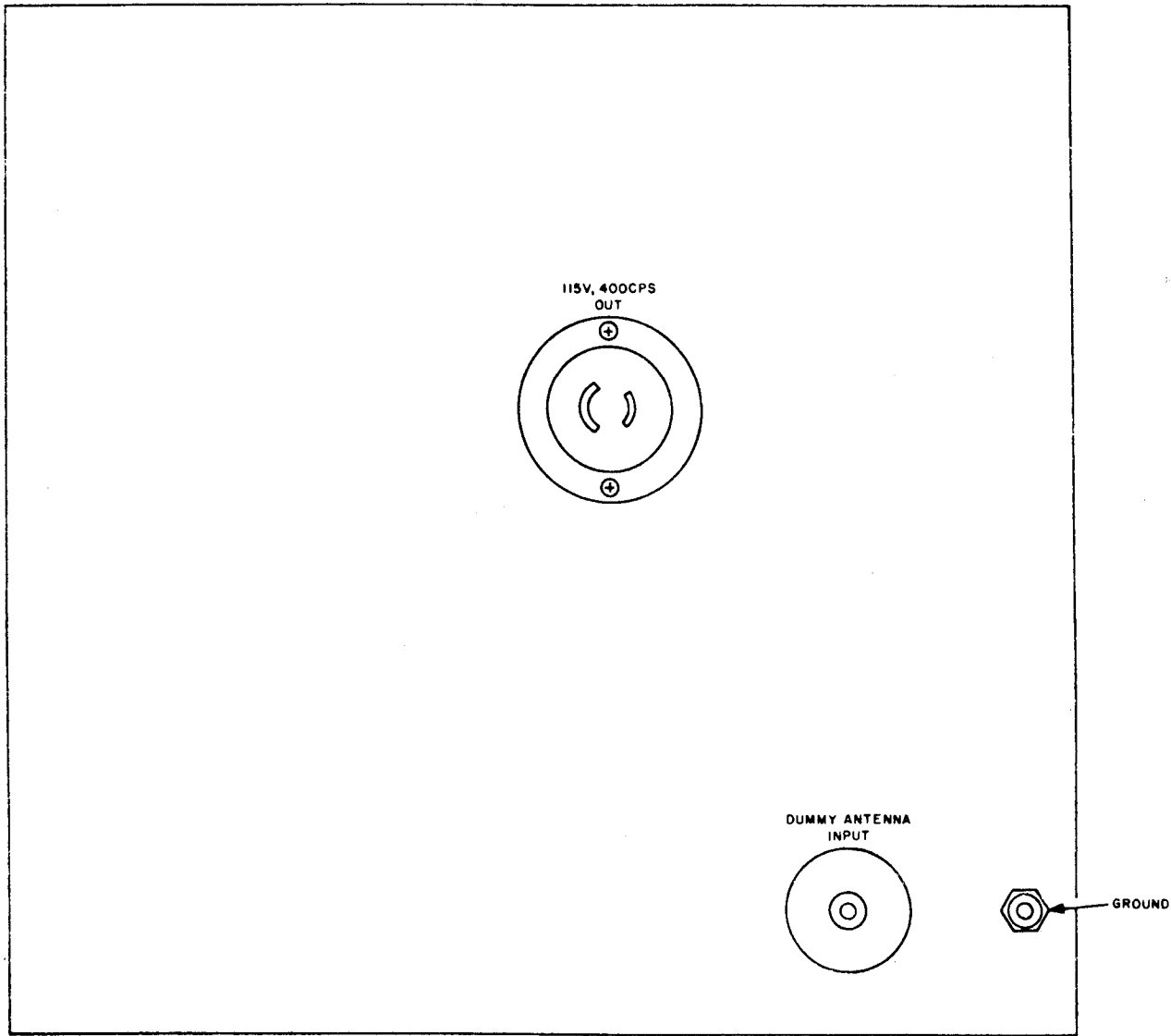

TM6625-622-12-9

Figure 2-4. Test unit rear panel connectors.

2-4. Bench Test Procedures

To perform bench troubleshooting of the receiver-transmitter, perform the preliminary starting procedures in (para 2-5). Refer to TM 11-5821-248-35, for operating and troubleshooting procedures.

2-5. Preliminary Starting Procedures for Test Unit

a. *Control Settings.* Set the test unit controls as follows:

*Note:* Indicator lamps in control unit will not light because no power is supplied to them.

Control	Position
KEY INTLK	BY PASS
AC	OFF
DC POWER	OFF
300Ω AUDIO LOAD	IN
CW KEY	Center (off) position
KEY	Center (off) position
WATTS FORWARD	200
Mode selectm	USB

b. *Bench Test CoNnnections.* Figure 2-5 shows typical bench test setup connections for testing the receiver-transmitter. Connect the appropriate cables as indicated in the following chart.





## CHAPTER 3

### MAINTENANCE INSTRUCTIONS

---

*Note:* The operator will perform operator and organizational maintenance.

#### 3-1. Scope of Maintenance

The maintenance duties assigned to the operator are listed below, together with a reference to the paragraphs covering the specific maintenance functions. The paragraphs include instructions for performing preventive and corrective maintenance. No tools or test equipment other than those listed in the paragraphs are repaired.

- a. Daily preventive maintenance checks and services (para 3-4).
- b. Cleaning (para 3-6).
- c. Monthly preventive maintenance checks and services (para 3-7).
- d. Preservation (para 3-9).
- c. Quarterly preventive maintenance checks and services (para 3-10).

#### 3-2. Tools and Materials Required for Maintenance

The tools and materials required for organizational maintenance are listed below:

- a. Phillip's screwdriver.
- b. Blade screwdriver.
- c. Lint-free cloth.
- d. Sandpaper, extra fine #000.
- e. Small soft-bristled brush.
- f. Rubber electrician's tape.
- g. Materials for repainting (TM 9-213).

#### 3-3. Preventive Maintenance

Preventive maintenance is the systematic care, servicing, and inspection of equipment, to prevent the occurrence of trouble, to reduce

downtime, and to assure that the equipment is serviceable.

a. *Systematic Care.* The procedures given in paragraphs 3-4 through 3-11 cover routine systematic care and cleaning essential to proper upkeep and operation of the equipment.

b. *Preventive Maintenance Checks and Services.* The preventive charts (para 3-5, 3-8, and 3-11) outline functions to be performed at specific intervals. These checks and services maintain Army electronic equipment in good general (physical) condition and in good operating condition. To assist operators in maintaining serviceability, the charts indicate what to check, how to check, and the normal conditions; the *References* column lists the paragraphs or manuals that contain supplementary information. If the defect cannot be remedied by performing the corrective action indicated, higher level maintenance or repair is required. Records and reports of these checks and services must be made in accordance with the requirements set forth in TM 38-750.

#### 3-4. Daily Preventive Maintenance Checks and Services

Preventive maintenance checks and services of the radio set test harness are required daily. A daily period is defined as 8 hours of equipment operation. Paragraph 3-5 specifies checks and services that must be accomplished daily or under the special conditions listed below.

- a. When the equipment is initially installed.
- b. When the equipment is reinstalled after removal for any reason.
- c. At least once each week if the equipment is maintained in a *standby* condition.

3-5. Daily Preventive Maintenance Checks and Services Chart

Seq No.	Item	Procedure	Reference
1	Exterior surfaces	Clean the meter unit panel and the wattmeter glass. Check for broken meter glass.	Para 3-6.
2	Knobs and switches	a. During operation, see that the knobs and switches operate properly. b. Tighten any loose knobs by tightening setscrews with blade screwdriver. c. If trouble remains, contact higher level of maintenance for repair.	
3	Operational test	During operation, be alert for any unusual operating indications. If any unusual indications occur, remove all power and contact higher level of maintenance for repair.	Para 2-5 and 2-6.

3-6. Cleaning

Inspect the exterior of the test unit and the transit case. The exterior surface should be clean and free of dirt, grease, and fungus. Perform the following procedures as specified in the daily preventive maintenance checks and services chart.

**Caution: Do not press on the meter face when cleaning; the meter may become damaged.**

a. Remove all foreign material with a clean lint-free cloth.

b. Remove grease, fungus, and ground-in dirt with a cloth dampened (not wet) with water and a mild soap.

**Caution: Do not use any cleaning solvent on the front panels or silk screening.**

c. Remove dust or dirt from the connectors with a soft-bristled brush.

3-7. Monthly Preventive Maintenance Checks and Services

Perform the maintenance functions indicated in the monthly preventive maintenance checks and services chart (para 3-8) once each month in addition to the daily preventive maintenance checks and services (para 3-5). A month is defined as approximately 30 calendar days of 8-hour-per-day operation. Adjustment of the maintenance interval must be made to compensate for unusual operating conditions. Equipment maintained in a standby (ready for immediate operation) condition must have monthly preventive maintenance checks and services performed on it. Equipment in limited storage (requires service before operation) does not require monthly preventive maintenance.

3-8. Monthly Preventive Maintenance Checks and Services Chart

Seq No.	Item	Procedure	References
1	Cables	Inspect the cables for deterioration and damage, such as cuts, cracks, or frayed insulation. Repair minor damage to insulation by covering the damaged area with rubber electrician's tape. Replace defective cables.	
2	Connectors, jacks, and screws	a. Hand check these exterior connectors, jacks, and screws for looseness. Tighten all loose exterior items. b. See that no screws are loose or missing and tighten all loose screws.	
3	Exterior surfaces	Inspect all exposed metal surfaces for rust and corrosion. Touch up surfaces.	Para 3-9.

3-9. Preservation

Remove rust and corrosion from metal surfaces by lightly sanding them with #000 sandpaper. Brush two thin coats of paint on the bare metal to protect it from further corrosion. Refer to the applicable cleaning and refinishing practices specified in TB Sig 3640.

3-10. Quarterly Preventive Maintenance Checks and Services

Perform the maintenance functions indicated in the quarterly preventive maintenance checks

and services chart (para 3-11) once each 3 months (quarterly interval) in addition to the daily (para 3-5) and monthly (para 3-8) preventive maintenance checks and services. A quarterly interval is defined as 90 calendar days of 8-hour-per-day operation. All deficiencies or shortcomings will be recorded, and those not corrected during the maintenance service and inspection will be immediately reported to higher level maintenance by the use of forms and procedures specified by TM 38-750. Equipment with a deficiency that cannot be corrected at the organizational level should be deadlined in accordance with TM 38-750.

3-11. Quarterly Preventive Maintenance Checks and Services Chart

Seq No.	Item	Procedure	References
1	Completeness	See that the radio set test harness is complete.	Appx III.
2	Publications	Check to see that all pertinent publications are available. The technical manuals must be complete and in usable condition, without missing pages. All changes pertinent to the publications must be on hand.	DA Pam 310-4.
3	Modification work orders	Check to see that all URGENT MWO's have been applied to the equipment and that all NORMAL MWO's have been scheduled.	DA Pam 310-4.

## CHAPTER 4

### SHIPMENT, LIMITED STORAGE, AND DEMOLITION TO PREVENT ENEMY USE

---

#### 4-1. Disassembly of Equipment

Prepare the test harness for shipment and storage as follows:

*a.* Disconnect and roll up the cables and place them in the cable storage space inside the transit case cover.

*b.* Place the cable adapters in the bag provided, place the bag inside the transit case cover, and close the door.

*c.* Place the technical manuals in the compartment inside the lower half of the transit case.

*d.* Place the cover on the lower half of the transit case.

*e.* Secure the four twistlock clamps on the sides of the transit case.

#### 4-2. Repackaging for Shipment and Limited Storage

The exact procedure for repackaging depends on the material available and the conditions under which the equipment is to be shipped (b below) or stored (c below). Adapt the pro-

cedures outlined below whenever circumstances permit.

*a. Material Requirements.* The following materials are required for packaging the test harness for shipment. For stock numbers of materials, consult SB 38-100.

Material	Quantity
Triply fiberboard box	26 x 23 x 22 inches
Polystyrene blocks	6 x 6 inches, 8 each
Nylon tape	10 feet

**Caution:** Be sure the air vent on the end of the transit case is open before packaging for air shipment.

*b. Packaging for Shipment.* See paragraph 2-1 for detailed packaging instructions.

*c. Packaging for Limited Storage.* The transit case provides adequate protection for the other components of the test harness during limited storage. The case is corrosive-resistant and is sealed by a rubber gasket which, with the air vent closed, makes the case interior airtight and moistureproof.

## Section II. DEMOLITION OF MATERIEL TO PREVENT ENEMY USE

#### 4-3. Authority for Demolition

The demolition procedures in paragraph 4-4 will be used to prevent the enemy from using or salvaging this equipment. Demolition of the equipment will be accomplished only upon the order of the commander.

#### 4-4. Methods of Destruction

The tactical situation and time available will determine the method to be used when destruction of equipment is ordered. In most cases, it is preferable to demolish completely some por-

tions of the equipment rather than partially destroy all the equipment units.

*a. Smash.* Smash the interior units of the set; use sledges, axes, hammers, crowbars, and any other heavy tools available.

- (1) Use the heaviest tool on hand to smash the connectors, meters, knobs, dials, and switches.

*Note:* Heavy tools will effectively destroy the external ((1) above), but the remainder of the exposed surfaces of the equipment is constructed of steel plate; attempts to damage it by smashing will be useless.

- (2) Remove the units from the transit case. With a heavy hammer or bar, smash as many of the exposed parts of the chassis as possible.

*b. Cut.* Cut cables and wiring; use axes, handaxes, machetes, and similar tools. Use a heavy axe or machete to cut the cables. Cut all cords and cables in a number of places.

**Warning: Be extremely careful with explosives and incendiary devices. Use these items only when the need is urgent.**

*c. Burn.* Burn the technical manuals first. Burn as much of the equipment as is flammable; use gasoline, oil, flamethrowers, and similar materials. Pour gasoline on the cut cables and internal wiring and ignite it. Use a flamethrower to burn spare parts or pour gasoline on the spares and ignite them. Use incendiary grenades to complete the destruction of the unit.

*d. Explode.* Use explosives to complete demolition or to cause maximum damage, before burning, when time does not permit complete demolition by other means. Powder charges, fragmentation grenades, or incendiary grenades may be used. Incendiary grenades usually are most effective if destruction of small parts and wiring is desired.

- (1) Use a fragmentation grenade to destroy the interior of the radio set test harness. Drop the grenade into the interior of the radio set test harness.

- (2) For quick destruction of the test unit, explode an incendiary grenade on the front panels of the unit.

*e. Dispose.* Bury or scatter destroyed parts or throw them into nearby waterways. This is particularly important if a number of parts have not been completely destroyed.

## APPENDIX I

### REFERENCES

Following is a list of applicable publications available to the organizational repairman of the test harness.

---

<p>DA Pam 310-4 Index of Technical Manuals. Technical Bulletins, Supply Manuals (Types 4, 6, 7, 8, and 9), Supply Catalogs (Type CL), Supply Bulletins, Lubrication Orders, and Modification Work Orders.</p>	<p>TB Sig 364</p>	<p>Field Instructions for Painting and Preserving Electronics Command Equipment.</p>
<p>SB 38-100 Preservation, Packaging, and Packing Materials, Supplies, and Equipment Used by the Army.</p>	<p>TM 11-5821-248-12</p>	<p>Operator and Organizational Maintenance Radio Set AN/ARC-102.</p>
	<p>TM 11-5821-248-35</p>	<p>Direct and General Support and Depot Maintenance Manual Radio Set AN/ARC-102.</p>
	<p>TM 11-6625-623-12</p>	<p>Operator and Organizational Maintenance Manual, Maintenance Kit, Electronic Equipment MK-722/URC.</p>
	<p>TM 38-750</p>	<p>Army Equipment Record Procedures.</p>

## APPENDIX II

## MAINTENANCE ALLOCATION

## Section I. INTRODUCTION

## A2-1. General

a. This appendix assigns maintenance functions to be performed on components, assemblies, and subassemblies by the lowest appropriate maintenance category.

b. Columns in the maintenance allocation chart are as follows:

- (1) *Part or component.* This column shows only the nomenclature or standard item name. Additional descriptive data are included only where clarification is necessary to identify the component. Components, assemblies, and subassemblies are listed in top-down order. That is, the assemblies which are part of a component are listed immediately below that component, and the subassemblies which are part of an assembly are listed immediately below that assembly. Each generation breakdown (components, assemblies, or subassemblies) is listed in disassembly order or alphabetical order.
- (2) *Maintenance function.* This column indicates the various maintenance functions allocated to the categories.
  - (a) *Service.* To clean, to preserve, and to replenish lubricants.
  - (b) *Adjust.* To regulate periodically to prevent malfunction.
  - (c) *Inspect.* To verify serviceability and to detect incipient electrical or mechanical failure by scrutiny.
  - (d) *Test.* To verify serviceability and to detect incipient electrical or mechanical failure by use of special equipment such as gages, meters, etc.
  - (e) *Replace.* To substitute serviceable components, assemblies, or subassemblies, for unserviceable components, assemblies, or subassemblies.
  - (f) *Repair.* To restore an item to serviceable condition through correction of a specific failure or unserviceable condition. This function includes but is not limited to welding, grinding, riveting, straightening, and replacement of parts other than the trial and error replacement of running spare type items such as fuses, lamps, or electron tubes.
  - (g) *Align.* To adjust two or more components of an electrical system so that their functions are properly synchronized.
  - (h) *Calibrate.* To determine, check, or rectify the graduation of an instrument, weapon, or weapons system, or components of a weapons system.
  - (i) *Overhaul.* To restore an item to *completely serviceable* condition as prescribed by serviceability standards developed and published by heads of technical services. This is accomplished through employment of the technique of "Inspect and Repair Only as Necessary" (IROAN). Maximum utilization of diagnostic and test equipment is combined with minimum disassembly of the item during the overhaul process.
  - (j) *Rebuild.* To restore an item to a standard as near as possible to original or new condition in appearance, performance, and life expectancy. This is accomplished through the maintenance technique of complete disassembly of the item, in-

pection of all parts or components, repair or replacement of worn or unserviceable elements using original manufacturing tolerances and/or specifications and subsequent reassembly of the item.

- (3) *Operator, organization, direct and general support, and depot.* The symbol X indicates the category responsible for performing that particular maintenance operation, but does not necessarily indicate that repair parts will be stocked at that level. Categories higher than those marked by X are authorized to perform the indicated operation.
- (4) *Tools required.* This column indicates codes assigned to each individual tool equipment, test equipment, and maintenance equipment referenced. The grouping of codes in this column of the maintenance allocation chart indicates the tool, test, and maintenance equipment required to perform the maintenance function.
- (5) *Remarks.* Entries in this column will

be utilized when necessary to clarify any of the data cited in the preceding column.

c. Columns in the allocation of tools for maintenance functions are as follows:

- (1) *Tools required for maintenance functions.* This column lists tools, test, and maintenance equipment required to perform the maintenance functions.
- (2) *Operator, organization, direct and general support, and depot.* The dagger (†) indicates the categories normally allocated the facility.
- (3) *Tool code.* This column lists the tool code assigned.

#### **A2-2. Maintenance by Using Organizations**

When this equipment is used by signal services organizations organic to theater headquarters or communication zones to provide theater communications, those maintenance functions allocated up to and including general support are authorized to the organization operating this equipment.



## Section II. MAINTENANCE ALLOCATION CHART

PART OR COMPONENT	MAINTENANCE FUNCTION	ECHELON					TOOLS REQUIRED	REMARKS
		O/C	O	DS	GS	D		
TEST HARNESS, RADIO SET AN/URM-157	service	X					4	Continuity of cables Replace fuses, knobs, lamps
	inspect	X						
	test	X					4	
	repair	X					4	
	overhaul				X		1,2,3	
CABLE ASSEMBLY, SPECAIL PURPOSE	test	X					4	Continuity
	replace				X		1	
	repair				X		3	
CASE, TEST HARNESS CY-4064/URM-157	service	X						
	inspect	X						
TEST HARNESS HARNESS SUBASSEMBLY TS-1949/URM-157	repiace				X		3	
	repair				X		3	
TEST HARNESS HARNESS SUBASSEMBLY TS-1949/URM-157	service	X					4	
	inspect	X						
	overhaul						1,2,3	
CONTROL, RADIO SET C-3940/ARC-94	replace				X		3	Refer to TM 11-5821-248-12

### Section III. ALLOCATION OF TOOLS FOR MAINTENANCE FUNCTIONS

TOOLS REQUIRED FOR MAINTENANCE FUNCTIONS	ECHELON					TOOL CODE	REMARKS
	O-C	O	DS	GS	D		
AN/URM-157 (continued)							
MULTIMETER TS-352/U				+	+	1	
MULTIMETER, METER ME-26/U				+	+	2	
TOOL KIT, ELECTRONIC EQUIPMENT TK-100/G				+	+	3	
TOOLS AND TEST EQUIPMENT NORMALLY AVAILABLE TO THE REPAIRMAN- USER BECAUSE OF HIS ASSIGNED MISSION		+				4	

## APPENDIX III

### BASIC ISSUE ITEMS LIST

---

#### Section I. INTRODUCTION

##### A3-1. General

This appendix lists items supplied for initial operation and for running spares. The list includes tools, parts, and material issued as part of the major end item. The list includes all items authorized for basic operator maintenance of the equipment. End items of equipment are issued on the basis of allowances prescribed in equipment authorization tables and other documents that are a basis for requisitioning.

##### A3-2. Columns

Columns are as follows:

*a. Federal stock number.* This column lists the 11-digit Federal stock number.

*b. Designation by model.* Not used.

*c. Description.* Nomenclature or the standard item name and brief identifying data for each item are listed in this column. When requisitioning, enter the nomenclature and description.

*d. Unit of Issue.* The unit of issue is each

unless otherwise indicated and is the supply term by which the individual item is counted for procurement, storage, requisitioning, allowances, and issue purposes.

*e. Expendability.* Nonexpendable items are indicated by NX. Expendable items are not annotated.

*f. Quantity authorized.* Under "Item Comprising an Operable Equipment," the column lists the quantity of items supplied for the initial operation of the equipment. Under "Running Spare Items," the quantities listed are those issued initially with the equipment as spare parts. The quantities are authorized to be kept on hand by the operator for maintenance of the equipment.

*g. Illustration.* The "Item No." column lists the reference designations that appear on the part in the equipment. These same designations are also used on any illustrations of the equipment. The numbers in the "Figure No." column refer to the illustrations where the part is shown.

## SECTION III. FUNCTIONAL PARTS LIST

FEDERAL STOCK NUMBER	DESIGNATION BY MODEL	DESCRIPTION	UNIT OF ISSUE	EXP	QTY AUTH	ILLUSTRATION	
						FIGURE NO.	ITEM NO.
		TEST HARNESS, RADIO SET AN/URM-157: determines forward power from the Receiver-Transmitter, Radio RT-698/ARC-102 checks tuning performance of the antenna couplers; not rated for operating data; multiple item w/carrying case; fiberglass case; 20.2 in lg x 18.68 in w x 16.2 in h; provides interconnecting facilities for the components of the Radio Set AN/ARC-102 and Radio Set AN/MRC-95 and associated equip while under test. Controls the power to the AN/ARC-102 and AN/MRC-95 during test; Collins Radio Co. part No. 522-3400-005 M5AD1-1A					
		ITEMS COMPRISING AND OPERABLE EQUIPMENT					
ORD THRU AGC		TECHNICAL MANUAL TM 11-6625-622-12			2		
5821-953-2209		CONTROL, RADIO SET C-3940U/ARC-94: manual control type power requirements 27.5 vdc; 3600 max range of indicator knob 4.875 in lg b6 5.750 in w by 2.625 in h o/a; panel mounted; Collins Radio Co part No. 522-2457-00					
		TEST HARNESS SUBASSEMBLY TS-1949/URM-157: controls power to Radio Sets AN/ARC-102 and AN/MRC-95 while under test. When necessary cable are added, provides interconnecting facilities for the components of the AN/ARC 102 and AN/MRC-95 during test; Collins Radio Co. part No. 548-8292-005 M5AD1-A13					
		TEST HARNESS SUBASSEMBLY TS-1949/URM-157					
5935-258-7429		ADAPTER UG-201A/U: Collins Radio Co. part No. 357-9291-00			2		
		CABLE ASSEMBLY, RADIO FREQUENCY CG-2727/U: plug UG-88E/U on each end; 5 ft; Collins Radio Co. part No. 543-4334-002 M5AD1-A12			1		
		CABLE ASSEMBLY, SPECIAL PURPOSE, ELECTRICAL CX-8997/URM-157: provides interconnecting facilities from the Receiver-Transmitter, Radio RT-698/ARC-102 to the Test Harness Sub-assembly TS-1949/URM-157; Collins Radio Co. part No. 548-8002-004 M5AD1-A11			1		
		CABLE ASSEMBLY, POWER, ELECTRICAL, BRANCHED CX-8998/URM-157: provides 28 vdc power to the Test Harness, Subassembly TS-1949/URM-157; Collins Radio Co. part No. 761-4969-001 M5AD1-A15			1		

AN/URM-157 1

FEDERAL STOCK NUMBER	DESIGNATION BY MODEL	DESCRIPTION	UNIT OF ISSUE	EXP	QTY AUTH	ILLUSTRATION	
						FIGURE NO.	ITEM NO.
		AN/URM-157 (continued)					
		CABLE ASSEMBLY, SPECIAL PURPOSE, ELECTRICAL CX-8999/URM-157: provides interconnecting facilities from the Test Harness Subassembly TS-1949/URM-157 to the 115v 1 ph 400 cps power source; Collins Radio Co. part No. 548-8035-002 M5AD1-A8			1	1-3	
		CABLE ASSEMBLY, SPECIAL PURPOSE, ELECTRICAL CX-9000/URM-157: connects Power Supply Collins type 516H-1 to the Test Harness Subassembly TS-1949/RUM-157 Collins Radio Co. part No. 548-8003-004 M5AD1-A9			1	1-3	
		CABLE ASSEMBLY, SPECIAL PURPOSE, ELECTRICAL CX-9001/URM-157: connects Radio Set Controls Collins type 714E-1 or 5-2 to the Test Harness Subassembly TS-1949/URM-157; Collins Radio Co. part No. 548-8029-004 M5AD1-A4			1	1-3	
		CABLE ASSEMBLY, SPECIAL PURPOSE, ELECTRICAL CX-9002/URM-157: provides interconnecting facilities from the Control; Radio Set C-3243/ARC-24 to the Test Harness Subassembly TS-1949/URM-157; Collins Radio Co., part No. 548-8284-004 M5AD1-A14			1	1-3	
		CABLE ASSEMBLY, SPECIAL PURPOSE, ELECTRICAL CX-9003/URM-157: provides interconnecting facilities from the Antenna Coupler Collins type 18OR-4 to the Test Harness Subassembly TS-1949/URM-157 when a Collins type 18OR-4 is used; Collins Radio Co. part No. 548-8285-004 M5AD1-A6			1	1-3	
		CABLE ASSEMBLY, SPECIAL PURPOSE, ELECTRICAL CX-9004/URM-157: provides interconnecting facilities from the Control, Antenna Coupler C-4832/TSW to the Test Harness Subassembly TS-1949/URM-157; Collins Radio Co. part No. 548-8286-004 M5AD1-A5			1	1-4	
		CABLE ASSEMBLY, SPECIAL PURPOSE, ELECTRICAL CX-9005/URM-157: provides interconnecting facilities from the Coupler, Antenna CU-1150/ARA-41 to the Test Harness Subassembly TS-1949/URM-157; Collins Radio Co. part No. 548-8287-004 M5AD1-A7			1	1-4	
		CABLE ASSEMBLY, SPECIAL PURPOSE, ELECTRICAL CX-9006/URM-157: provides interconnecting facilities between the Coupler, Antenna CU-351/AR and the Test Harness Subassembly TS-1949/TS-1949/URM-157; Collins Radio Co. part No. 554-2914-004 M5AD1-A10			1	1-4	

31

AN/URM-157

32

FEDERAL STOCK NUMBER	DESIGNATION BY MODEL	DESCRIPTION	UNIT OF ISSUE	EXP	QTY AUTH	ILLUSTRATION	
						FIGURE NO.	ITEM NO.
		AN/URM-157 (continued)					
		CABLE ASSEMBLY, SPECIAL PURPOSE, ELECTRICAL CX-1104/URM-157: provides interconnecting facilities from the controls of the Radio Set AN/MRC-95 to the Test Harness Subassembly TS-1949/URM-157; Collins Radio Co. part No. 761-4970-001 M5AD1-A16			1	1-4	
		CABLE ASSEMBLY, SPECIAL PURPOSE, ELECTRICAL CX-11045/URM-157: provides interconnecting facilities from the Antenna Coupler of the Radio Set AN/MRC-95 to the Test Harness Subassembly TS-1949/URM-157; Collins Radio Co. part No. 761-4971-001 M5AD1-A17			1	1-4	
		CABLE ASSEMBLY, SPECIAL PURPOSE, ELECTRICAL CX-11046/URM-157: provides interconnecting facilities from the Power Inverter-Mounting PP-3702/ARC-102 to the Test Harness Subassembly TS-1949/RUM-157; Collins Radio Co. part No. 756-5248-004 M5AD1-A2			1	1-4	
		CASE, TEST HARNESS CY-4064/URM-157: provides for storage and transit of Test Harness, Radio Set AN/URM-157; Skydyne Inc part No. 625300; Collins Radio Company part No. 021-0257-00 M5AD1-A3			1	1-1	
		RUNNING SPARE ITEMS TEST HARNESS, RADIO SET AN/URM-157  TEST HARNESS SUBASSEMBLY TS-1949/URM-157					
5920-284-6795		FUSE, CARTRIDGE: 10 amp; MIL type FO4A10ROB			3	1-4	F4
5920-296-0679		FUSE, CARTRIDGE: 5 amp; MIL type FO3G5R00A			3	1-4 1-4 1-4	F1, F2, F3

AN/URM-157

By Order of the Secretary of the Army:

**HAROLD K. JOHNSON,**  
*General, United States Army,*  
*Chief of Staff.*

Official:

**J. C. LAMBERT,**  
*Major General, United States Army,*  
*The Adjutant General*

Distribution:

To be distributed in accordance with DA Form 12-36 requirements for Field Maintenance Instructions for CH-47A, CV-2B, CV-7, UH-1B, UH-1D, U-8F, OV-1A, OV-1B, OV-1C and U-10 Aircraft.

