

**TM 11-5820-538-12**  
**DEPARTMENT OF THE ARMY TECHNICAL MANUAL**

---

**OPERATOR AND ORGANIZATIONAL MAINTENANCE MANUAL  
INCLUDING REPAIR PARTS LIST**

**MAST AB-577/GRC  
AND EXTENSION KIT,  
MAST MK-806/GRC**

This copy is a reprint which includes current  
pages from Changes 1 through 3.

---

**HEADQUARTERS, DEPARTMENT OF THE ARMY  
JUNE 1967**

## **WARNING**

**PERSONNEL USING THIS EQUIPMENT SHOULD BE FAMILIAR WITH THE REQUIREMENTS OF TB SIG 291 BEFORE ATTEMPTING INSTALLATION AND DISASSEMBLY OF THE EQUIPMENT COVERED IN THIS MANUAL. FAILURE TO FOLLOW THE REQUIREMENTS OF TB SIG 291 COULD RESULT IN INJURY OR DEATH.**

Change

No. 3

HEADQUARTERS  
DEPARTMENT OF THE ARMY  
WASHINGTON, DC, 21 November 1983

---

**Operator and Organizational  
Maintenance Manual  
MAST AB-577/GRC  
(NSN 5820-00-892-3862)  
AND EXTENSION KIT,  
MAST MK-806/GRC  
(NSN 5985-00-691-2344)**

Current as of February 1983

TM 11-5820-538-12, 13 June 1967, is changed as follows:

1. New or revised material is indicated by a vertical bar in the margin. Where an entire chapter, section, or illustration is added or revised, the vertical bar is placed opposite the identification number and title.

2. Remove and insert pages as indicated below:

*Remove*

None  
1-1 and 1-2  
1-5 and 1-6  
2-1 and 2-2  
2-9 and 2-10  
2-15 and 2-16  
2-19 and 2-20  
Figure 2-18  
3-1 and 3-2  
A-1  
B-3 through B-5

*Insert*

A, B and C  
1-1 and 1-2  
1-5 and 1-6  
2-1 and 2-2  
2-9 and 2-10  
2-15 and 2-16  
2-19 and 2-20  
Figure 2-18 (foldout)  
3-1 and 3-2  
A-1/(A-2 blank)  
B-3 through B-5/(B-6 blank)

3. File this change sheet in front of the publication.

By Order of the Secretary of the Army:

**JOHN A. WICKHAM JR.**  
*General, United States Army  
Chief of Staff*

*Official:*

**ROBERT M. JOYCE**  
*Major General, United States Army  
The Adjutant General*

Distribution:

To be distributed in accordance with DA form 12-51, Operator Maintenance requirements for AB-577/GRC.

By Order of the Secretary of the Army:

**JOHN A. WICKHAM JR.**  
*General, United States Army*  
*Chief of Staff*

Official:

**ROBERT M. JOYCE**  
*Major General, United States Army*  
*The Adjutant General*

**DISTRIBUTION:**

To be distributed in accordance with DA Form 12-51, Operator Maintenance rqrs for  
AB-577/GRC

TECHNICAL MANUAL }  
 No. 11-5820-538-12 }

HEADQUARTERS  
 DEPARTMENT OF THE ARMY  
 WASHINGTON, DC, 13 June 1967

**OPERATOR'S AND ORGANIZATIONAL MAINTENANCE MANUAL**  
**MAST AB-577/GRC (NSN 5820-00-892-3862) AND**  
**EXTENSION KIT, MAST MK-806/GRC (NSN 5985-00-691-2344)**

	Paragraph	Page
CHAPTER 1. INTRODUCTION		
Section I. General		
Scope .....	1-1	1-1
Indexes of publications .....	1-2	1-1
Forms and records .....	1-3	1-1
Reporting of errors .....	1-4	1-1
Reporting equipment improvement recommendations (EIR) .....	1-4.1	1-1
II. Description and Data		
Purpose and use .....	1-5	1-1
Technical characteristics .....	1-6	1-2
Components .....	1-7	1-4
CHAPTER 2. INSTALLATION		
Section I. Service on Receipt of Equipment		
Unpacking .....	2-1	2-1
Checking unpacked equipment .....	2-2	2-1
II. Installation Procedures		
Adjustment of Antenna AT-903/G for polarization and elevation and depression angles .....	2-3	2-4
Layout and installation of guy anchors .....	2-4	2-5
Mounting first mast section and antenna .....	2-5	2-8
Attaching antenna cables to AT-903/G .....	2-6	2-15
Erection of launcher .....	2-7	2-17
Raising mast .....	2-8	2-19
Antenna azimuth adjustment .....	2-9	2-29
T-bar guy assembly placement and adjustment .....	2-10	2-34
Antenna cable connections .....	2-11	2-35
Protecting launcher in frozen ground areas .....	2-12	2-35
CHAPTER 3. MAINTENANCE INSTRUCTIONS		
Section I. Operator's Maintenance		
Scope of operator's maintenance .....	3-1	3-1
Preventive maintenance checks and services periods .....	3-2	3-1
Operator's daily preventive maintenance checks and services chart .....	3-3	3-1
II. Organizational maintenance		
Scope of organizational maintenance .....	3-4	3-1
Organizational monthly preventive maintenance checks and services chart .....	3-5	3-2
Cleaning and Touchup Painting .....	3-6	3-2
CHAPTER 4. DISASSEMBLY, SHIPMENT, AND LIMITED STORAGE		
General .....	4-1	4-1
Mast disassembly .....	4-2	4-1
Packing for shipment or limited storage .....	4-3	4-2
5. DEMOLITION OF MATERIEL TO PREVENT ENEMY USE		
Authority for demolition .....	5-1	5-1
Methods of destruction .....	5-2	5-1

\*This manual together with TM 11-5820-461-12, 25 October 1966, supersedes TM 11-5820-461-10, 22 June 1962, including C 2, 2 December 1963, C 3, 2 July 1964, and C 4, 14 December 1964; and TM 11-5820-461-20, 22 June 1962, including C 1, 28 March 1963.

<b>APPENDIX A. REFERENCES .....</b>	<b>A-1</b>
<b>B. MAINTENANCE ALLOCATION .....</b>	<b>B-1</b>
<b>C. DELETED</b>	



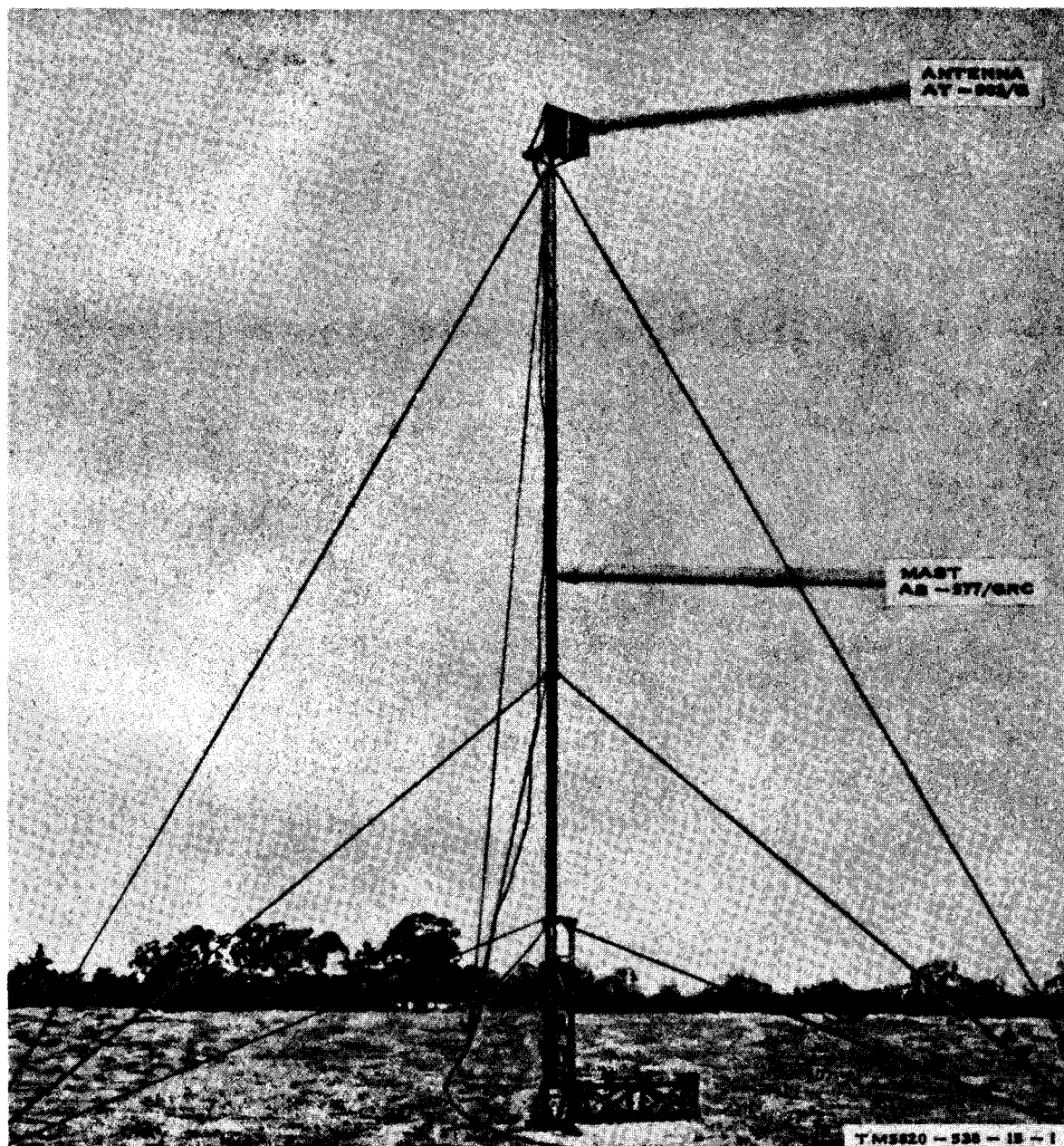
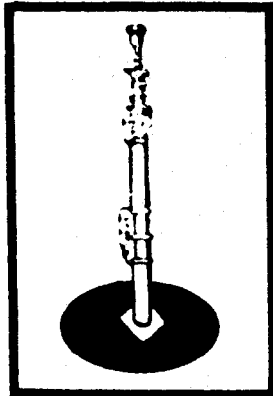

*Figure 1-1. Mast AB-577/GRC, supporting Antenna AT-903/G.*



# FIXED OPERATION WITH LONG RANGE ANTENNAS

## WARNING



TELESCOPING  
ANTENNA MAST



TYPICAL TOWER

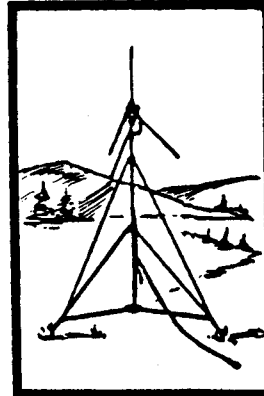

EXTENDED RANGE DOUBLET ANTENNA  
ANTENNA

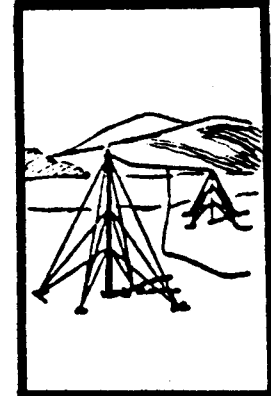

### NEVER ERECT THESE LONG RANGE ANTENNAS DIRECTLY UNDER POWERLINES.

IF YOU MUST ERECT THESE LONG RANGE ANTENNAS NEAR POWERLINES, POWERLINE POLES OR TOWERS, OR BUILDINGS WITH OVERHEAD POWERLINE CONNECTIONS, NEVER PUT THE ANTENNA CLOSER THAN TWO TIMES THE ANTENNA HEIGHT FROM THE BASE OF THE POWERLINE, POLE, TOWER OR BUILDINGS.

### NEVER ATTEMPT TO ERECT ANY LONG RANGE ANTENNA WITHOUT A FULL TEAM.

BEFORE ERECTING ANY LONG RANGE ANTENNA, INSPECT ALL THE PARTS MAKING UP THE ANTENNA KIT. DO NOT ERECT THE ANTENNA IF ANY PARTS ARE MISSING OR DAMAGED.

DO AS MUCH OF THE ASSEMBLY WORK AS POSSIBLE ON THE GROUND.

WHEN ERECTING THE ANTENNA, ALLOW ONLY TEAM PERSONNEL IN THE ERECTION AREA.

MAKE SURE THAT THE AREA FOR THE ANCHORS IS FIRM. IF THE GROUND IS MARSHY OR SANDY, GET SPECIFIC INSTRUCTIONS FROM YOUR CREW CHIEF OR SUPERVISOR ON HOW TO REINFORCE THE ANCHORS.

WHEN SELECTING LOCATIONS FOR ANCHORS, AVOID TRAVELED AREAS AND ROADS. IF YOU CANNOT AVOID THESE AREAS, GET SPECIFIC INSTRUCTIONS FROM YOUR SUPERVISOR AS TO WHAT CLEARANCE YOUR GUY WIRES AND ROPES MUST HAVE OVER THE TRAVELED AREAS AND ROAD.

CLEARLY MARK ALL GUY WIRES AND ROPES WITH THE WARNING FLAGS OR SIGNS SUPPLIED BY YOUR UNIT. IN AN EMERGENCY, USE STRIPS OF WHITE CLOTH AS WARNING STREAMERS.

IF YOU SUSPECT THAT POWERLINES HAVE MADE ACCIDENTAL CONTACT WITH YOUR ANTENNA, STOP OPERATING, ROPE OFF THE ANTENNA AREA, AND NOTIFY YOUR SUPERIORS.

IF THE WEATHER IN YOUR AREA CAN CAUSE ICE TO FORM ON YOUR LONG RANGE ANTENNA AND ITS GUY WIRES AND ROPES, ADD EXTRA GUYS TO SUPPORT THE SYSTEM. ROPE OFF THE AREA AND POST IT WITH WARNING SIGNS LIKE "BEWARE OF FALLING ICE."

DO NOT TRY TO ERECT ANY ANTENNA DURING AN ELECTRICAL STORM.

KEEP A SHARP EYE ON YOUR ANCHORS AND GUYS. CHECK THEM DAILY AND IMMEDIATELY BEFORE AND AFTER BAD WEATHER.



**5**

**SAFETY STEPS TO FOLLOW IF SOMEONE IS THE VICTIM OF ELECTRICAL SHOCK**

**1**

**DO NOT TRY TO PULL OR GRAB THE INDIVIDUAL**

**2**

**IF POSSIBLE , TURN OFF THE ELECTRICAL POWER**

**3**

**IF YOU CANNOT TURN OFF THE ELECTRICAL POWER, PULL, PUSH, OR LIFT THE PERSON TO SAFETY USING A WOODEN POLE OR A ROPE OR SOME OTHER INSULATING MATERIAL**

**4**

**SEND FOR HELP AS SOON AS POSSIBLE**

**5**

**AFTER THE INJURED PERSON IS FREE OF CONTACT WITH THE SOURCE OF ELECTRICAL SHOCK, MOVE THE PERSON A SHORT DISTANCE AWAY AND IMMEDIATELY START ARTIFICIAL RESUSCITATION**

**WARNING**

Adequate ventilation should be provided while using TRICHLOROTRIFLUOROETHANE. Prolonged breathing of vapor should be avoided. The solvent should not be used near heat or open flame, the products of decomposition are toxic and irritating. Since TRICHLOROTRIFLUOROETHANE dissolves natural oils, prolonged contact with skin should be avoided. When necessary use gloves which the solvent cannot penetrate. If the solvent is taken internally, consult a physician.



# CHAPTER 1 INTRODUCTION

## Section I. GENERAL

### 1-1. Scope

This manual describes Mast AB-577/GRC and Extension Kit, Mast MK-806/GRC and covers their installation and organizational maintenance. It includes instructions for cleaning and inspecting the equipment and lists the parts available to the organizational category of maintenance.

### 1-2. Consolidated Index of Army Publications and Blank Forms

Refer to the latest issue of DA Pam 310-1 to determine whether there are new editions, changes or additional publications pertaining to the equipment.

### 1-3. Maintenance Forms, Records, and Reports

*a. Reports of Maintenance and Unsatisfactory Equipment.* Department of the Army forms and procedures used for equipment maintenance will be those prescribed by TM 38-750. The Army Maintenance Management System (TAMMS).

*b. Report of Packaging and Handling Deficiencies.* Fill out and forward SF 364 (Report of Discrepancy (ROD)) as prescribed in AR 735-11-2/DLAR 4140.55/NAVMATINST 4355.73A/AFR 400-54/MCO 4430.3F.

*c. Discrepancy in Shipment Report (DISREP) (SF 361).*

Fill out and forward Discrepancy in Shipment Report (DISREP) (SF 361) as prescribed in AR 55-38/NAVSUPINST 4610.33C/AFR 75-18/MCO P4610.19D/DLAR 4500.15.

### 1-4. Reporting Errors and Recommending Improvements

You can help improve this manual. If you find any mistakes or if you know of a way to improve the procedures, please let us know. Mail your letter or DA Form 2028 (Recommended Changes to Publications and Blank Forms) direct to: Commander, US Army Communications-Electronics Command and Fort Monmouth, ATTN: DRSEL-ME-MP, Fort Monmouth, New Jersey 07703. In either case, a reply will be furnished direct to you.

#### 1-4.1 Reporting of Equipment Improvement Recommendations (EIR)

If your AB-577/GRC and/or MK-806/GRC needs improvement, let us know. Send us an EIR. You, the user, are the only one who can tell us what you don't like about your equipment. Let us know why you don't like the design. Put it on an SF 368 (Quality Deficiency Report). Mail it to Commander, US Army Communications-Electronics Command and Fort Monmouth, ATTN: DRSEL-ME-MP, Fort Monmouth, New Jersey 07703. We'll send you a reply.

## Section II. DESCRIPTION AND DATA

### 1-5. Purpose and Use

*a.* Mast AB-577/GRC (fig. 1-1) is an eight-section antenna support that can be extended as high as 48 feet (14.63 meters) above the ground. Extension Kit, Mast MK806/GRC is a five-section mast kit that is mounted on top of the AB-577/GRC to produce a total height of 75 feet (22.86 meters).

#### WARNING:

The use of more than one 25-foot mast extension kit (MK-806/GRC) on the Antenna

Mast AB-577/GRC is hazardous and is not authorized.

*b.* In some applications, the AB-577/GRC supports Antenna AT-903/G, a born-type directional antenna. The AB-577/GRC (and the MK-806/GRC) may be used to support two AT-903/K's when they are mounted on Support Antenna AB-720/G (fig. 1-2), which is part of Radio Set Group AN/TRA-24A (for F-band operation of Radio Set AN/TRC-24), and Radio Set Group OA-3668/A/TRC-24 (for J-band operation of the AN/TRC-24). Refer to TM 11-5820-287-12 and TM 11-5820-287-34 for additional information on the AN/TRC-24 series of radio sets.

c. The AB-577/GRC may also be used to support two AB-903/G's when they are mounted on Support, Antenna AB-957/GRC fig. 1-3). The AB-957/GRC is similar to the AB-720/G; however, one of the antennas mounted on it can be rotated after the mast is erected, for more accurate positioning. Rotation is done on the ground, using two guys to pull the movable antenna into the desired direction. The guys are then tied down to prevent further turning of the antenna. The AB-957/GRC is normally a part of Army Area Communications Systems assemblages.

d. The AB-720/GRC and the AB-957/GRC are commonly referred to as *T-bars*.

### 1-6. Technical Characteristics

#### a. AB-577/GRC.

Type .....	Sectionalized, tubular.
Material .....	Aluminum.
Height:	
Maximum expanded .....	48 feet (14.63 meters).
Collapsed (launcher height) .....	95 inches (2.41 meters).
Each mast section .....	5 feet (1.52 meters).
Guy rope lengths .....	39 ft, 47 ft, and 56 ft (11.88, 14.32, and 17.07 meters, respectively).
Stability .....	±5 percent of original setting for winds up to 75

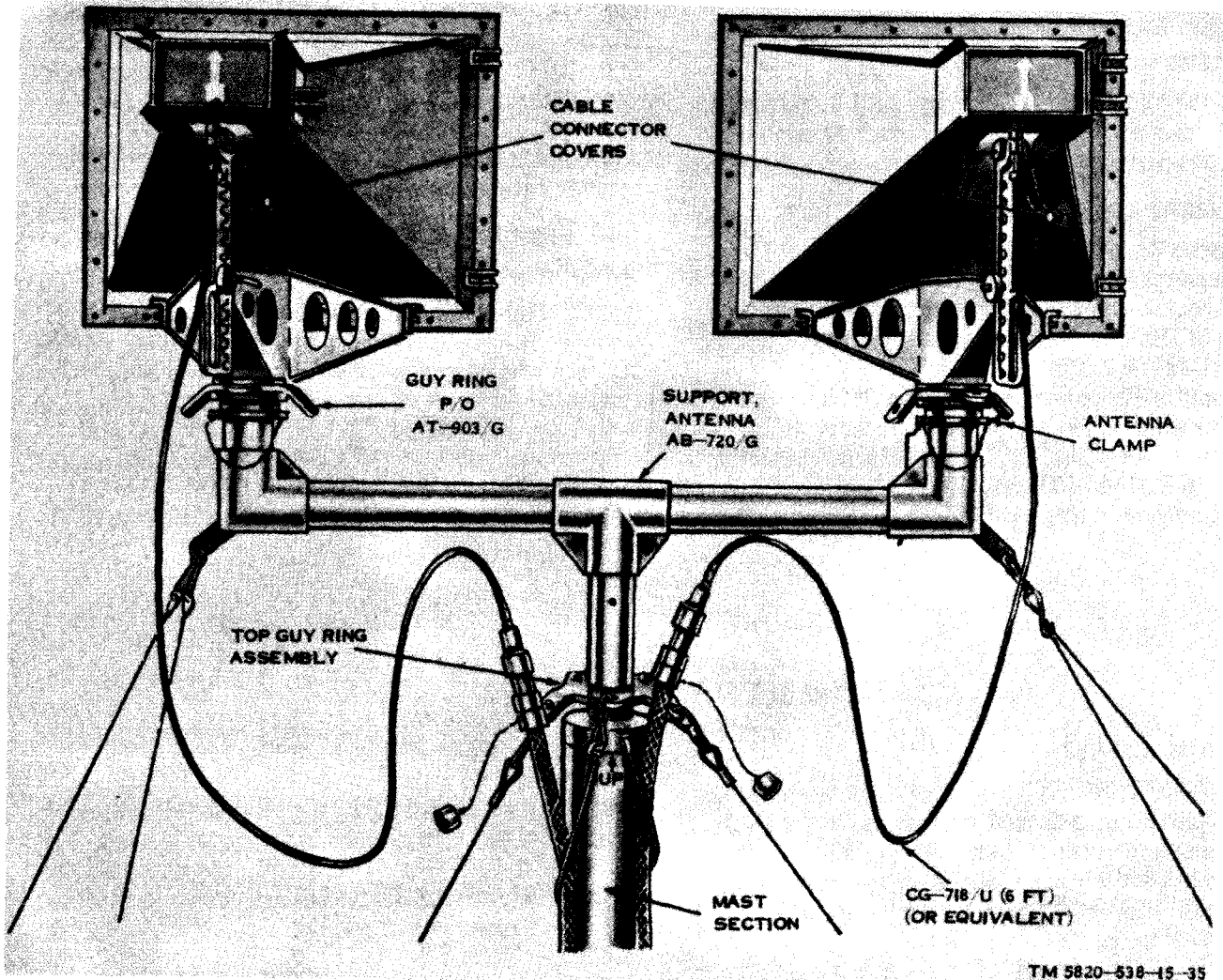

TM 5820-538-15-35

Figure 1-2. Support, Antenna AB-720/G in use.

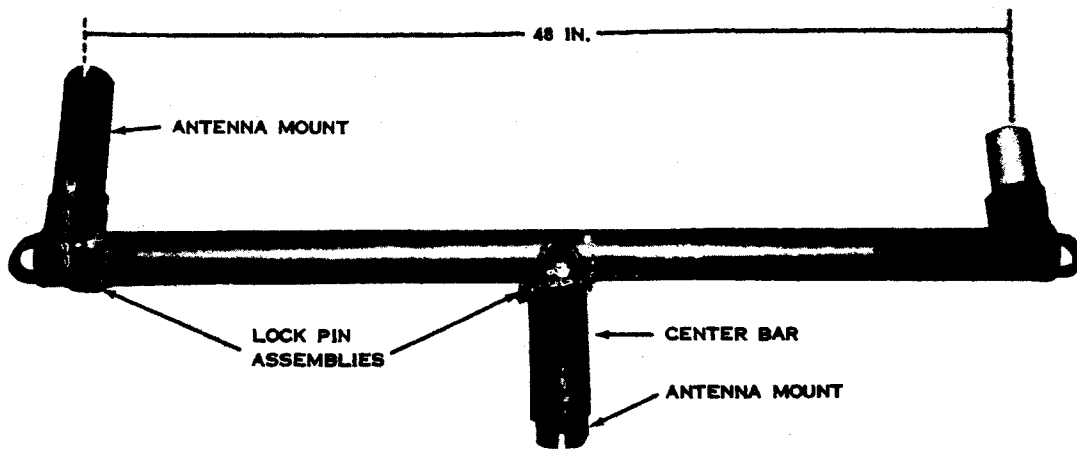

A. PREPARED FOR SHIPMENT.

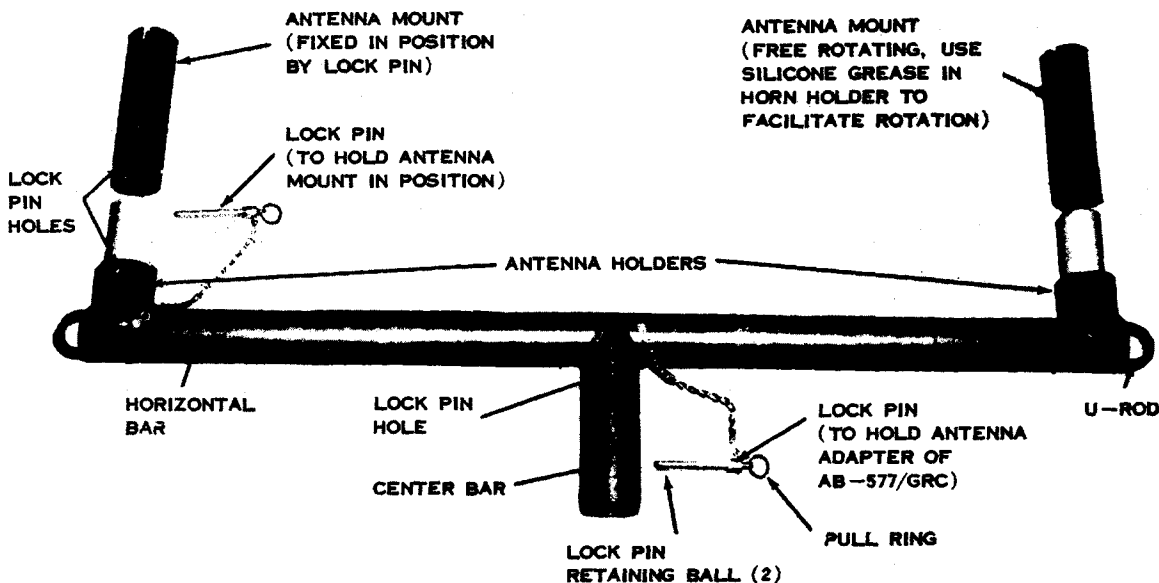

B. PARTS LOCATION.

TM 5820-338-15-36

Figure 1-3. Support, Antenna AB-957/GRC.

miles per hour (65.13 knots; 120.87 kilometers per hour), under conditions of 1/2 inch (1.27 centimeters) ice loading.

Rotation ----- Azimuth rotation, 360°; controlled from ground.

b. MK-806/GRC.

Type ----- Sectionalized, tubular.  
Material ----- Aluminum

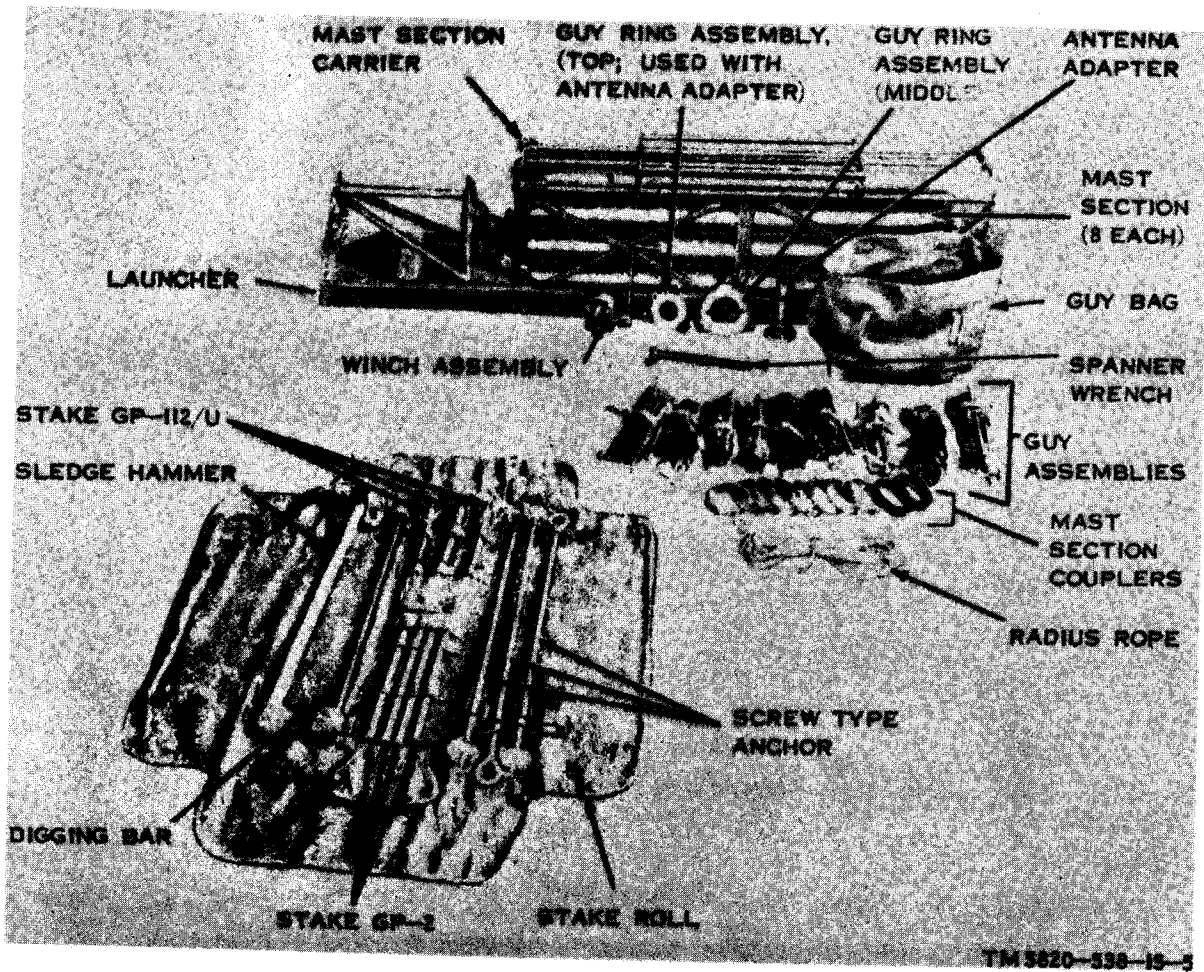

TM 5820-538-12-3

Figure 1-4. Mast AB-577/GRC, components.

Height:	
Maximum expanded.	25 ft (7.62 meters).
Each mast section --	5 ft (1.52 meter).
Guy rope lengths -----	78 ft and 98 ft (23.77 and 29.87 meters, respectively).

### 1-7. Components

The components of the AB-577/GRC (fig. 1-4) and the MK-806/GRC (fig. 1-5) are following tables 1-1 and 1-2, respectively.



**Table 1-1. Components of Mast AB-577/GRC**

<i>Component</i>	<i>Qty</i>	<i>National Stock No.</i>
Mast AB-577/GRC (fig. 1-4) (This item is nonexpendable)		5820-00-892-3862
TM 11-5820-538-12	1	
Adapter, antenna: 80063; SM-C-423587	1	5820-00-973-0200
Anchor, guy (screw anchor): 80063; SC-B-423652	3	4030-00-580-7833
Roll, tools and accessories (stake roll): 80063; SM-D-423619	1	5140-00-973-0491
Bag, cotton duck: 80063; SM-C-423628	1	5820-00-973-0349
Bar, digging: 80063; SM-B-423624	1	5120-00-892-4713
Bar, claw (mast coupler tool): 80063; SM-423604 (fig. 4-1)	1	5820-00-973-0352
Carrier assembly (mast section carrier): 80063; SM-D-423552	1	5820-00-973-0350
Clamp, rim clenching (mast section coupler): 80063; SM-C-423646	8	5340-00-973-0230
Guy assembly (39 ft): 80063; SM-D-423651	3	5975-00-715-0361
Guy assembly (47 ft): 80063; SM-D-423650	3	5975-00-714-8834
Guy assembly (65 ft): 80063; SM-D-423651	3	5975-00-715-7932
Guy attachment, top (guy ring assembly): 80063; SM-C-423561	1	4030-00-973-0189
Guy attachment, middle (guy ring assembly): 80063; SM-D-423560	1	4030-00-973-0188
Halyard, antenna (radius rope): 80063; SM-B-423575	1	5820-00-973-0298
Hammer, 6 lb: 80063; SM-C-540011-1	1	5120-00-265-7462
Mast base (launcher): 80063; SM-D-423551	1	5820-00-973-0351
Mast section: 80063; SM-D-423556	8	5985-00-400-7274
Stake, Guy GP-2: 80063; SC-B-61956	4	4030-00-187-5261
Stake, Guy GP-112	3	4030-00-291-9354
Winch assembly: 80063; SM-C-423630; includes:	1	3950-00-973-0258
1 ea. Crank handle: 80063; SM-C-423574A		3950-00-954-0526
1 ea. Gear assembly: 80063; SM-C-540000		3010-00-135-2491
Wrench, spanner: 80063; SM-C-423605	1	5120-00-973-0257

**Table 1-2. Extension Kit, Mast MK-806/GRC**

<i>Component</i>	<i>Qty</i>	<i>National Stock No.</i>
Extension Kit, Mast MK-806/GRC (This item is nonexpendable) (fig. 1-5)		5985-00-691-2344
Anchor guy (screw anchor): 80063; SM-B-423652	3	4030-00-580-7833
Bag BG-102A	1	8105-00-497-9628
Case, Mast Extension CY-4507/GRC	1	5985-00-226-6230
Coupling, grooved (mast section coupler): 80063; SM-C-423646	5	5340-00-973-0230
Guy attachment (guy ring assembly): 80063; SM-D-423560	1	4030-00-973-0188
Guy assembly (98 ft lg): 80063; SM-D-424072	3	5445-00-892-9624
Guy assembly (78 ft lg): 80063; SM-D-424071	3	5445-00-892-9625
Mast section: 80063; SM-D-423556	5	5985-00-400-7274
Stake, Guy GP-112	3	4030-00-291-9354

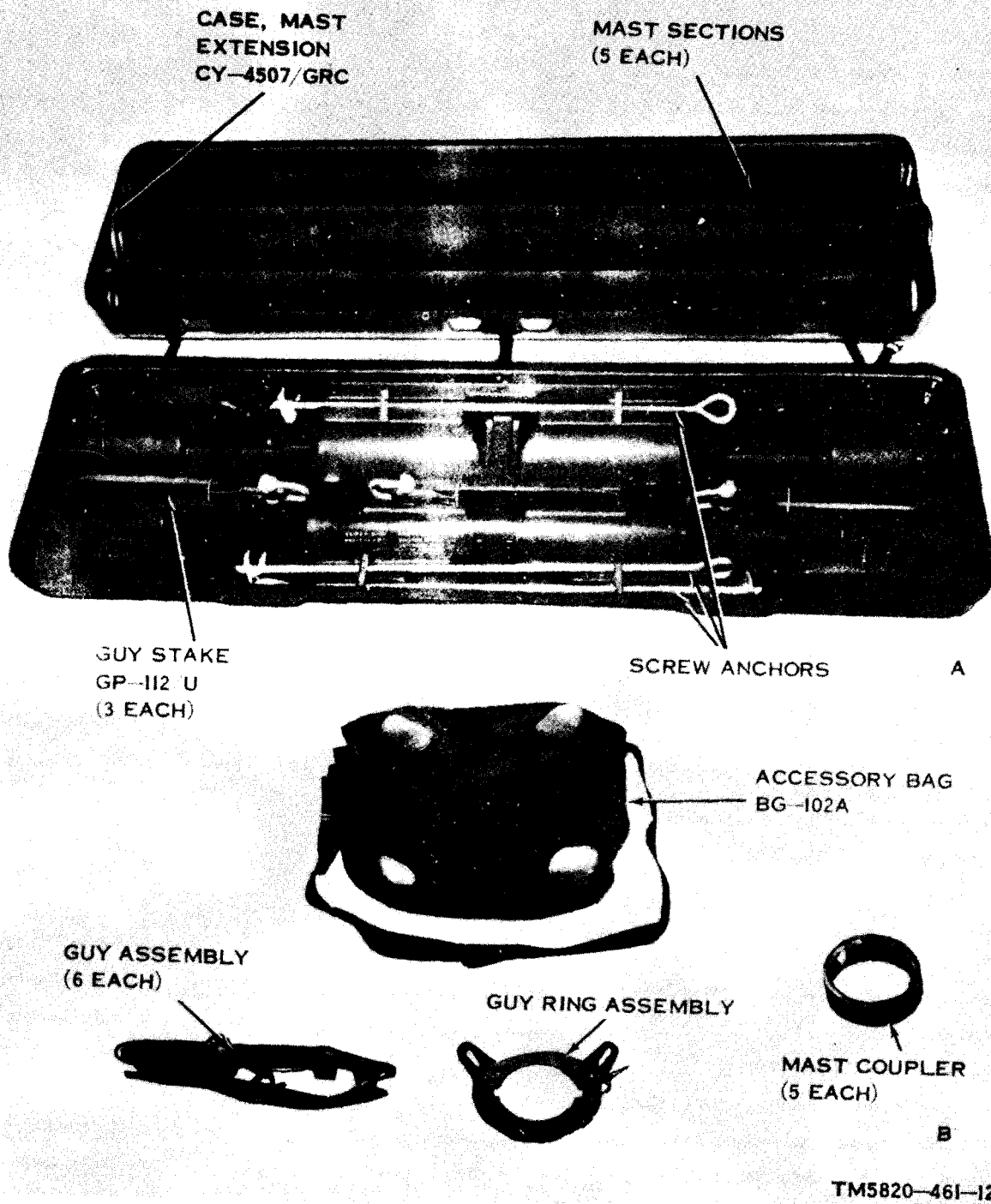

Figure 1-5. Extension Kit, Mast MK-806/GRC, components.

## CHAPTER 2 INSTALLATION

### SECTION I. SERVICE ON RECEIPT OF EQUIPMENT

#### i. Unpacking

a. *Packaging Data.* When packed for shipment, the components of the AB-577/GRC are packed in wooden boxes or crates as shown in figures 2-1 through 2-3. The components of the MK-806/GRC are packed in a similar manner. The packaging data is given in the following chart:

Box No.	Package dimensions	Volume (cu ft)	Unit weight (lb)	Contents of box
<b>AB-577/GRC:</b>				
1 of 3 .....	24½ x 14½ x 15½ .....	3.19	72	Guy bag and contents.
2 of 3 .....	40½ x 13 x 6 .....	1.83	58	Stake roll and contents.
3 of 3 .....	97⅞ x 16 9/16 x 28 9/16 .....	12.89	197	Launcher and mast carrier.
Total weight, AB-577/GRC .....			327	
<b>MK-806/GRC:</b>				
1 of 2 .....	65½ x 18¼ x 12¾ .....	8.82	94	Case, Mast Extension CY 4507/GRC and contents.
2 of 2 .....	22 x 18½ x 16 .....	377	42	Accessory Bag BG-102A and contents.
Total weight, MK-806/GRC .....		136		
Total weight .....		463		

b. *Removing Contents.* When unpacking equipment from wooden boxes, proceed as follows:

**WARNING**

Prevent personal injury when applying or removing steel strapping by wearing heavy gloves and a protective faceshield. Do not handle packing cartons by the steel strapping.

**CAUTION**

Do not attempt to pry off the tops of the boxes. Damage to the equipment will result.

(1) Remove the nails or staples that are driven through the wires that hold the covers closed. Use a nailpuller.

(2) Carefully raise the cover, and fold it back.

(3) Lift the guy bag and stake roll of the box.

(4) To unpack the launcher and mast section carrier, pull out the screwdrive nails, six from the front of the crate, and six from the rear.

(5) Remove the wooden blocks that were held in place by the screwdrive nails.

(6) Lift the assembly from the crate.

**NOTE**

If possible, save the wooden boxes and crates for future use in packing for shipment or limited storage.

#### 2-2. Checking Unpacked Equipment

a. Inspect the equipment for possible damage incurred during shipment. If damage is present, report it as instructed in paragraph 1-3b

b. Check to see that the equipment is complete as listed on the packing slip. If a packing slip is not available, check the equipment against the basic issue items list (app. B). Report all discrepancies in accordance with TM 38-750. Shortage of a minor assembly or part that does not affect proper functioning.

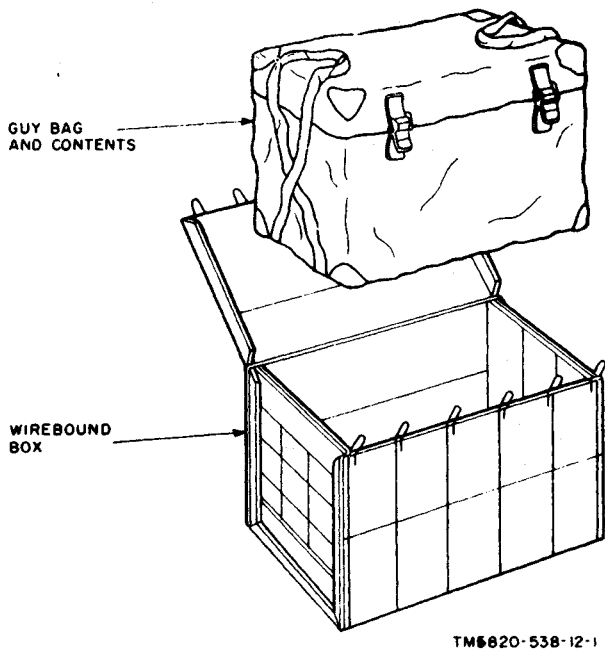

Figure 2-1. Typical packaging, guy bag.

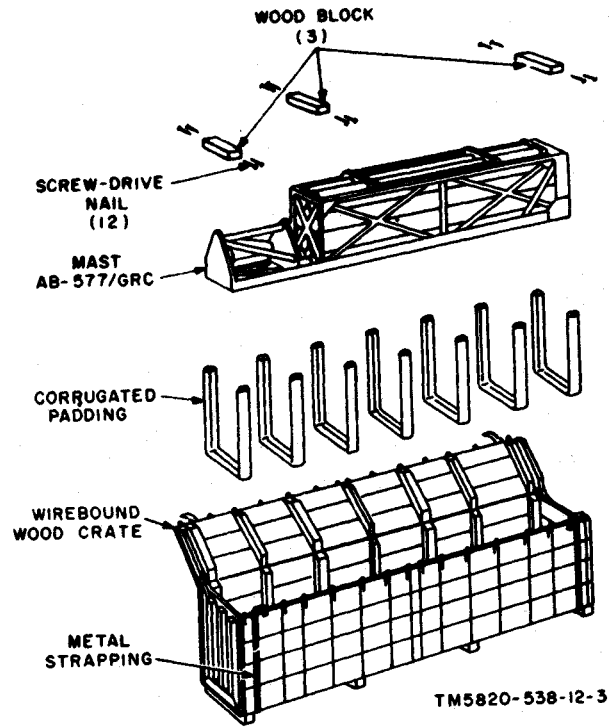

Figure 2-3. Typical packaging, launcher and mast section carrier.

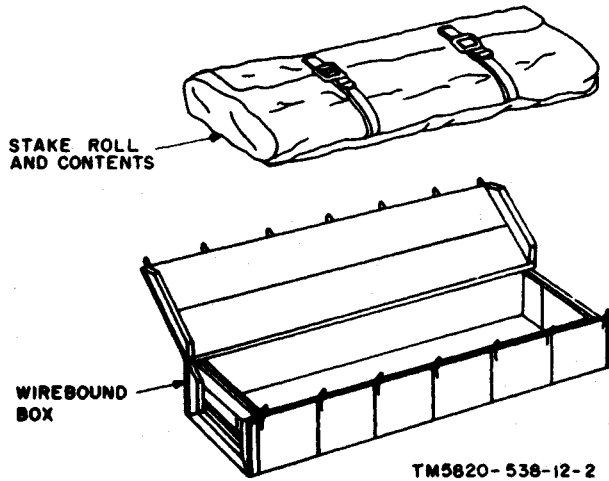

Figure 2-2. Typical packaging, stake roll.

of the equipment should not prevent use of the equipment.

c. If the equipment has been used or reconditioned, see whether it has been changed by a MWO. If the equipment has been modified, the MWO number will appear on the container. Check to see whether the MWO number (if any) and appropriate notations concerning the modification have been entered in the equipment manual.

Note. Current MWO's applicable to the equipment are listed in DA Pam 310-4.

## Section II. INSTALLATION PROCEDURES

**Warning:** During installation of this equipment, conform to all safety requirements set forth in TB SIG 291. Injury or DEATH could result from failure to comply with safe practices. In addition to at least two men erecting the mast, there should be at least three or more men available to hold the ends of the guys while the mast is being erected, particularly when the ground is wet, frozen, or slippery, and when the winds are blowing at a rate greater than 15 miles per hour (13 knots; 24 kilometers per hour).

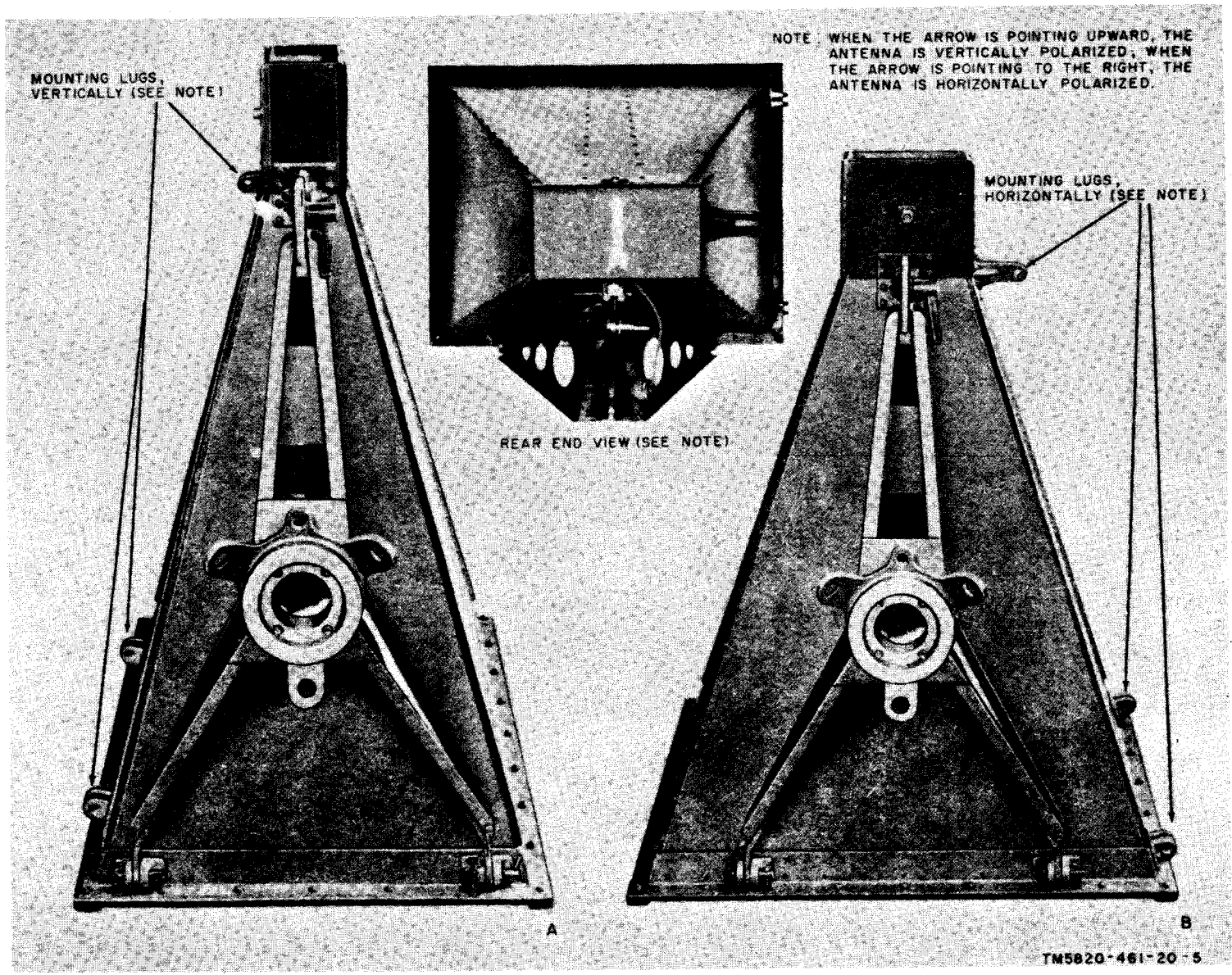

Figure 2-4. Antenna AT-903/G, mounting details.

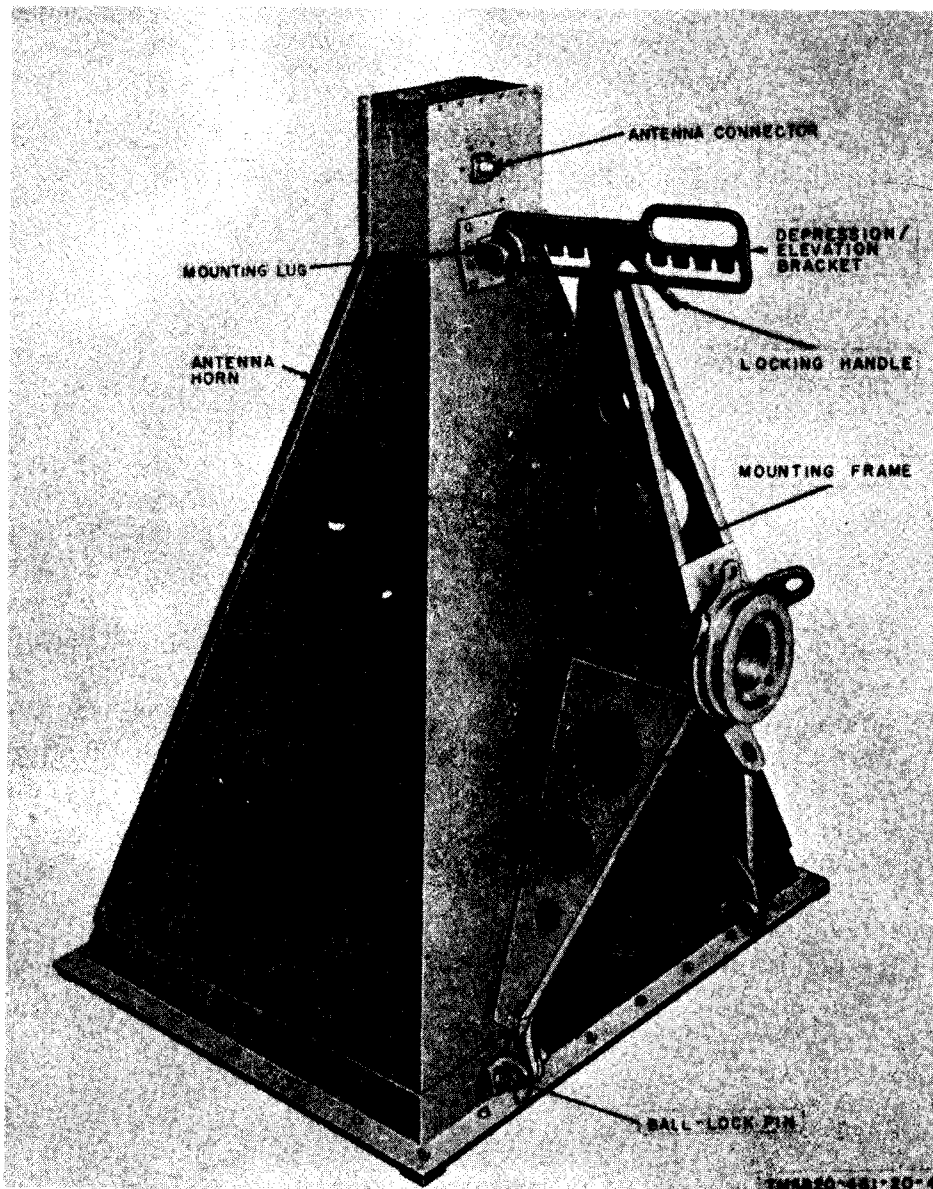

Figure 2-5. Antenna AT-903/G, location of components.

**2-3. Adjustment of Antenna AT-903/G for Polarization and Elevation and Depression Angles**

(figs. 2-4 and 2-5)

Antenna AT-903/G is provided with a removable three-legged mounting frame (fig. 2-4), which is attached to the antenna horn for either horizontal or vertical polarization, and also provides for adjustment of the angle

(elevation and depression) at which the antenna horn is set with respect to the ground. Poor communication during radio operation may require that the antenna angle of elevation or depression be changed or that the antenna be changed to the opposite polarization.

a. *Polarization Adjustment* (fig. 2-4). Note that for vertical polarization the mounting

legs are mounted on the same side of the antenna horn as the antenna connector. Some AT-903/G's are marked with an arrow, showing by its direction whether the antenna polarization is vertical to or parallel with the ground. Refer to the radio site installation instructions for polarization requirements.

- (1) To detach the mounting frame from the antenna horn, pull the three ball lockpins from their holes (fig. 2-5).
- (2) Set the mounting frame on the antenna horn in the desired polarization. Align the holes in the legs of the mounting frame with the holes in the mounting lugs, and insert the ball lockpins.

*b. Elevation and Depression Adjustment* (fig. 2-5). Refer to the radio installation instructions, which should state the angle at which the antenna horn should be set. The depression/elevation bracket is slotted at 2° intervals; the zero (0) slot provides for the antenna to be parallel to the ground.

- (1) Loosen the locking handle.
- (2) Grasp the depression/elevation bracket; lift it to disengage the slot. Move the mounting frame to the proper slot for elevation or depression angle.
- (4) Tighten the locking handle.
- (3) Push the depression/elevation bracket down to engage the selected slot.

**2-4. Layout and Installation of Guy Anchors**

*a. Required Items.* For installation of the AB-577/GRC, with or without the MK-806/GRC, select the radius rope, the digging bar, and the hammer. Depending on the condition of the soil, select either stakes GP-112/U or the screw-type anchors. For normal soil conditions, use the screw-type anchors. If the ground is composed of shale, sandstone, soft rock, ice, etc., use the GP-112/U's. In some cases, small trees, large rocks, stumps, etc., may be used as guy anchors.

*b. Procedure for Location of Guy Anchors* (fig. 2-6). Mark the location for the AB-577/GRC guy anchors, using the procedures given in (1) below. When the MK-806/GRC

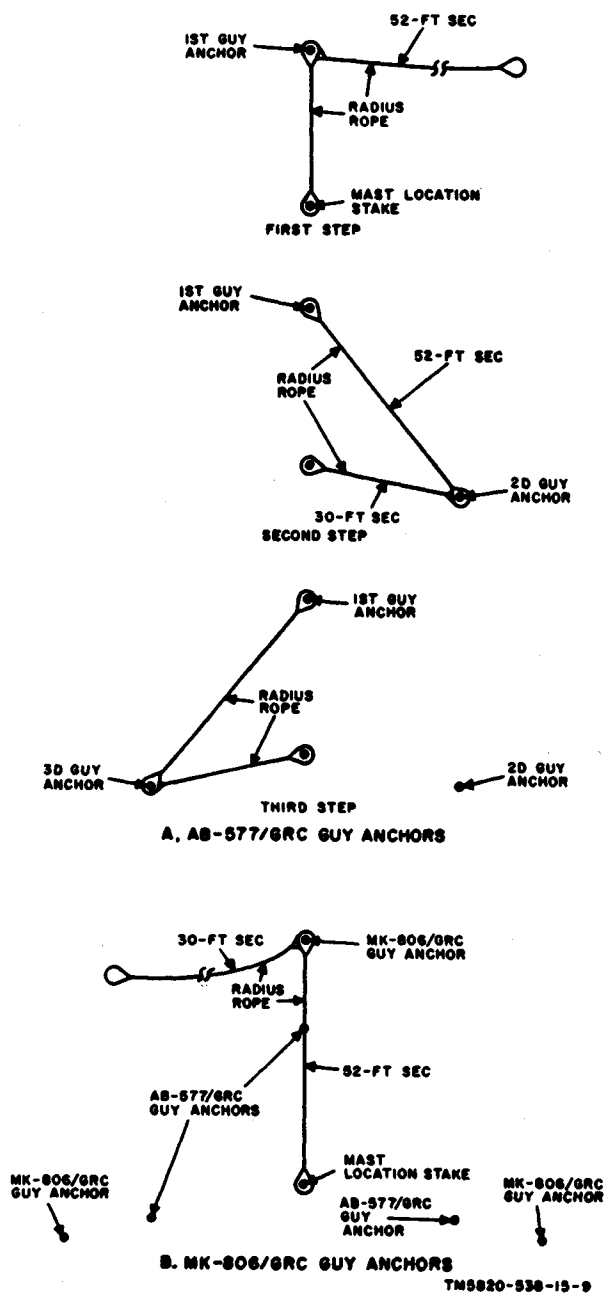

Figure 2-6. Layout of guy anchor positions.

is used, proceed to (2) below after the procedures in (1) below are completed. If necessary, the location of the guy anchors may be located up to 5 feet farther from the mast if obstructions prevent their being located as shown. The guy assemblies are long enough to reach the added distance. Use Stakes GP-2,



*Figure 2-7. Use of digging bar with screw-type guy anchor.*

driven about 3 inches into the ground, to mark the positions of the guy anchors and the mast.

*Notes.* The radius rope has a loop at each end and a loop where the 30-foot and 52-foot sections join (A, fig. 2-6).

(1) When only the AB-577/GRC is to be

used, proceed as follows:

- (a) Mark the proposed mast position with a GP-2.
- (b) Put the loop at the end of the 30-foot section of the radius rope over



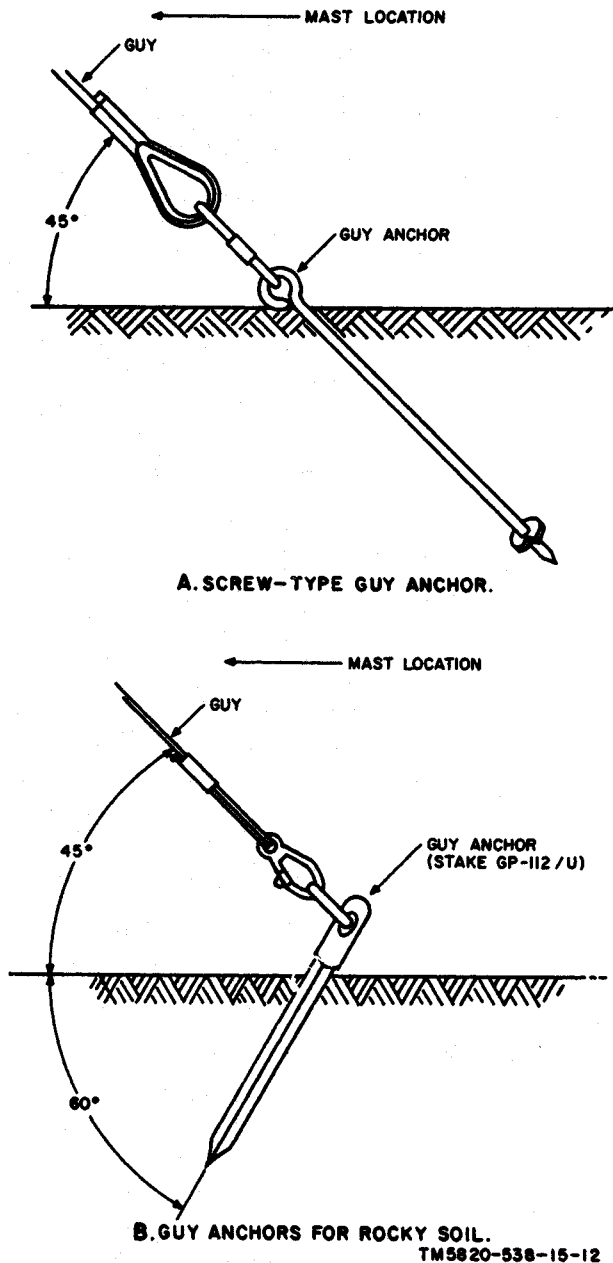

Figure 2-8. Guy anchors installed in earth.

- the mast location stake, and mark the position of the first guy anchor 30 feet away (first step, A, fig. 2-6).
- (c) Leave the end of the 30-foot section of the radius rope on the *mast location stake*, and put the loop at the end of the 52-foot section over the marker stake for the *first guy*

*anchor*. Take the remaining loop in the radius rope. Stretch both sections of the rope, and mark the second guy anchor position (second step, A, fig. 2-6).

- (d) Leaving the ends of the radius rope looped over the same two stakes, stretch it in the other direction and mark the third guy anchor position (third step, A, fig. 2-6).
- (2) When the MK-806/GRC is to be added to the AB-577/GRC, refer to B, figure 2-6 and proceed as follows, after the guy anchor locations for the AB-577/GRC ((1) above) have been completed. Loop the end of the 52-foot section of the radius rope over the mast location stake. Mark the position of the three guy anchors for the MK-806/GRC in line with the AB-577/GRC guy anchor locations, 52 feet from the mast location stake.

c. Installation of Guy Anchors.

- (1) When using screw-type anchors:
- (a) Loosen the earth's surface with the digging bar to help start the guy anchor.
  - (b) Insert the digging bar through the anchor eye, and use the bar for leverage to screw the anchor into the earth (fig. 2-7).
  - (c) Start the anchor vertically into the earth, then slant the top of the rod approximately 45° toward the mast base location (A, fig. 2-8).
  - (d) Screw the anchor into the earth until the eyelet is at ground level.
- (2) When using GP-112/U stakes for rocky soil:
- (a) Use the digging bar and hammer to drive a hole for the stake no wider or deeper than necessary. The slope of the hole should be at approximately a 60° angle, *slanted away from the mast base location* (B, fig. 2-8).

- (b) Drive the stake into the hole until the eyelet is at ground level. If the stake fits loosely in the hole, pack the hole with earth.

**2-5. Mounting First Mast Section and Antenna**

After the guy anchors have been installed (para 2-4), set up the first mast section in the launcher and mount the antenna on it.

*a. Launcher Preparation.*

- (1) Open the catches that hold the mast section carrier in the launcher frame (fig. 2-9), and lift the mast section carrier out of the launcher frame (fig. 2-10).
- (2) Remove the mast location stake (A, fig. 2-6). Position the launcher so that it is lying on the ground, with the center of its base at the stake location, and with the top of the launcher facing midway between the second and third guy anchors.
- (3) Remove one mast section from the mast section carrier; set it aside.
- (4) Lift the top end of the launcher, and set the mast section carrier under it (fig. 2-11).

*b. Mounting First Mast Section.*

- (1) Remove the winch locking pin from the rear of the elevator platform (A, fig. 2-12⊙); secure the pin to the platform to prevent tangling during assembly.
- (2) Remove the locking pin from the handbrake handle, and open the handbrake.
- (3) Insert the mast section that was previously set aside, bottom first through the top of the launcher (B, fig. 2-12⊙).

*Note.* The top of the mast section is identified by the word *UP* and an arrow. The bottom of the mast section has an arrow pointing to the key in the bottom.

- (4) Remove the locking pin from the locking bar of the winch cable reel (A, fig. 2-12⊙), and lock the bar in the open position.
- (5) Slightly lower the elevator platform on the launcher. Push the mast section in until it meets the elevator base bearing. Lock the handbrake.

*c. Mounting a Single AT-903/G.*

- (1) Check the AT-903/G polarization and the depression/elevation setting (para 2-3); adjust as necessary (fig. 2-13).

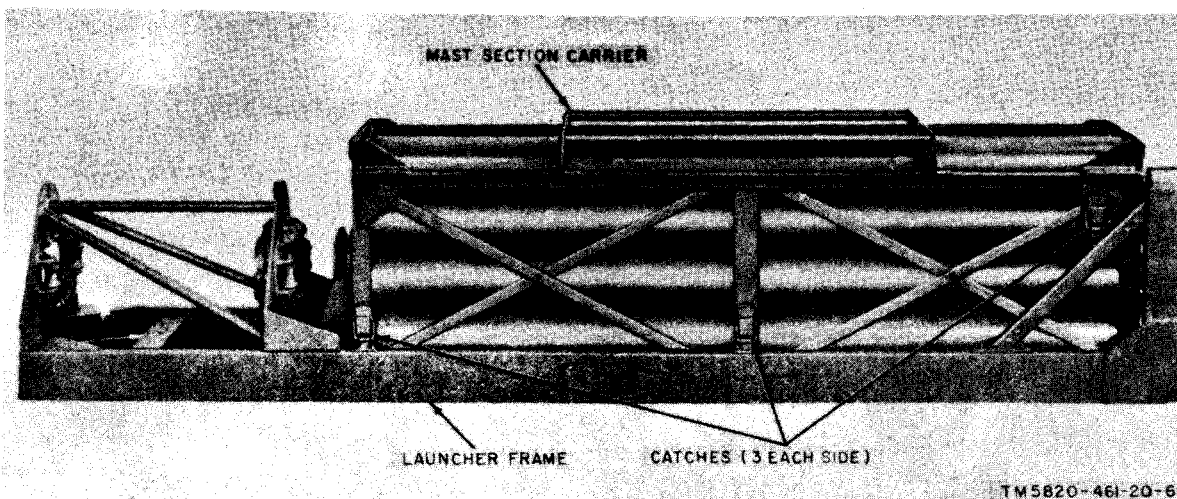
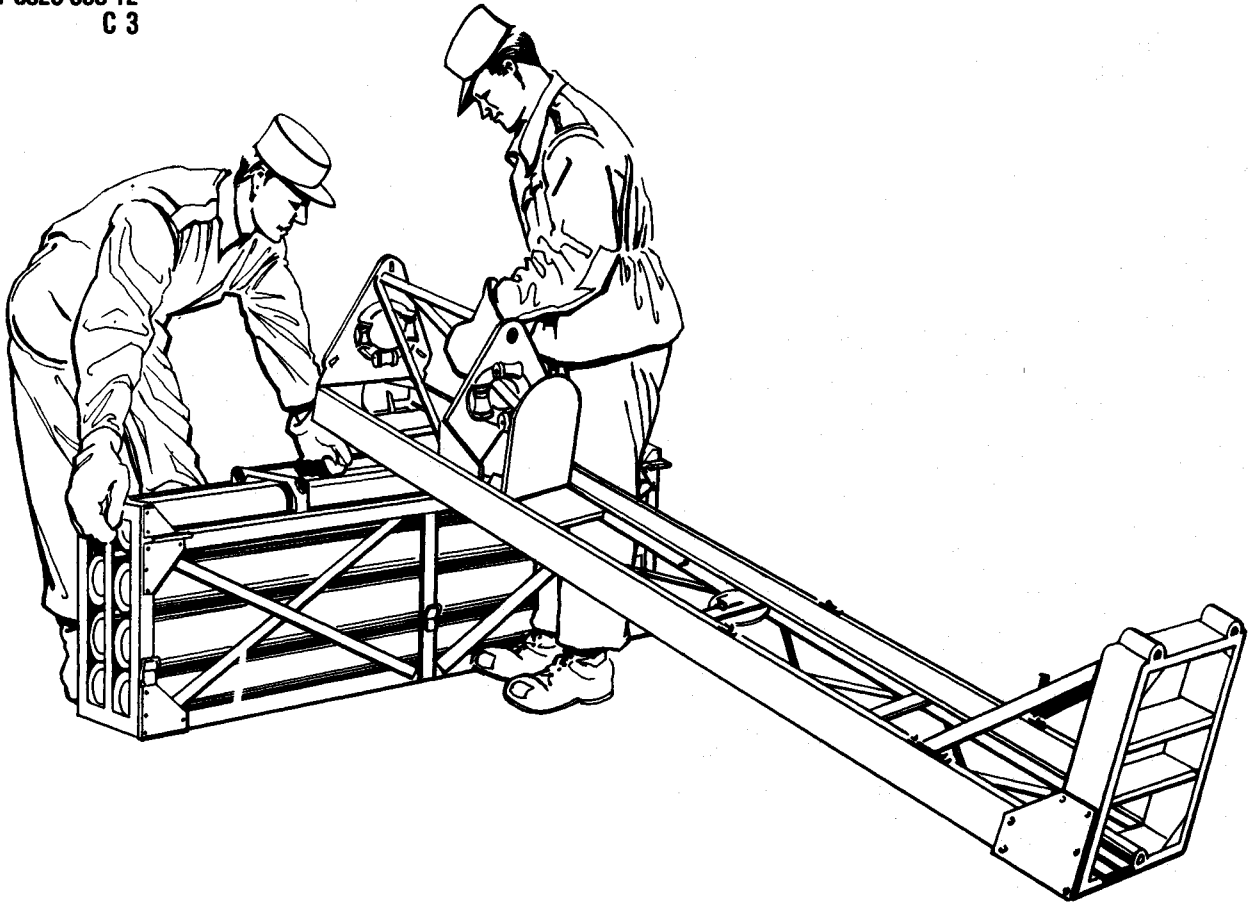

Figure 2-9. Mast section carrier and launcher frame.



EL98F009

| Figure 2-10. Removal of mast section carrier from launcher frame.



EL98FO13

Figure 2-11. Preparation of launcher.

(2) Set an open mast section coupler over the top of the mast section (B, fig. 2-3).

(3) Place the AT-903/G on the end of the mast section. Rotate the AT-903/G until the key in its base seats in the slot in the mast section; tighten the mast section coupler. The mast section is securely clamped if the mast section coupler cannot be manually turned about the mast joint. If the mast section coupler can be turned, replace it with another coupler and again test to ensure a securely clamped joint. If changing coupler fails to produce a secure joint, the lower mast section may be defective and should be replaced.

(4) Proceed to *f* below.

*d. Mounting Two AT-903/G's.* The antenna adapter and the top guy ring assembly (fig. 2-12-4) are required. Also required is a Support, Antenna AB-720/G (para 1-5b) or a Support, Antenna AB-957/GRC (para 1-5c).

(1) Check the polarization and the depression/elevation settings (para 2-3) of the AT-903/G's; adjust as necessary (fig. 2-13).

(2) Set an open mast section coupler over the top of the mast section (B, fig. 2-3).

(3) Set the antenna adapter on the end of the mast section (B, fig. 2-3).

(4) Rotate the antenna adapter until the key engages the slot in the top of the mast section and prevents further rotation.

**NOTE**

Some antenna adapters have an arrow pointing to the key.

(5) Tighten the mast section coupler. The mast section is securely clamped if the mast section coupler cannot be manually turned about the mast joint. If the mast section coupler can be turned, replace it with another coupler and again test to ensure a securely clamped joint. If changing coupler fails to produce secure joint, the lower mast section may be defective and should be replaced.

(6) Slip the top guy ring assembly over the antenna adapter (fig. 2-12-4).

(7) To mount an AB-720/G (fig. 1-2), proceed as follows:

(a) Set the AB-720/G over the antenna adapter, and rotate it until it is seated.

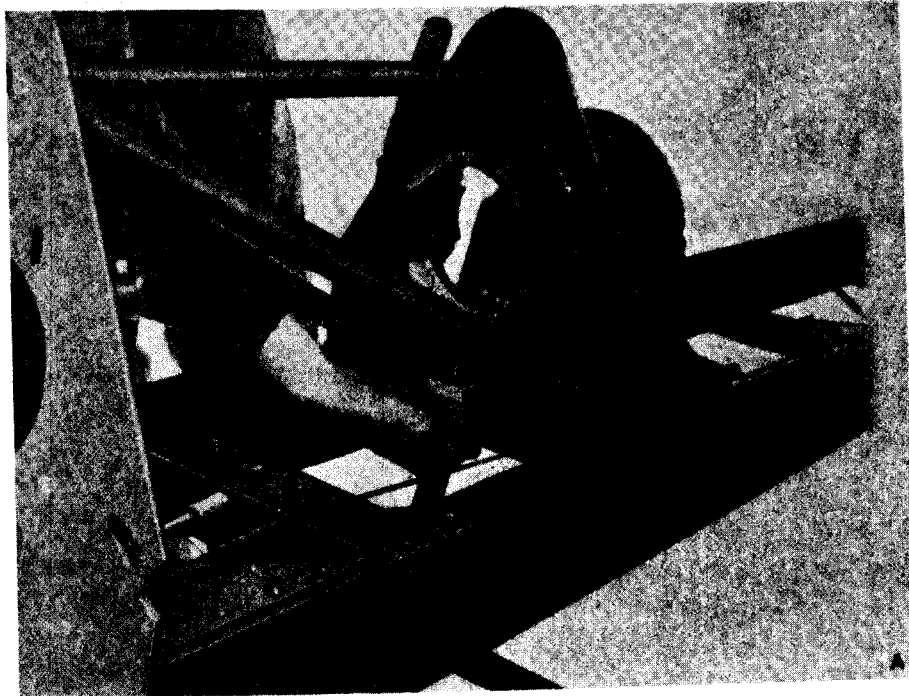

Figure 2-12①. Antenna mounting procedure (part 1 of 4).

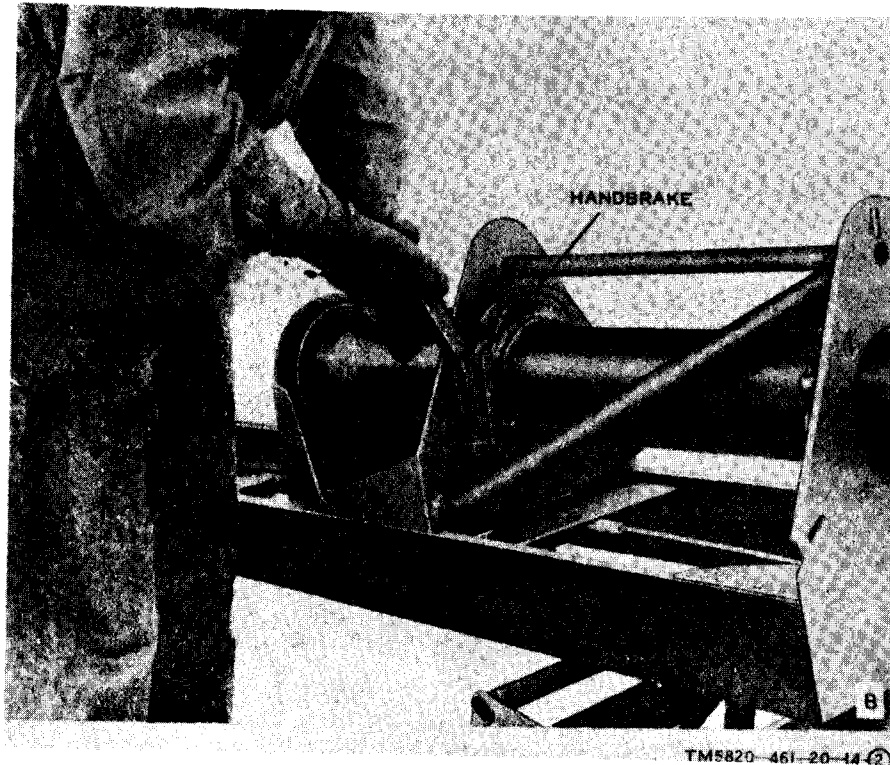
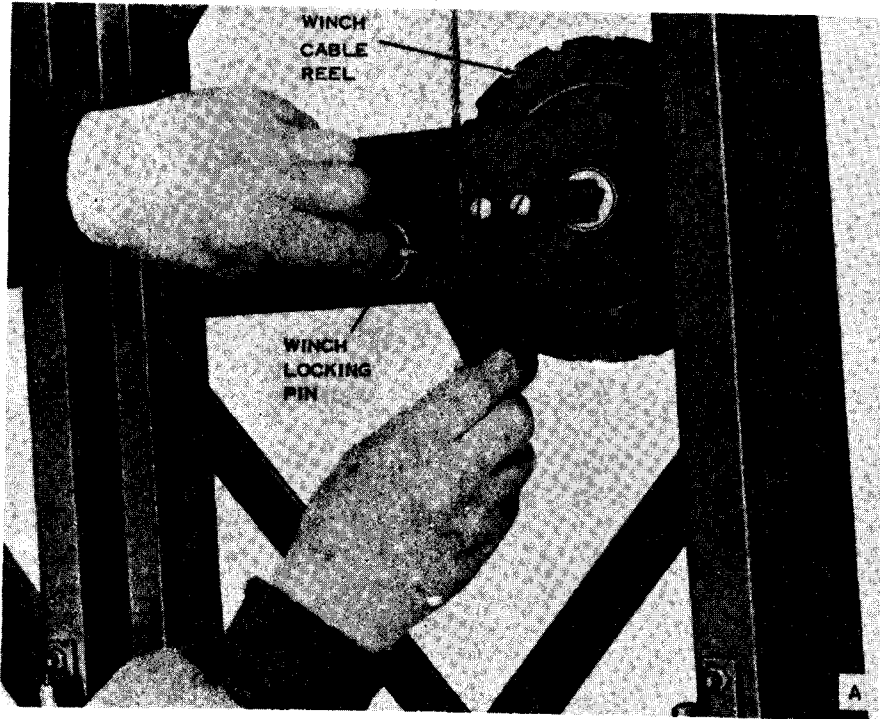
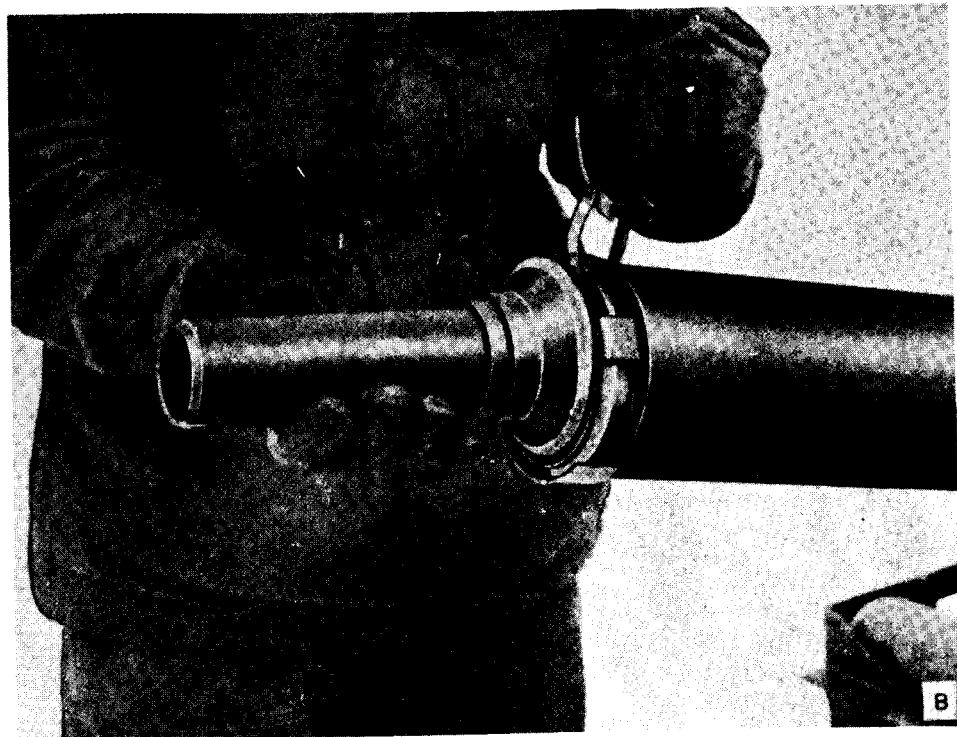

Figure 2-12ⓐ. Antenna mounting procedure (part 2 of 4).



*Figure 2-12*ⓐ. *Antenna mounting procedure (part 3 of 4).*

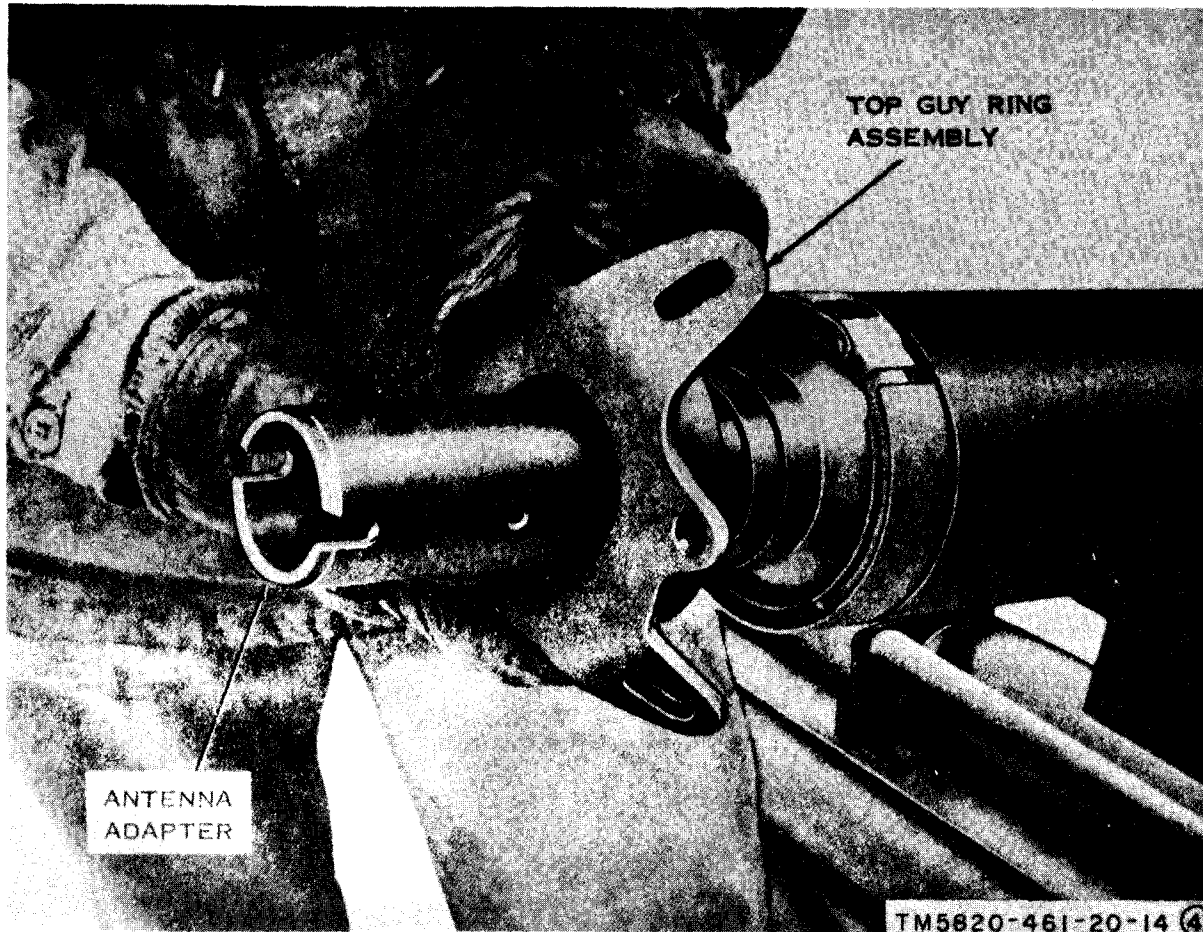

Figure 2-12④. Antenna mounting procedure (part 4 of 4).

- (b) Loosen the antenna clamps on both arms of the AB-720/G (fig. 1-2).
- (c) Set an AT-903/G on one arm of the AB-720/G. Rotate the AT-903/G until its key engages in the slot of the antenna clamp. Tighten the antenna clamp.

*Note.* If it is difficult to insert fully the AT-903/G, remove the paint on the mating surfaces and apply a light coat of grease.

- (d) Set the second AT-903/G on the other arm of the AB-720/G. Rotate the AT-903/G until its key engages the slot of the antenna clamp. Tighten the antenna clamp.

(e) Proceed to f below.

- (8) To mount an AB-957/GRC (fig. 1-3), proceed as follows:

- (a) On the lockpin in the center bar (B, fig. 1-3), press the spring-loaded button under the pull ring (to release the retaining balls on the other end of the pin) and pull the lockpin out.

- (b) Remove the antenna mount from the center bar and press the push-button to reinsert the lockpin.

- (c) Set the AB-957/GRC on the antenna adapter until the lockpin engages the slot in the antenna adapter.



(d) Check to see that the antenna mount on the left antenna holder is secured with its lockpin.

(e) Set an AB-903/G on the left antenna mount. Rotate the AT-903/G until its pin drops into the slot in the antenna mount.

(f) Put silicon grease or equivalent on the right antenna mount to facilitate the rotation of the antenna from the ground.

(g) Set the other AT-903/G on the right antenna mount. Rotate the AT-903/G until its pin drops into the slot in the antenna mount. This antenna is free rotating.

(h) Proceed to f below.

*e. Mounting Antenna Other Than AT-903/G.* Adapt the procedures given in c or d above to mount an antenna other than an AT-903/G. If the antenna does not have a guy ring assembly to which the guy assemblies can be attached, use the top guy ring assembly and antenna adapter provided with the AB-577/GRC.

*f. Attaching Guys to Launcher and Top of Mast.*

(1) *Launcher.* Attach the three launcher guys (coded blue) to the launcher (fig. 2-15). Adjust the length of the two guy assemblies for the *second* and *third* guy anchors (A, third step, fig. 2-6) close to the actual length (36 feet) required after the launcher is erected. Connect the snubber end of these guy assemblies to the second and third guy anchors.

(2) *Top guy assemblies.* When the MK-806/GRC is not used, use the AB-577/GRC top guy assemblies (coded red). When the MK-806/GRC is used, use the MK-806/GRC top guy assemblies (coded orange).

(a) When a single AT-903/G is used, attach the three top guy assemblies to the AT-903/G (fig. 2-15).

(b) When the AB-720/G is used, attach the three top guy assemblies to the top guy ring assembly (fig. 2-12 4 and 1-2). Also attach the guy assemblies to the ends of the AB-720/G (fig. 1-2).

(c) When the AB-957/GRC is used (fig. 2-14), attach guys as instructed in (b) above. Add two more guys (fig. 2-16) so that the movable antenna can be rotated from the ground. If shackles similar to those shown in figure 2-16 are available, mount them as shown. If shackles are not available, insert the snap fastener on the end of a guy through the forward hole in the front brace, bring it around the bottom of the brace, and snap it around the guy. Do the same with another guy, using both smaller holes in the rear brace.

## 2-6. Attaching Antenna Cables

Figures 1-2 and 2-14 show typical cable connections to the antenna. Other cables and adapters may be issued with the radio set; however, in general they are connected as shown in the illustrations.

a. Attach the snap fasteners of the cable grips to the ring in the top guy ring assembly as shown in figure 1-2.

b. To prevent the CG-718B/U (or equivalent) from whipping in the wind, attach the cable to mast with electrical tape.

c. After each cable connection is made, check to make sure that the joint is locked completely, and wrap electrical tape over the joint to keep out water.

d. Set up the cable reel so that the antenna cable unwinds freely as the mast is put together. Tie the antenna cable to the mast every three or four mast sections to prevent the cable from whipping in the wind.

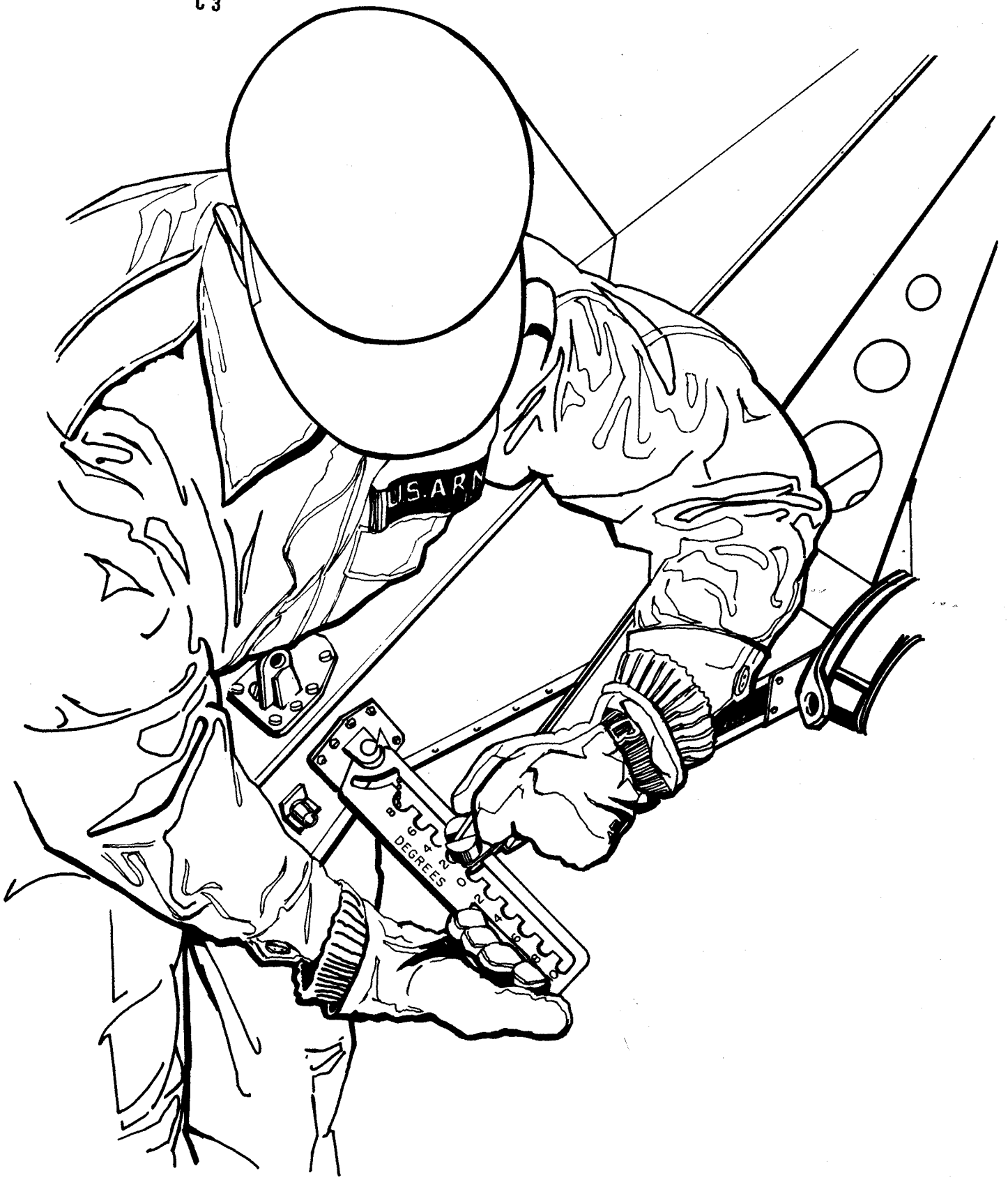

Figure 2-13. Depression/elevation adjustment, AT-903/G.

EL9BF01.

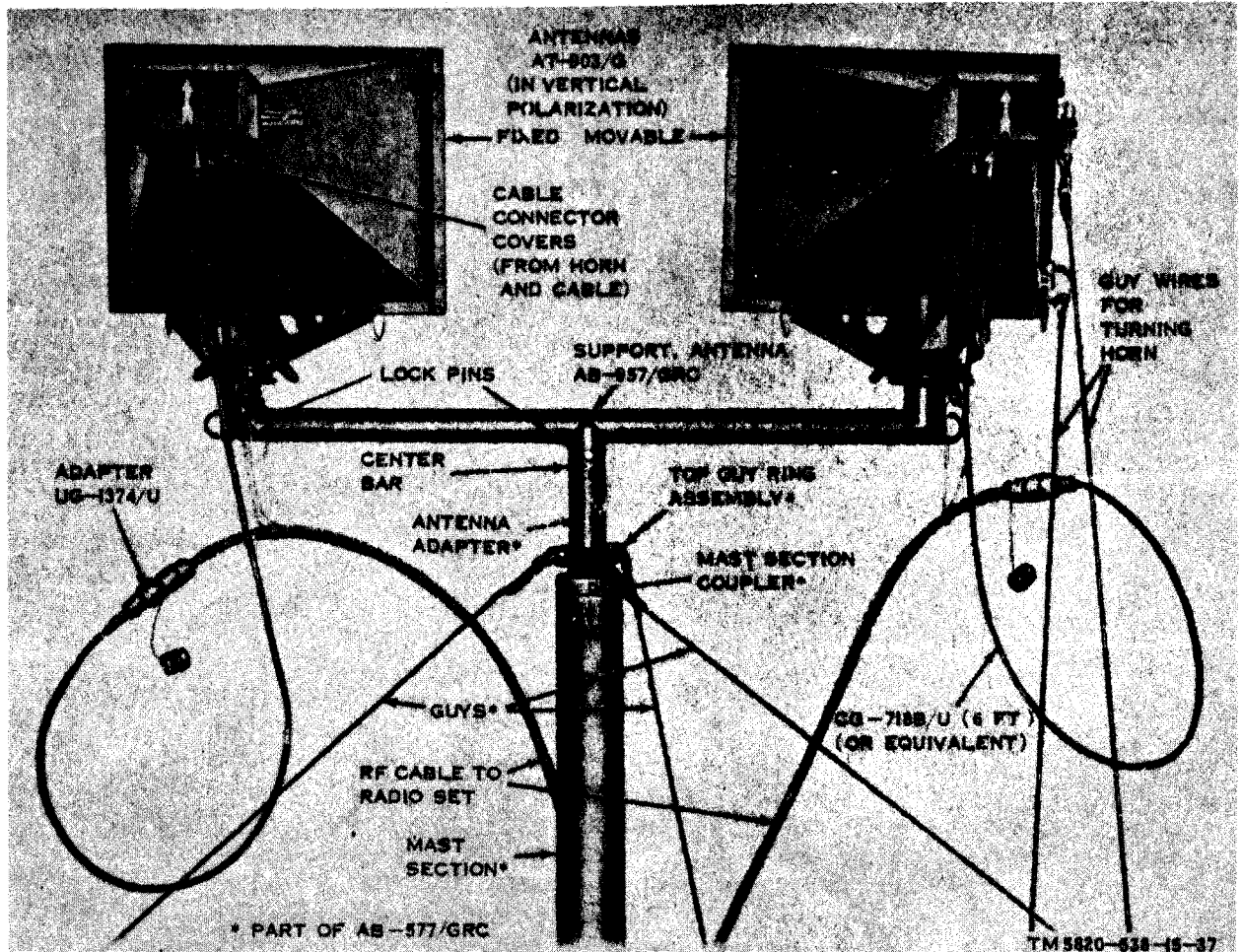

Figure 2-14. Use of Support, Antenna AB-957/GRC.

## 2-7. Erection of Launcher

After the procedures in paragraph 2-6 have been performed, erect and set the launcher in position as given in *a* through *l* below:

*a.* Push a GP-2 into each side of the launcher to operate as a hinge in raising the launcher to vertical position (fig. 2-17⊙). Remove the GP-2 that was used to indicate the center position of the launcher base.

*b.* Drive a GP-2 into the ground on each side of the launcher to prevent the launcher from slipping out of position during erection (fig. 2-17⊙).

*c.* Raise the launcher to vertical position

(fig. 2-17⊙). The launcher will stand unsupported in the vertical position if the ground is level.

*d.* Attach the snubber end of the third guy assembly to its guy anchor (A, third step, fig. 2-6).

*e.* Adjust the launcher guys as follows:

- (1) Check the target level (fig. 2-17⊙) to determine if the launcher is level.
- (2) Unscrew the snubber adjustment to its fully extended position (open) (fig. 2-17⊙).
- (3) Unlock the snubber clamp, and take up the slack in the guy (fig. 2-17⊙). Lock the snubber clamp.



*Figure 2-15. Attaching launcher and top guys.*

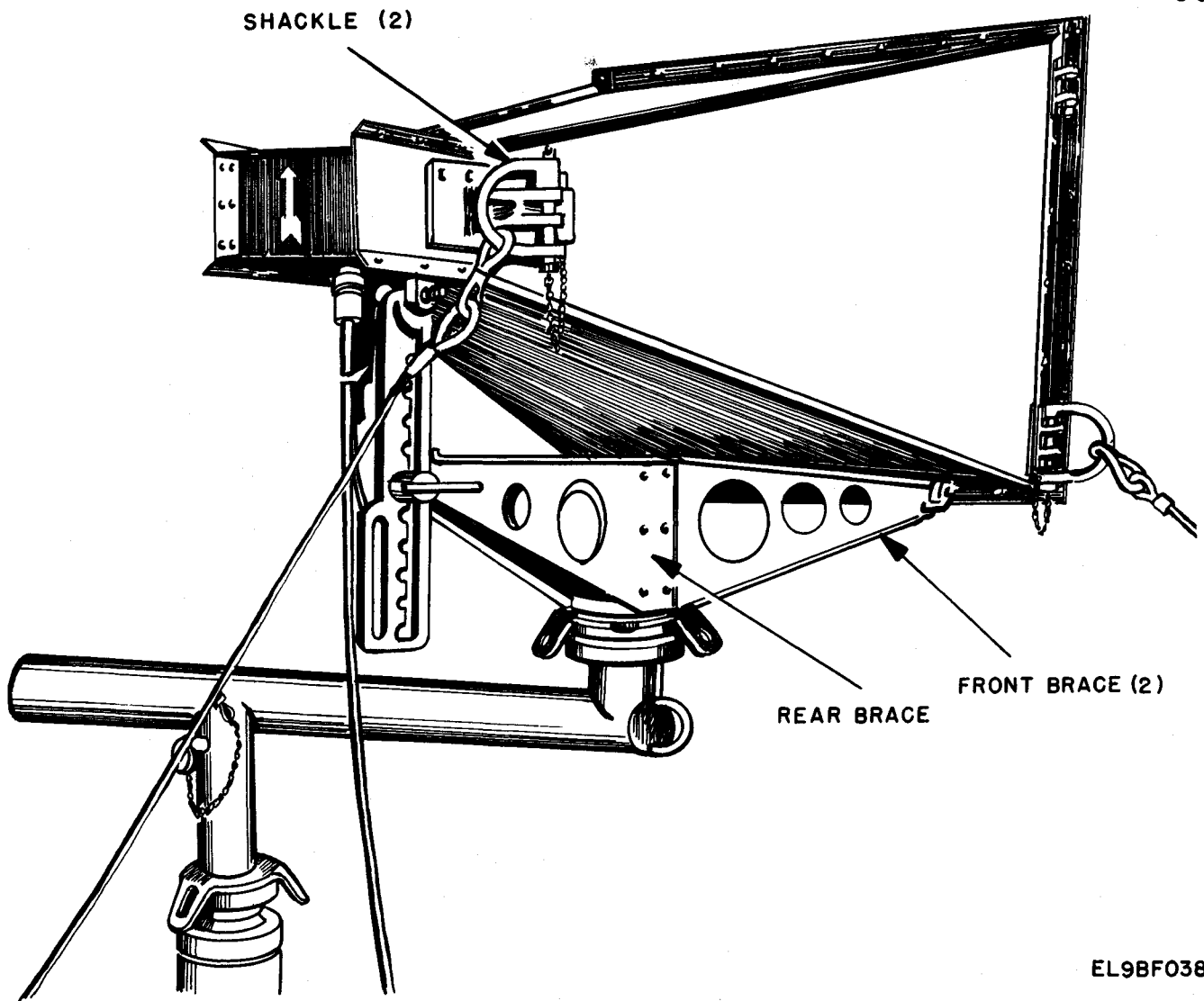

EL9BF038

Figure 2-16. Location of guys for movable antenna.

(4) Take up on each snubber adjustment until the launcher is level.

f. Drive two GP-2 stakes partly into the ground through the front of the launcher base to prevent the launcher from shifting position (fig. 2-17-3).

g. Remove the two GP-2 stakes that were used as a hinge (a above).

h. Install the winch assembly on the launcher frame (fig. 2-17-4). Slide the winch shaft lock (located on the rear of the winch reel supporting frame) (fig. 2-17-5) over the winch shaft to lock the winch assembly in position. Make sure that the elevator cable is threaded over the pulley wheels.

i. Operate the winch to raise the elevator up to the

bottom of the mast section.

j. Drive a third GP-2 into the ground through the rear of the launcher base (fig. 2-17-8).

k. Drive each GP-2 fully into the ground. Check the target level to make sure that the launcher is still level. If necessary, adjust the snubber assemblies to control the tension of the guys.

l. Install the spanner wrench as a foot lever in the launcher base (fig. 2-17-9).

## 2-8. Raising Mast

After the launcher has been erected (para 2-7), install the mast sections, middle guy assemblies, and guys as follows:

### NOTE

Refer to figure 2-18 to determine the locations for the middle guy ring assemblies and number of mast sections required, depending on whether the AB-577/GRC is being used alone or with the MK-806/GRC.

### WARNING:

If men are not available to hold the ends of the guy assemblies during erection of the mast in windy weather, use the following procedures to safeguard personnel and equipment:

1. Attach the *top guy assemblies* to their respective guy anchors (fig. 2-18), and take up the slack in the guys (para 2-7e(2) and (3)).

2. Before each mast section is ready to be raised (a(1) and (6) below), loosen the guys enough to allow the mast section to be raised (a(7) below) and take up the slack in the guys again when the mast section is elevated.

3. Repeat this procedure for the installation of each mast section.

#### a. First Mast Sections.

- (1) Release the handbrake, and operate the winch to raise the first mast section to the upper limit. The elevator stop will determine the upper limit. Lock the handbrake.

### CAUTION

Always lock the handbrake securely before lowering the elevator.

- (2) Operate the winch to lower the elevator to the lowest position.

- (3) Slip an opened mast section coupler over the bottom joint of the first mast section (A, fig. 2-19-1). Do not tighten the mast section coupler.

- (4) Set another mast section in place on the elevator with the UP arrow on top (B, fig. 2-19-1). Make sure that the bottom of the mast section is seated on the elevator platform.

- (5) Step on the spanner wrench which is being used as foot lever, and raise the elevator platform until the mast section meets the bottom of the mast section above it (fig. 2-19-2). Rotate the mast section until its slot seats in the key in the bottom of the upper mast section. The UP arrow points to the slot in the top of the mast section. Lock the mast section coupler. The mast section is secured if the mast section coupler cannot be manually turned about the mast joint. If the mast section coupler cannot be turned, replace it with another coupler and again test to ensure a securely clamped joint. If changing coupler fails to produce a secure joint, the lower mast section may be defective and should be reported on Standard Form 368.

- (6) Raise the elevator platform about 2 inches with the winch until the new mast section is resting on the elevator.

- (7) Release the handbrake, and operate the winch to raise the mast section to the upper limit. Lock the handbrake.

- (8) Repeat the procedures given in (1) through (7) above to install two more mast sections before the middle guy assemblies are installed (b below).

b. *Middle Guy Assemblies.* Refer to figure 2-18 to determine how many mast sections are required for the installation, where the middle guy ring assembly is placed, and which guy assemblies are used. Note that when the MK-806/GRC is used, five mast sections are installed before the middle guys are installed. To install the middle guys, use the following procedures:

- (1) Raise the last mast section approximately halfway, and lock the handbrake.

- (2) Climb up the rear of the launcher, and place the middle guy ring around the *bottom* of the mast section coupler (B, fig. 2-19-2). Align the guy holes of the middle guy ring with the location of the guy stakes; put the pin through the middle guy ring (A, fig. 2-19-3). (The ring should be free to rotate.)

- (3) Connect the top ends of the proper middle guy assemblies to the middle guy ring (B, fig. 2-19-3). Connect the other ends of the guy assemblies.

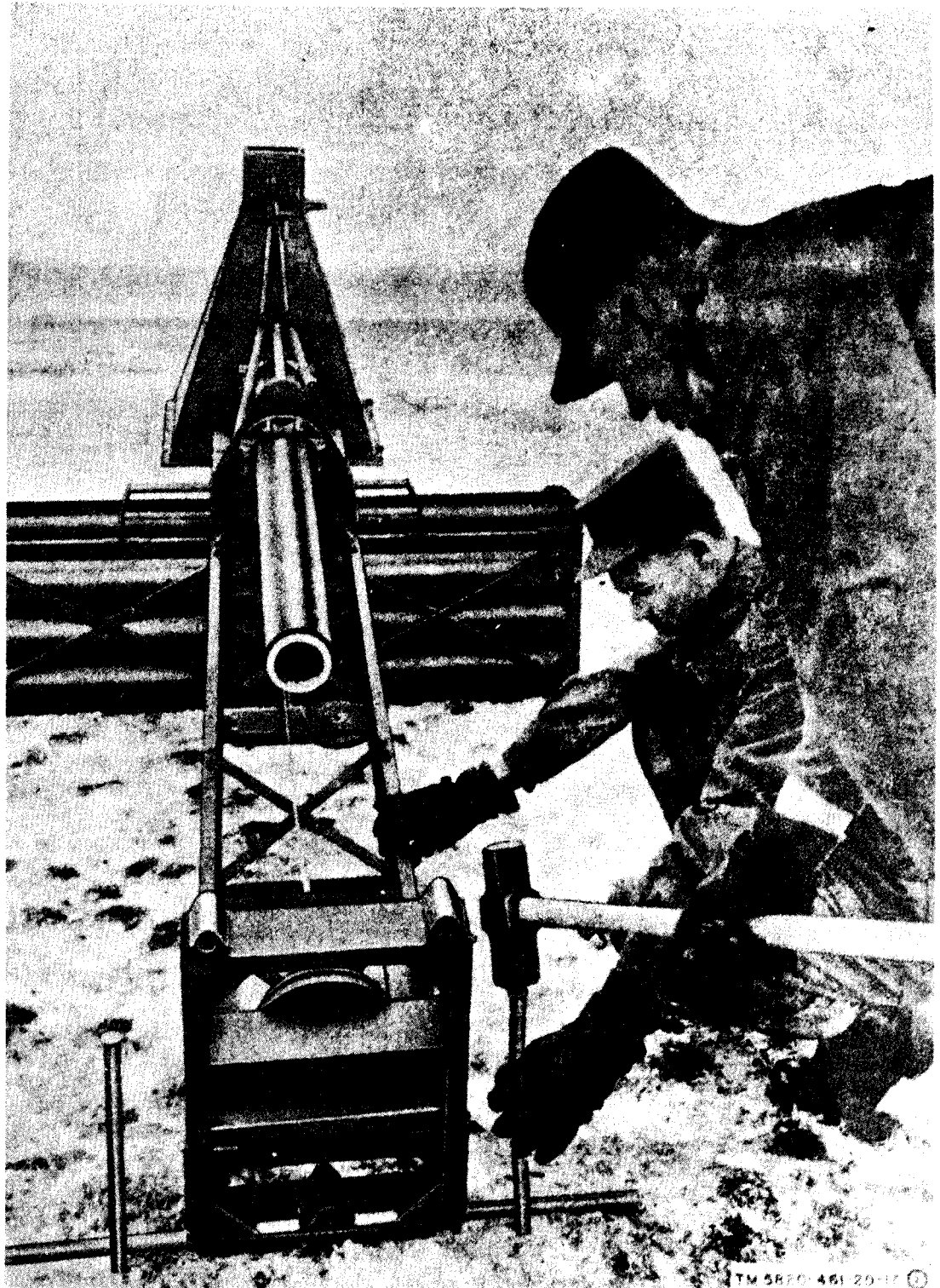

Figure 2-17①. Erection of launcher (part 1 of 9).



*Figure 2-17*Ⓢ. *Erection of launcher (part 2 of 9).*



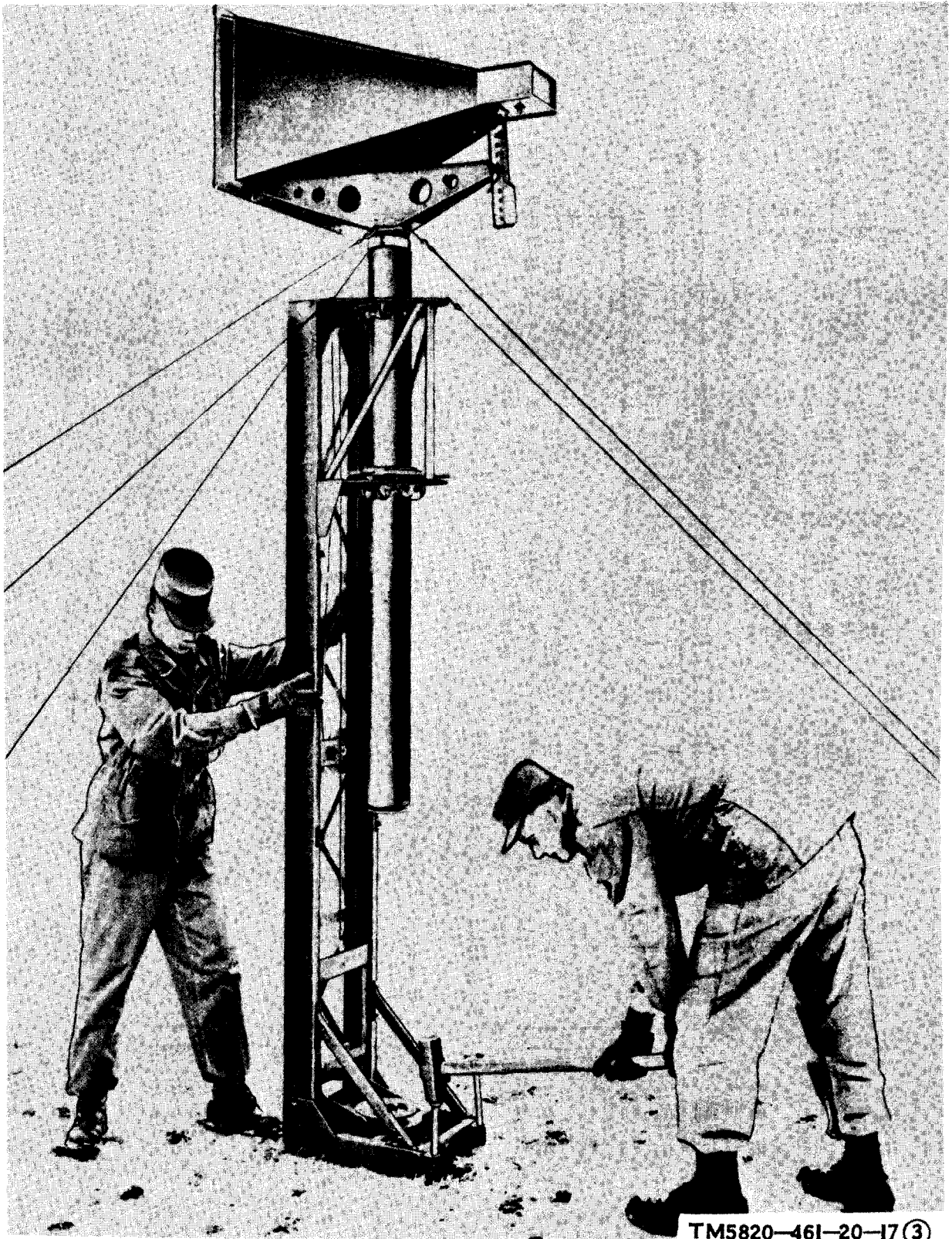
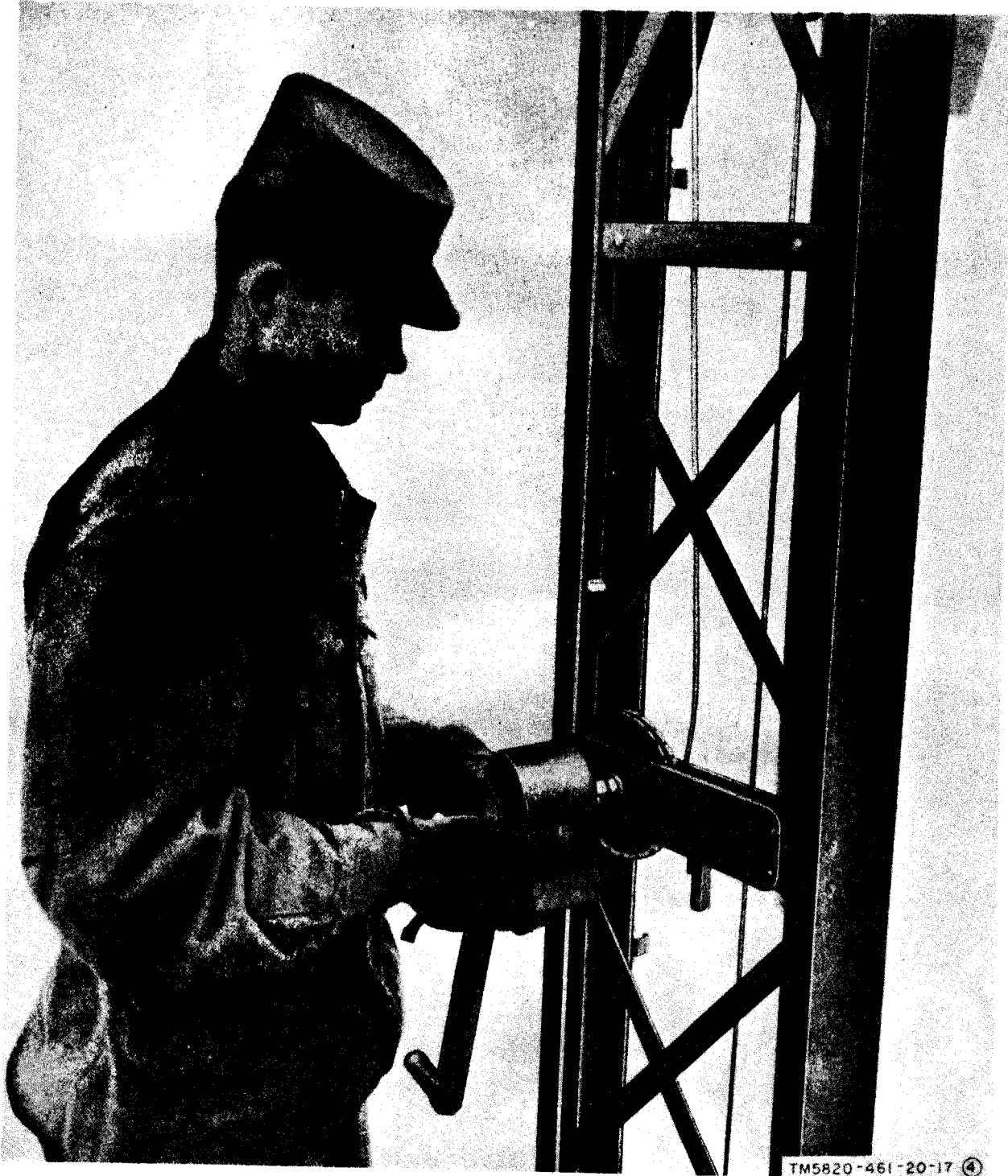

Figure 2-17③. Erection of launcher (part 3 of 9).



*Figure 2-17④. Erection of launcher (part 4 of 9).*

to the associated guy stake. Put tension on the guy assemblies (para 2-7e).

- (4) Release the handbrake, and operate the winch to raise the mast to its upper limit.

*c. Last Mast Sections.* After the middle guy ring has been installed, install the remaining mast sections. Use the procedures given in a(1) through (7) above.

- (1) When the last mast section has been placed on the elevator platform, align

the arrow in the mast platform base bearing with the arrow on the bottom mast section. Rotate the base bearing until its slot engages with the key in the base of the mast section.

- (2) Release the handbrake, and operate the winch to raise the mast to its highest position.

*d. Mast Section Carrier.*

- (1) Remove the spanner wrench from the base of the launcher.

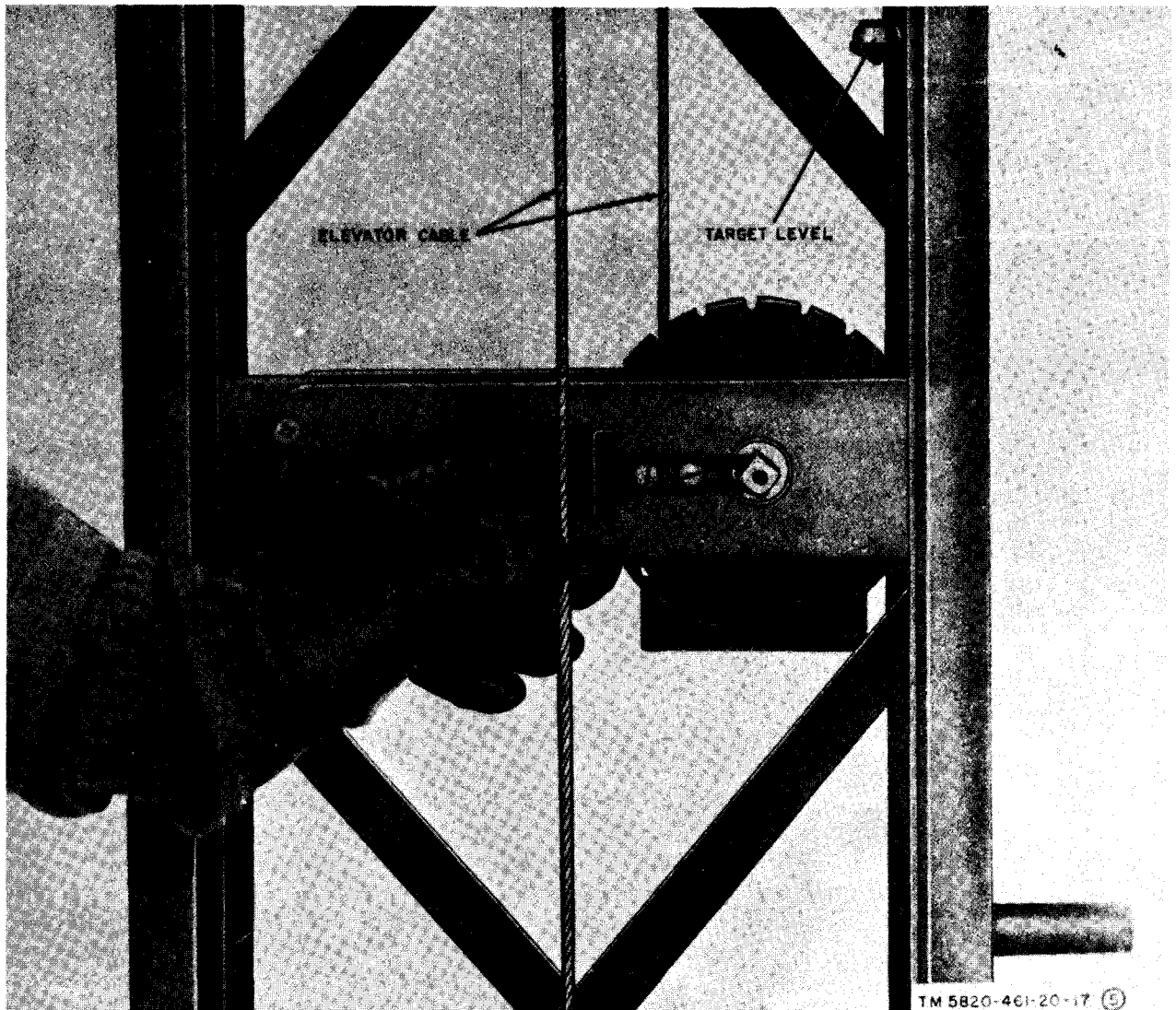

Figure 2-17⑤. Erection of launcher (part 5 of 9).

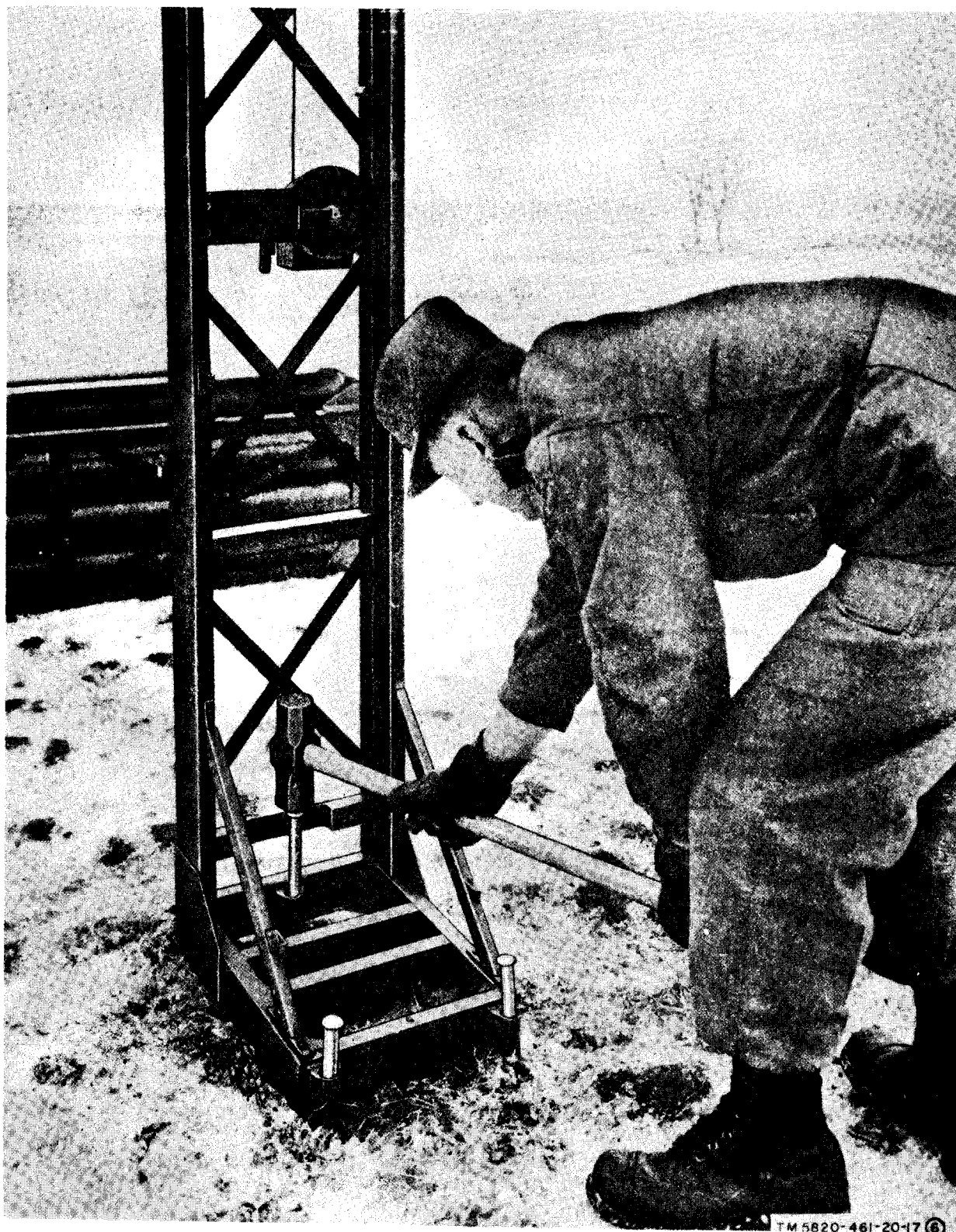

Figure 2-17⑥. Erection of launcher (part 6 of 9).



Figure 2-17⑦. Erection of launcher (part 7 of 9).



TM5620-461-20-17

*Figure 2-17*Ⓢ. *Erection of launcher (part 8 of 9).*



Figure 2-17Ⓣ. Erection of launcher (part 9 of 9)

- (2) Install the mast section carrier of the AB-577/GRC into the launcher to serve as a base with the launcher (A, fig. 2-19Ⓣ). Lock the mast section carrier in position by closing the latches (B, fig. 2-19Ⓣ).
  - (3) Release the handbrake, and operate the winch to lower the mast until its full weight rests on the mast section carrier. There should be no tension in the elevator cable. Lock the handbrake.
- e. Guy Assemblies.*
- (1) Make sure that there is slack in the

top and middle guys.

- (2) Check the level of the launcher with the target level (fig. 2-17Ⓣ).
- (3) Unscrew the snubber adjustment on each top and middle guy to its fully extended position (open) (fig. 2-17Ⓣ).
- (4) Using the snubber clamps (fig. 2-17Ⓣ), adjust the tension of the three middle guys until the lower half of the mast is straight.

*Note.* To aid in vertical alignment of the mast, observe it from a distance and compare it with a known vertical object, such as the corner of a building, another antenna mast, or a *straight* powerline pole.

- (5) Correct any misalignment in the mast by tightening the snubber adjustments.
- (6) Repeat the procedure given in (4) above for the top guys of the AB-577/GRC. If the MK-806/GRC is used, repeat again for the guys connected to its top.
- (7) Recheck the level of the launcher with the target level. Make sure that all guys are taut and secure.
- (8) If the double antennas are being used (figs. 1-2 and 2-14), stake the guys holding the T-bar (fig. 2-18) until they are relocated during radio system lineup.

## 2-9. Antenna Azimuth Adjustment (fig. 2-20)

To point the antenna in the desired direction or to change its direction, proceed as follows:

- a.* Release the handbrake.
- b.* Set the spanner wrench into the holes in the mast base bearing (fig. 2-20).
- c.* Rotate the mast until the antenna faces in the desired direction. (Exact antenna azimuth is achieved during lineup of the radio system.)
- d.* Tighten the handbrake.
- e.* When a movable antenna is used on an AB-957/GRC, orient it during radio system



Figure 2-19①. Raising mast (part 1 of 4).



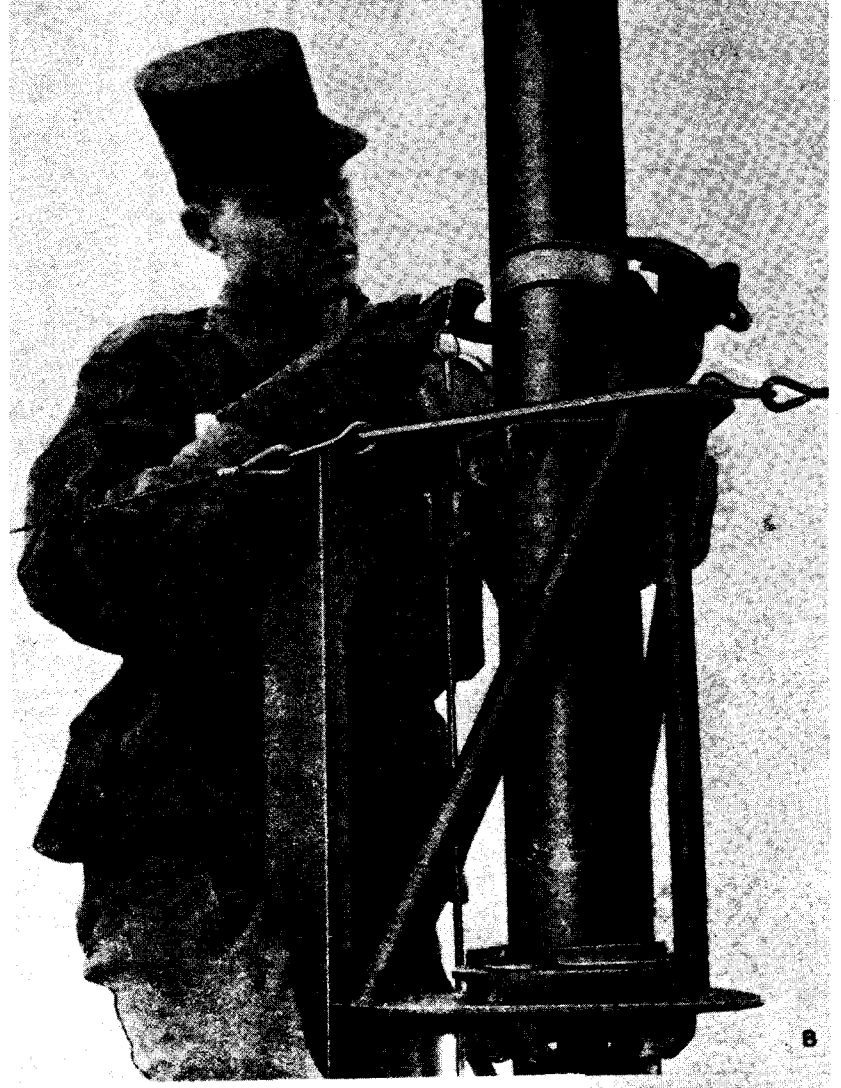

TM5620-461-20-18 ②

Figure 2-19②. Raising mast (part 2 of 4).

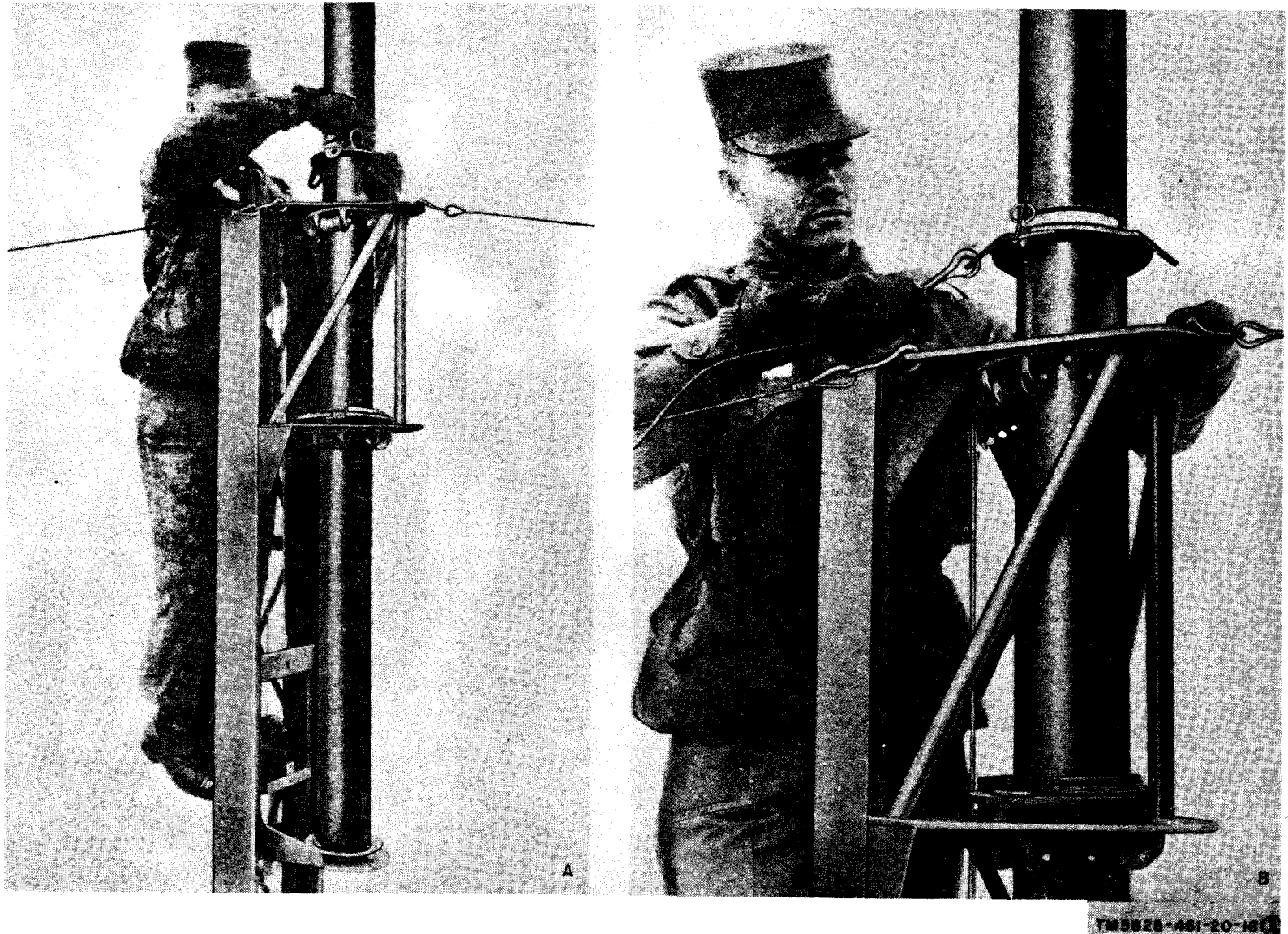
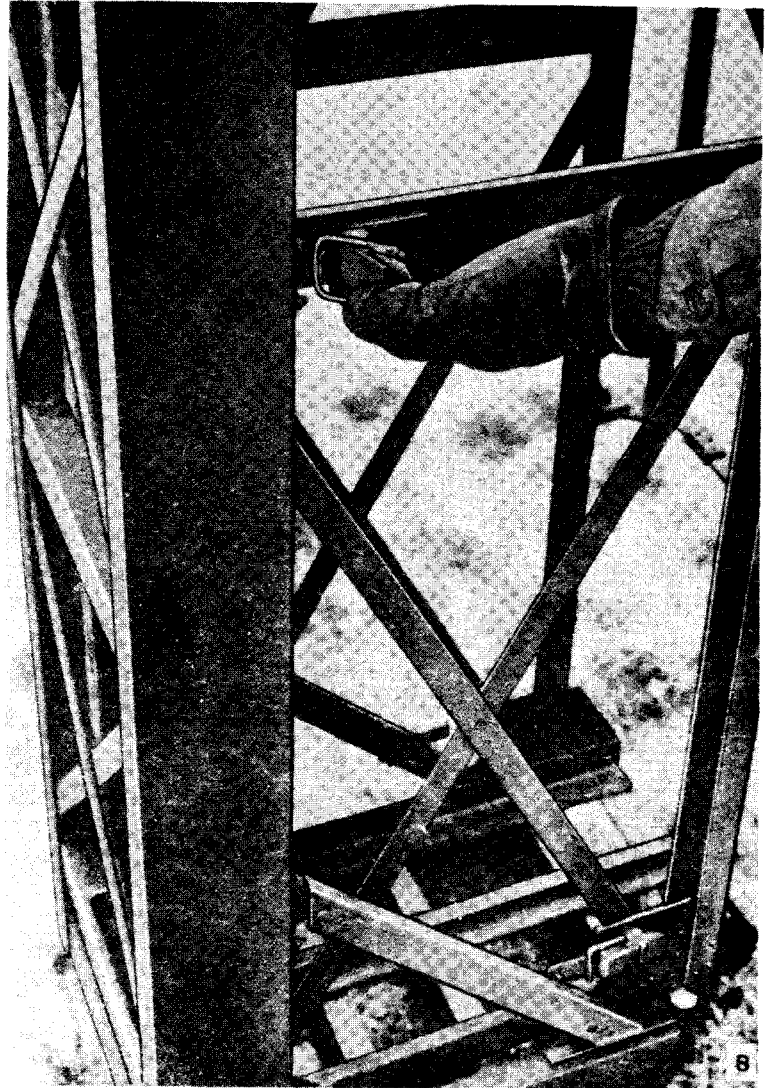
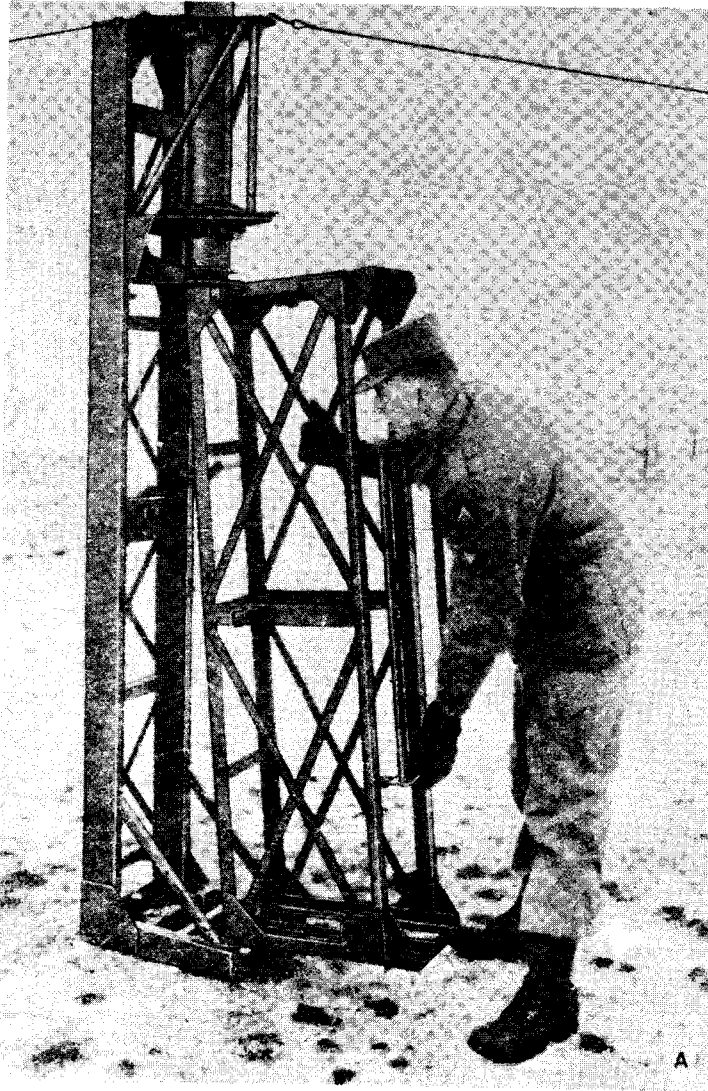

Figure 2-19③. Raising mast (part 3 of 4).



TM5820-461-20-18 ④

Figure 2-19④. Raising mast (part 4 of 4).

lineup by pulling on the guys that were attached to it (para 2-5f(2) (c)). Locate the ground ends of the guys to provide an even pull by each. Refer to figure 2-18. Normally, GP-2's will provide enough anchorage. If

high winds prevail, use applicable guy anchors (para 2-4a).

**2-10. T-Bar Guy Assembly Placement and Adjustment**

After the mast has been raised (para 2-8)

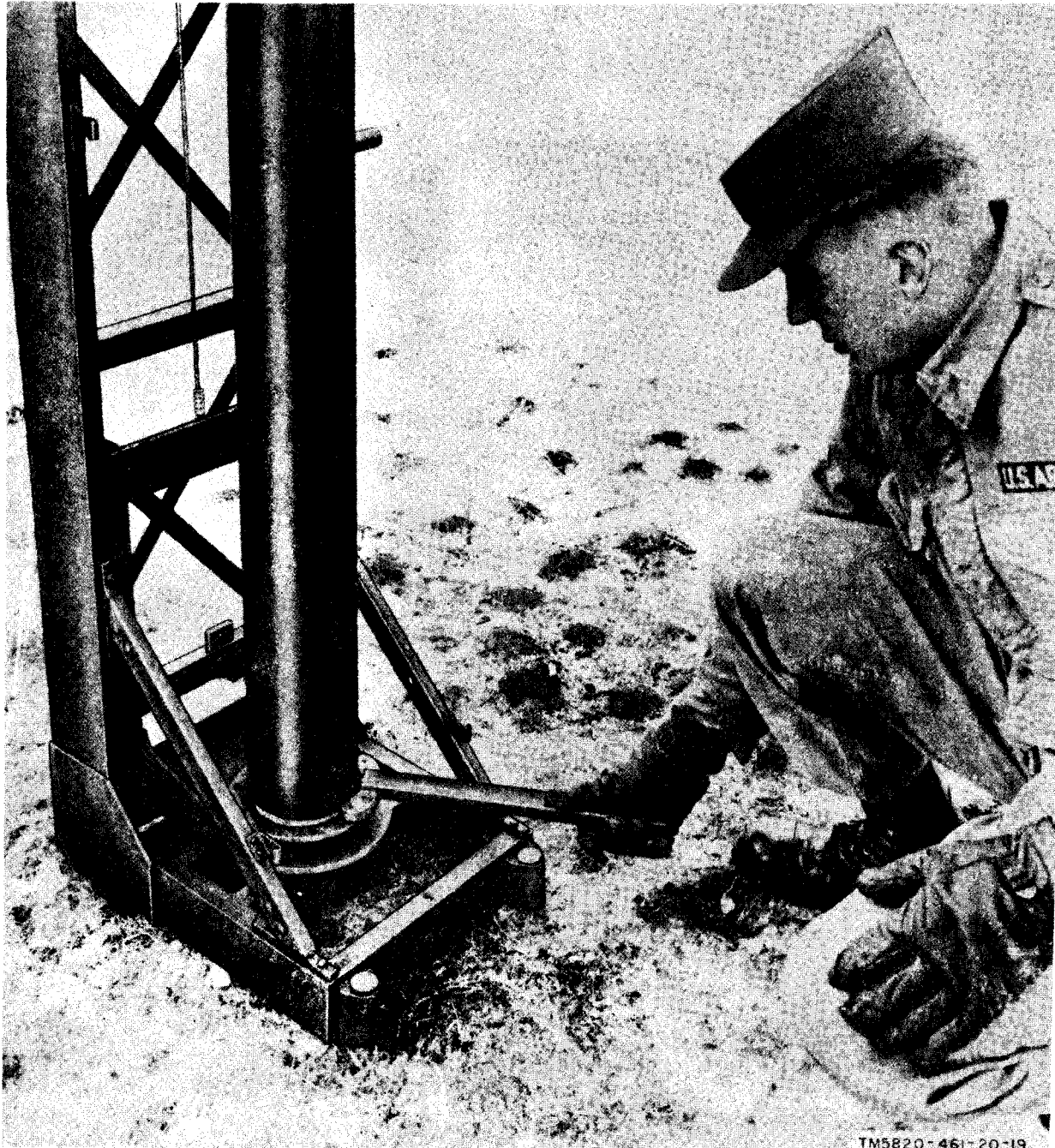

*Figure 2-20. Rotating mast (mast section carrier removed for clarity).*

and the azimuth for the antenna has been established (para 2-9), use the procedures in *a* and *b* below to set the guy anchors for the guy assemblies that are attached to the ends of the T-bar (if used).

*a.* Refer to figure 2-18 for the layout of the guy assemblies with respect to the ends of the AB-720/G. Install the guy anchors; use the procedures given in paragraph 2-4c.

*b.* Connect the guy assemblies to the guy anchors, and adjust them (para 2-8e(5) through (7)).

### 2-11. Antenna Cable Connections

Refer to the technical manual applicable to the radio set for instructions on installation of the antenna cables. The general precautions in *a* through *c* below apply to any installation.

*a.* The antenna cable should be tied to the mast before it is connected to the radio set.

*b.* The antenna cable may be laid on the ground or tied up on poles or other supports.

*c.* The antenna cable should be laid out in such a route that it does not endanger personnel and it is not endangered by vehicles.

### 2-12. Protecting Launcher in Frozen Ground Areas

When the launcher is placed on ground that is frozen, the base is usually severely damaged dur-

ing disassembly when it is pulled and twisted to break it and the stakes out of the frozen ground. To prevent this damage, make an expendable wooden base and put it under the launcher during erection (para 2-7). Then during disassembly (para 4-2c), the launcher is removed from the wooden base even if it has to be broken apart for the purpose. The stakes can be dug out of the frozen ground later. The wooden base can also be used in spongy ground areas; in which case, its purpose is to provide a broader flat base for the launcher.

*a.* During erection, put the wood base on the bottom of the launcher with the hinge stake through the launcher and side stringers of the base (fig. 2-21 and 2-17 1, 2). Drive the stakes into the holes at the corners of the base instead of the launcher during the erection procedures (para 2-7). It is not necessary to drive the stakes far into the ground; they are to hold the wooden base from shifting.

*b.* If the launcher is frozen to the ground during disassembly (para 4-2c), chop away the ice and snow and break the wooden base to free the launcher from the wooden base.

#### CAUTION

Do not pull and jerk the launcher to break it loose from ice and frozen snow. The framework is usually severely damaged by such handling.

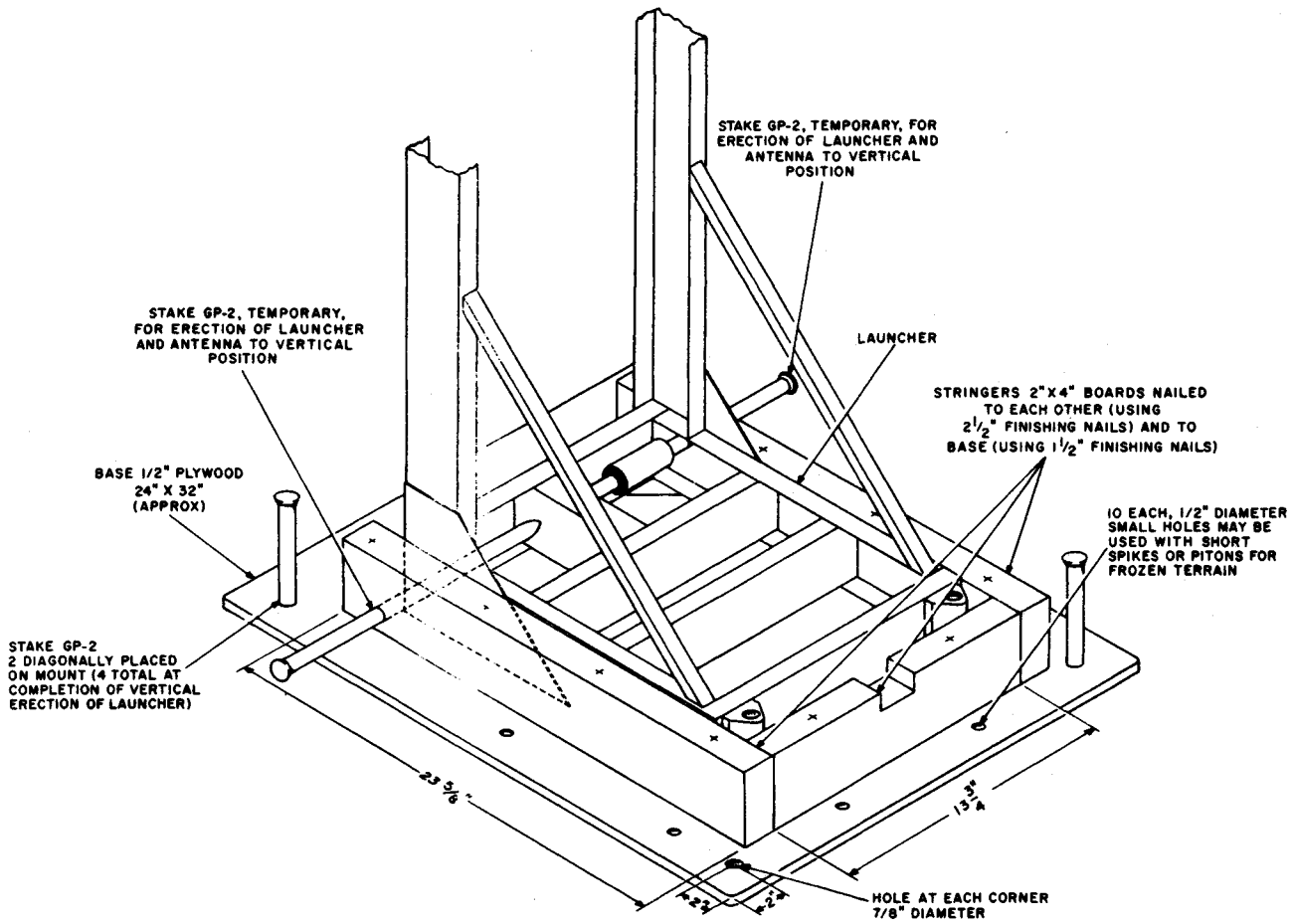

EL5820-538-12-TM-CI-1

Figure 2-21. Fabrication details of wooden base to be used with launcher.

## CHAPTER 3

### MAINTENANCE INSTRUCTIONS

#### Section I. OPERATOR'S MAINTENANCE

##### 3-1. Scope of Operator's Maintenance

Operator's maintenance of the AB-577/GRC and the MK-806/GRC is limited to preventive maintenance. Daily preventive maintenance services are listed in paragraph 3-3. This preventive maintenance checks and services chart outlines functions to be performed daily. These checks and services are to maintain Army electronic equipment in a combat serviceable condition; that is, in good general (physical) condition and in good operating condition. To assist operators in maintaining combat serviceability, the charts indicate what to check, how to check, and what the normal conditions are;

the *References* column lists the illustrations, paragraphs, or manuals that contain detailed repair or replacement procedures. If the defect cannot be remedied by the operator, higher category of maintenance or repair is required. Records and reports of these checks and services must be made in accordance with the requirements set forth in TM 38-750.

##### 3-2. Preventive Checks and Services Periods

Operator's preventive maintenance is required on a daily basis only while the mast is erected. When the equipment is in transit or in limited storage, no operator's maintenance is necessary.

##### 3-3. Operator's Daily Preventive Maintenance Checks and Services Chart

Sequence No.	Item to be inspected	Procedure	References
1	Guy anchors -----	Check to see that all guy anchors are firmly embedded in the earth.	Para 2-4c.
2	Guys -----	Check tension of all guys. The mast should not be loose from too little tension, nor bowed from too much tension on some guys.	Para 2-8e(4) through (7).
3	Launcher -----	Check level of launcher, using the target level.	Fig. 2-17⑥.
4	Handbrake -----	Check to see that the handbrake is firmly locked.	Fig. 2-12②.
5	Launcher base -----	Check to see that the stakes driven through the launcher base are firmly embedded in the ground.	Fig. 2-17⑥.
6	Mast section carrier	Check to see that the latches on the mast section carrier are securely fastened to the launcher.	B, fig. 2-19④.

#### Section II. ORGANIZATIONAL MAINTENANCE

##### 3-4. Scope of Organizational Maintenance

Maintenance by the organizational repairman is limited to replacement of those parts listed in appendix D and to monthly preventive maintenance (para 3-5). Daily preventive

maintenance checks and services constitute a part of the monthly preventive maintenance checks and services and must be performed concurrently. All deficiencies or shortcomings will be reported in accordance with the requirements of TM 38-750.

### 3-5. Organizational Monthly Preventive Maintenance Checks and Services Chart

Sequence No.	Item to be inspected	Procedure	References
1	Completeness .....	Check to see that the equipment is complete.	Appx B.
2	Installation .....	If the mast has been erected, check to see that it is properly installed.	Para 2-4, 2-6 through 2-8.
3	Preservation .....	Check all accessible metal surfaces for corrosion. Remove corrosion, and spot-paint bare spots.	Para 3-6; TB SIG 364.
4	Cleanliness .....	Inspect canvas accessory and anchor-wrap bags for mildew and fungus.	Para 3-6.
5	Publications .....	Check to see that all publications are complete, serviceable, and current.	DA Pam 310-1
6	Modifications .....	Check to determine if new applicable MWO's have been published. All URGENT MWO's must be applied immediately. All NORMAL MWO's must be scheduled.	TM 38-750 and DA Pam 310-1.

### 3-6. Cleaning and Touchup Painting

a. Remove corrosion from metal surfaces with a wire brush or sandpaper. Apply two thin coats of paint. Refer to the applicable cleaning and refinishing practices in TB SIG 364.

**WARNING:**

Adequate ventilation should be provided while using TRICHLOROTRIFLUOROETHANE. Prolonged breathing of vapor should be avoided. The solvent should not be used near heat or open flames, the products of

decomposition are toxic and irritating. Since TRICHLOROTRIFLUOROETHANE dissolves natural oils, prolonged contact with skin should be avoided. When necessary use gloves which the solvent cannot penetrate. If the solvent is taken internally, consult a physician.

b. Remove mildew or fungus from canvas items with a stiff brush. If necessary, use a cloth dampened with TRICHLOROTRIFLUOROETHANE (NSN 6810-00-292-9625).



## CHAPTER 4

### DISASSEMBLY, SHIPMENT, AND LIMITED STORAGE

#### 4-1. General

The mast must be disassembled when it is necessary to adjust the antenna depression/elevation angle, or when it is necessary to dismantle the system. Refer to paragraph 4-2 for disassembly procedures.

#### 4-2. Mast Disassembly

##### a. Antenna Cables.

- (1) Disconnect the antenna cables from the radio set; remove the adapter connectors from the antenna cables, and store them.
- (2) Attach the antenna cable to its reel, and wind it onto the reel as far as it will go. Clean the cable with a dry cloth while it is being wound. As the mast is being lowered (*b* below), continue to wind and clean the cable.

##### b. Lowering Mast.

**Warning:** If personnel are not available to hold the ends of the guys in windy weather, use the following procedures to safeguard the personnel and equipment:

1. Leave the guys connected to their respective guy anchors until they are disconnected from the mast.
2. Just before each mast section is ready to be lowered ((5) below), loosen the snubber clamp on each guy. Lower the mast section on the launcher. Pull the guys taut, and tighten the snubber clamps again.
  - (1) Release the mast section coupler tool (secured to the angle bracket under the top plate of the launcher frame (fig. 4-1)) by removing the locking pin.
  - (2) Release the handbrake, and operate the winch to raise the mast sections

to the upper limit. Lock the handbrake.

- (3) Loosen the six latches holding the mast-section carrier to the launcher (B, fig. 2-19④), and remove the mast section carrier.
- (4) Place the mast section carrier nearby so that the mast sections can be placed into it after their removal.
- (5) Release the handbrake, and operate the winch to lower the mast until the bottom of the elevator is about 5 inches from the bottom of the launcher. Lock the handbrake.
- (6) Unlock the mast section coupler with the mast section coupler tool (fig. 4-2), and remove the mast section coupler.
- (7) Operate the winch to lower the elevator to the base of the launcher.
- (8) Remove the mast section, clean it, and place it in the mast section carrier.
- (9) Operate the winch to raise the elevator to the bottom of the next mast section.
- (10) Repeat the procedures in (2) through (9) above to remove the remaining mast sections. Use the procedures in (11) below to remove the middle guy ring assemblies.
- (11) To remove the middle guy assemblies, lower the mast section on which the middle guy assembly is attached half-way into the launcher, and lock the handbrake. Climb up the rear of the launcher; disconnect the middle guys, and remove the middle guy ring assembly (fig. 2-19⑤).

- (12) Lower the first mast section so that the antenna is approximately 12 inches from the top of the launcher. Lock the handbrake.

*c. Lowering Launcher.*

- (1) Climb up the rear of the launcher, and disconnect the antenna cables.
- (2) Remove the cable grip of the long antenna cable, and reel in the cable on its reel. Remove the cable adapter, and store it in its assigned place in the radio equipment.
- (3) Remove the top guy assemblies from the mast and from the launcher. Remove the other ends of the guy assemblies from the guy anchors.
- (4) Wind up each guy on its snubber assembly, cleaning it in the process; hold the guy coiled up on the snubber assembly with the chain attached to the snubber assembly.
- (5) Rock the launcher slightly to loosen the GP-2 stakes, and pull the stakes out of the ground.
- (6) Move the mast section carrier to a position that will provide a base on which to rest the top of the launcher after it is lowered.
- (7) Install a GP-2 stake into each side of the launcher base to act as a hinge pin. Drive two GP-2 stakes approximately 5 inches into the ground (fig. 2-17ⓐ).
- (8) Lower the launcher until it rests on the mast section carrier (B, fig. 2-12ⓐ).

*d. Antenna and First Mast Section Removal.*

- (1) *Single AT-903/G.* Loosen the mast section coupler with the mast section coupler tool. Remove the AT-903/G and mast section coupler.
- (2) *AB-720/GRC or AB-957/GRC.*
  - (a) Unscrew the antenna clamps, and remove each AT-903/G.
  - (b) Remove the T-bar from the top of the mast.

- (c) On the AB-720/GRC, loosen the mast section coupler with the mast coupler tool; remove the mast section coupler and antenna adapter.

(3) *First mast section.*

- (a) Release the handbrake, and remove the first mast section from the launcher.
- (b) Operate the winch to raise the elevator platform to the upper limit. Insert the locking pin in the rear of the elevator platform. Insert the locking pin in the handbrake (B, fig. 2-12ⓐ).
- (c) Position the mast section coupler tool over the angle bracket at the top of the launcher, and keep it in place with the locking pin (fig. 4-1).

*e. Disassembly of Launcher.*

- (1) Remove the GP-2 stakes that were used as hinges from the bottom of the launcher.
- (2) Pull back the winch shaft latch (A, fig. 2-17ⓐ), and remove the winch (fig. 2-17ⓐ).
- (3) Set the mast section carrier in the launcher, and lock the six catches (fig. 2-9).

*f. Removal of Guy Anchors.*

- (1) To remove a screw-type anchor, insert the digging bar through the anchor eye and use it for leverage to unscrew the anchor from the earth (fig. 2-7).
- (2) To remove Stake GP-112/U, loosen the stake by tapping the eyelet with the hammer. Pull the anchor from the earth.
- (3) Clean each anchor.

**4-3. Packing for Shipment or Limited Storage**

*a.* Pack all accessories in their proper accessory bags or cases (figs. 1-4 and 1-5).

*b.* If the original wooden containers are available, insert the mast units in their boxes or crates (figs. 2-1 through 2-3). Fasten the covers with nails or staples.

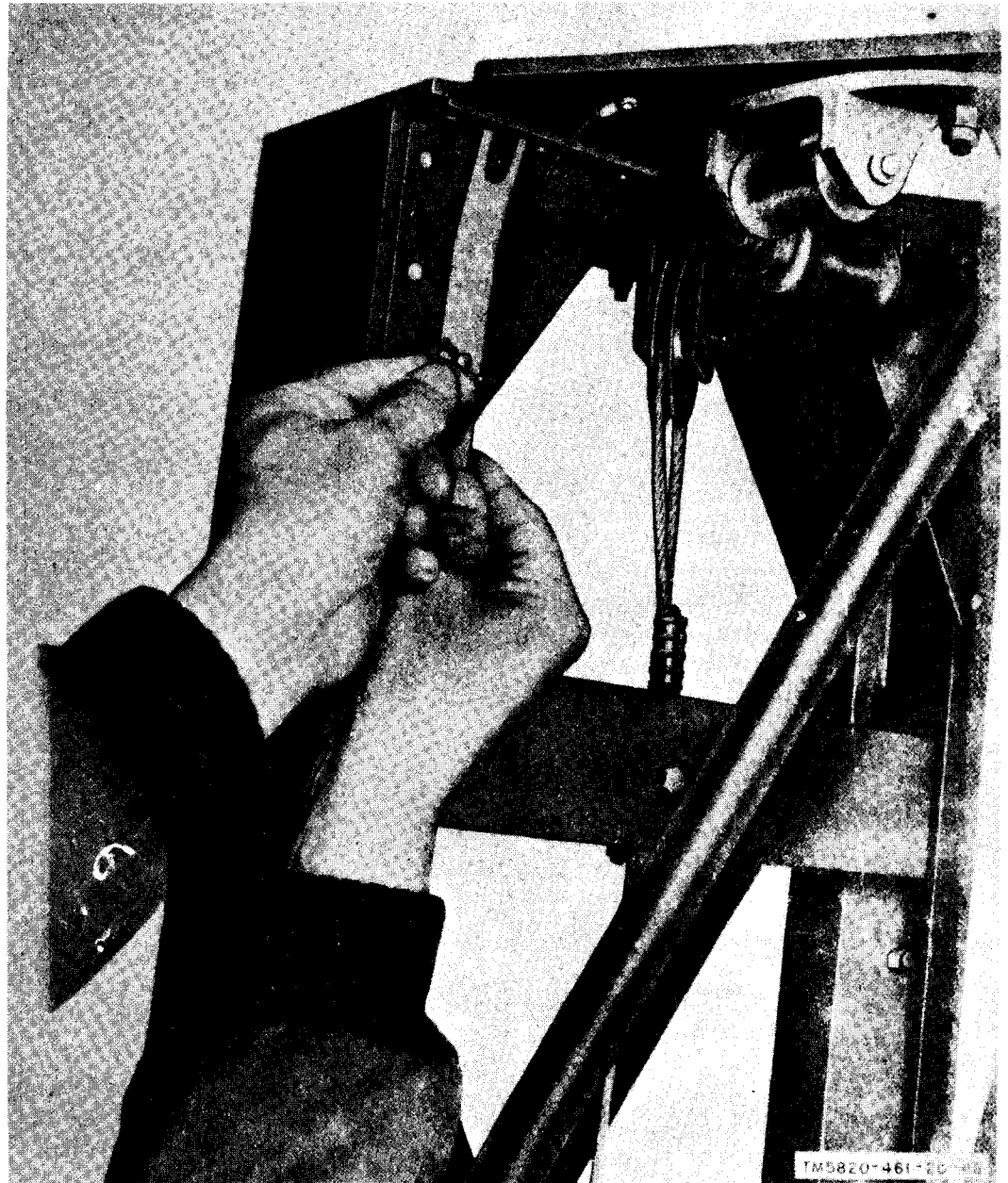

*Figure 4-1. Releasing mast section coupler tool.*

c. If no original containers are available, construct those required in accordance with the dimensions given in the chart in paragraph 2-1a. The materials required, in addition to the wooden crate shown in figure 2-3, follow:

(1) One wooden block,  $14\frac{1}{8}$  by  $4\frac{3}{8}$  by  $1\frac{13}{16}$  inches.

(2) One wooden block,  $14\frac{1}{8}$  by  $2\frac{3}{8}$  by  $1\frac{13}{16}$  inches.

(3) One wooden block,  $16\frac{9}{16}$  by  $2\frac{3}{4}$  by  $1\frac{13}{16}$  inches.

(4) Corrugated padding,  $62\frac{3}{4}$  inches by  $1\frac{3}{4}$  inches by  $\frac{5}{32}$  inch.

(5) Strapping metal, 138 inches by  $\frac{1}{2}$  inch.

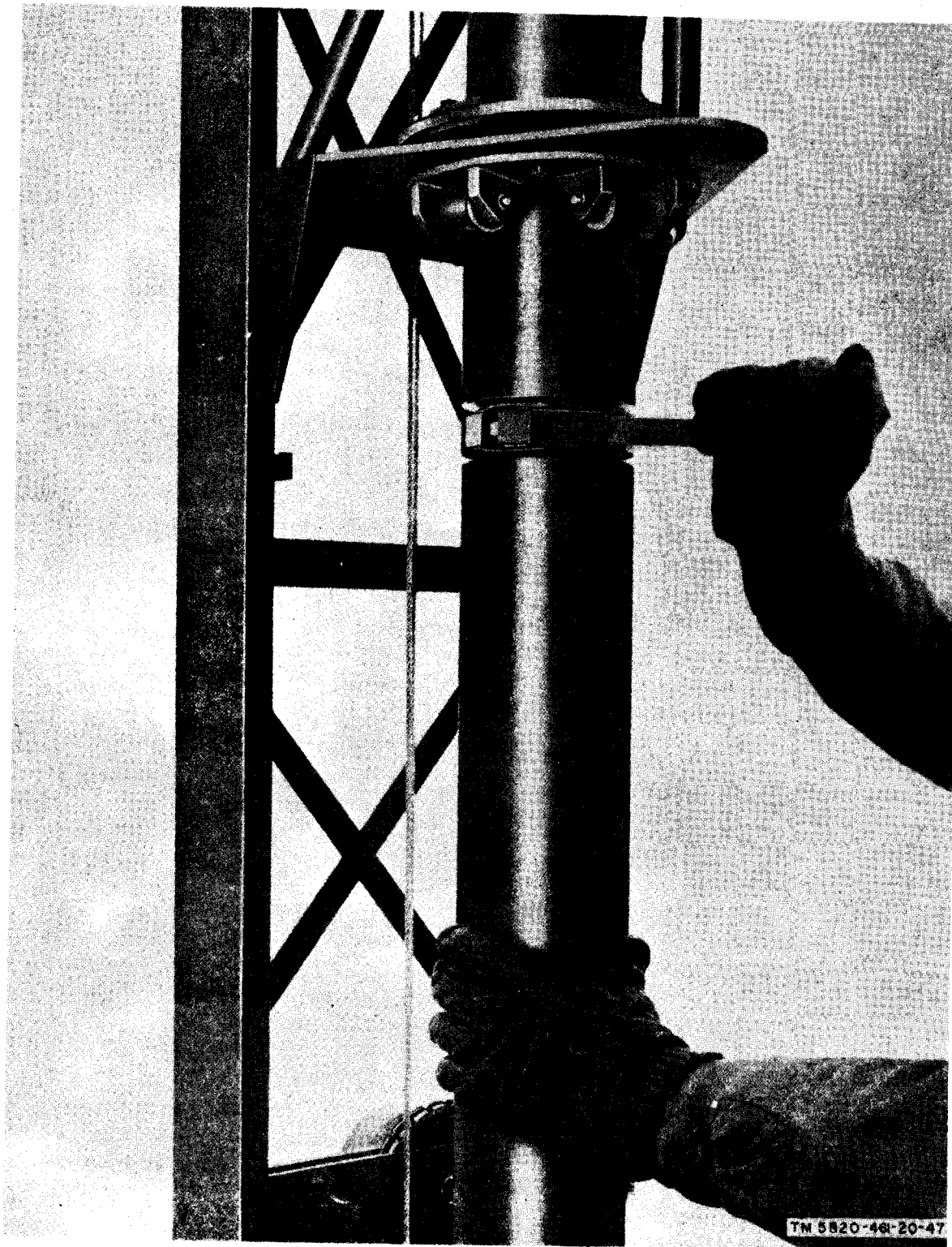

*Figure 4-2. Unlocking mast section coupler.*

## CHAPTER 5

### DEMOLITION OF MATERIEL TO PREVENT ENEMY USE

---

#### 5-1. Authority for Demolition

Demolition of the equipment will be accomplished only upon the order of the commander. The destruction procedures outlined in paragraph 5-2 will be used to prevent further use of the equipment.

#### 5-2. Methods of Destruction

The construction of the equipment is such that destruction methods are limited to distorting the mast sections, their carrier, and the launcher and cutting the guys into pieces.

*a. Bend.* Use a heavy sledge hammer to bend the mast sections, the launcher, and the mast section carrier. Flatten the mast sections as much as possible in the time available. Also bend the guy snubbers.

*b. Cut.* Use an axe or handaxe to cut the guys into as many pieces as possible in the time available.

*c. Dispose.* Bury or scatter the destroyed parts in slit trenches or foxholes, or throw them into streams.



**APPENDIX A  
REFERENCES**

Following is a list of applicable references that should be available to the operator and organizational maintenance personnel of the AB-577/GRC and the MK-806/GRC:

- |  |  |
|--|--|
| <p>DA Pam 310-1<br/> 38-100<br/> SIG 291</p>                         | <p>Consolidated Index of Army Publications and Blank Forms.<br/>Preservation, Packaging and Packing Materials, Supplies, and Equipment Used by the Army.<br/>Safety Measures To Be Observed When Installing and Using Whip Antennas, Field Type Masts, Towers, Antennas, and Metal Poles That Are Used With Communication, Radar, and Direction Finder Equipment.</p>  |
| <p>TB SIG 364<br/>TM 9-213<br/>TM 11-486-6<br/>TM 11-5820-287-12</p> | <p>Field Instructions for Painting and Preserving Electronics Command Equipment.<br/>Painting Instructions for Field Use.<br/>Electrical Communications Systems Engineering: Radio.<br/>Operator's and Organizational Maintenance Manual:<br/>Radio Sets AN/TRC-24 (NSN 5820-00-503-1133), AN/GRC-75 (5820-00-581-2104), AN/GRC-78 (5820-00-581-2105), AN/GRC-81 (5820-00-578-5451) and AN/GRC-81A (5820-00-578-5451); Radio Terminal Sets AN/TRC-35 (5820-00-503-2578), AN/GRC-76 (5820-00-557-6260), AN/GRC-79 (5820-00-693-9796), and AN/GRC-82 (5820-00-578-5413); Radio Relay Set AN/TRC-36 (5820-00-569-0031); Radio Repeater Sets AN/GRC-77 (5820-00-557-6259), AN/GRC-80 (5820-00-561-6680) and AN/GRC-83 (5820-00-578-5452); and Radio Set Groups AN/TRA-25 (5820-00-776-5406), AN/TRA-25A (5820-00-856-9911) and OA-3668A/TRC-24 (5820-00-3214).</p> |
| <p>TM 11-5820-287-20P</p>  | <p>Organizational Maintenance Repair Parts and Special Tools List: Radio Sets AN/TRC-24, AN/GRC-75, AN/GRC-78, AN/GRC-81, and AN/GRC-81A; Radio Terminal Sets AN/TRC-35, AN/GRC-76, AN/GRC-79 and AN/GRC-82; Radio Relay Set AN/TRC-36; Radio Repeater Sets AN/GRC-77, AN/GRC-80 and AN/GRC-83 and Radio Set Group AN/TRA-25.</p>  |
| <p>TM 11-5820-461-12</p>   | <p>Operator and Organizational Maintenance Manual: Radio Sets AN/GRC-50(V)1 (NSN 5820-00-892-3851), AN/GRC-50(V)2 (5820-00-892-3852), AN/GRC-50(V)3 (5820-00-892-3853), AN/GRC-50(V)4 (5820-00-892-3854), AN/GRC-50(V)5 (5820-00-892-3855), AN/GRC-50A(V)1 (5820-00-933-6193), AN/GRC-50A(V)2 (5820-00-933-6192), AN/GRC-50A(V)3 (5820-00-933-6191) AN/GRC-50A(V)4 (5820-00-933-6190), AN/GRC-50A(V)5 (5820-00-933-6189), AN/GRC-50A(V)6 (5820-00-936-5480), AN/GRC-50A(V)7 (5820-00-936-5481), AN/GRC-50A(V)8 (5820-00-935-0089), AN/GRC-50A(V)9 (5820-00-878-8635), AN/GRC-50(V)10 (5820-00-878-8634), AN/GRC-50A(V)11 (5820-00-136-4966).</p>   |
| <p>TM 11-5820-538-20P</p>  | <p>Organizational Maintenance Repair Parts and Special Tools List for Mast AB-577/GRC (NSN 5820-00-892-3862) and Extension Kit, Mast MK-806/GRC (5985-00-691-2344)</p>   |
| <p>TM 38-750</p>   | <p>The Army Maintenance Management Systems (TAMMS).</p>  |





## APPENDIX B MAINTENANCE ALLOCATION

### Section I. INTRODUCTION

#### B-1. General

This appendix provides a summary of the maintenance operations for Mast, AB-577/GRC and Extension Kit, Mast MK-806/GRC. It authorizes categories of maintenance for specific maintenance functions on repairable items and components and the tools and equipment required to perform each function. This appendix may be used as an aid in planning maintenance operations.

#### B-2. Maintenance Function

Maintenance functions will be limited to and defined as follows:

*a. Inspect.* To determine the serviceability of an item by comparing its physical, mechanical, and/or electrical characteristics with established standards through examination.

*b. Test.* To verify serviceability and to detect incipient failure by measuring the mechanical or electrical characteristics of an item and comparing those characteristics with prescribed standards.

*c. Service.* Operations required periodically to keep an item in proper operating condition; i.e., to clean (decontaminate), to preserve, to drain, to paint, or to replenish fuel, lubricants, hydraulic fluids, or compressed air supplies.

*d. Adjust.* To maintain, within prescribed limits, by bringing into proper or exact position, or by setting the operating characteristics to the specified parameters.

*e. Align.* To adjust specified variable elements of an item to bring about optimum or desired performance.

*f. Calibrate.* To determine and cause corrections to be made or to be adjusted on instruments or test measuring and diagnostic equipments used in precision measurement. Consists of comparisons of two instruments, one of which is a certified standard of known accuracy, to detect and adjust any discrepancy in the accuracy of the instrument being compared.

*g. Install.* The act of emplacing, seating, or

fixing into position an item, part, module (component or assembly) in a manner to allow the proper functioning of the equipment or system.

*h. Replace.* The act of substituting a serviceable like type part, subassembly, or module (component or assembly) for an unserviceable counterpart.

*i. Repair.* The application of maintenance services (inspect, test, service, adjust, align, calibrate, replace) or other maintenance actions (welding, grinding, riveting, straightening, facing, remachining, or resurfacing) to restore serviceability to an item by correcting specific damage, fault, malfunction, or failure in a part, subassembly, module (component or assembly), end item, or system.

*j. Overhaul.* That maintenance effort (service/action) necessary to restore an item to a completely serviceable/operational condition as prescribed by maintenance standards (i.e., DMWR) in appropriate technical publications. Overhaul is normally the highest degree of maintenance performed by the Army. Overhaul does not normally return an item to like new condition.

*k. Rebuild.* Consists of those services/actions necessary for the restoration of unserviceable equipment to a like new condition in accordance with original manufacturing standards. Rebuild is the highest degree of materiel maintenance applied to Army equipment. The rebuild operation includes the act of returning to zero those age measurements (hours, miles, etc.) considered in classifying Army equipments/components.

#### B-3. Column Entries

*a. Column 1, Group Number.* Column 1 lists group numbers, the purpose of which is to identify components, assemblies, subassemblies, and modules with the next higher assembly.

*b. Column 2, Component/Assembly.* Column 2 contains the noun names of components, as-

semblies, subassemblies, and modules for which maintenance is authorized.

*c. Column 3, Maintenance Functions.* Column 3 lists the functions to be performed on the item listed in column 2. When items are listed without maintenance functions, it is solely for purpose of having the group numbers in the MAC and RPSTL coincide.

*d. Column 4, Maintenance Category.* Column 4 specifies, by the listing of a "work time" figure in the appropriate subcolumn(s), the lowest level of maintenance authorized to perform the function listed in column 3. This figure represents the active time required to perform that maintenance function at the indicated category of maintenance. If the number or complexity of the tasks within the listed maintenance function vary at different maintenance categories, appropriate "work time" figures will be shown for each category. The number of task-hours specified by the "work time" figure represents the average time required to restore an item (assembly, subassembly, component, module, end item or system) to a serviceable condition under typical field operating conditions. This time includes preparation time, troubleshooting time, and quality assurance/quality control time in addition to the time required to perform the specific tasks identified for the maintenance functions authorized in the maintenance allocation chart. Subcolumns of column 4 are as follows:

- C — Operator/Crew
- O — Organizational
- F — Direct Support
- H — General Support
- D — Depot

*e. Column 5, Tools and Equipment.* Column 5

specifies by code, those common tool sets (not individual tools) and special tools, test, and support equipment required to perform the designated function.

*f. Column 6, Remarks.* Column 6 contains an alphabetic code which leads to the remark in section IV, Remarks, which is pertinent to the item opposite the particular code.

#### **B-4. Tool and Test Equipment Requirements (Sec III)**

*a. Tool or Test Equipment Reference Code.* The numbers in this column coincide with the numbers used in the tools and equipment column of the MAC. The numbers indicate the applicable tool or test equipment for the maintenance functions.

*b. Maintenance Category.* The codes in this column indicate the maintenance category allocated the tool or test equipment.

*c. Nomenclature.* This column lists the noun name and nomenclature of the tools and test equipment required to perform the maintenance functions.

*d. National/NATO Stock Number.* This column lists the National/NATO stock number of the specific tool or test equipment.

*e. Tool Number.* This column lists the manufacturer's part number of the tool followed by the Federal Supply Code for manufacturers (5-digit) in parentheses.

#### **B-5. Remarks (Sec IV)**

*a. Reference Code.* This code refers to the appropriate item in section II, column 6.

*b. Remarks.* This column provides the required explanatory information necessary to clarify items appearing in section II.

SECTION II MAINTENANCE ALLOCATION CHART  
FOR  
MAST, AB-577/GRC AND EXTENSION KIT, MAST MK-806/GRC

(1) GROUP NUMBER	(2) COMPONENT/ASSEMBLY	(3) MAINTENANCE FUNCTION	(4) MAINTENANCE CATEGORY					(5) TOOLS AND EQPT.	(6) REMARKS	
			C	O	F	H	D			
00	MAST AB-577/GRC	Inspect Service Repair Repair Overhaul	0.20 0.20	1.5	1.5			2.5	1 2,3 4 thru 7	A B C D
01	LAUNCHER	Inspect Replace Repair	0.10	1.5	1.5				1 2,3	
0101	BRAKE ASSEMBLY (MALE)	Replace Repair			1.0 1.0				1 2,3	
0102	BRAKE ASSEMBLY (FEMALE)	Replace Repair			1.0 1.0				1 2,3,6	
0103	ELEVATOR ASSEMBLY	Replace Repair			1.0 1.0				1 2,3	
0104	GUIDE ASSEMBLY	Replace Repair			1.5 1.0				1 2,3	
0105	WINCH DRIVE ASSEMBLY	Replace Repair			1.5 1.0				1 2,3	
02	CARRIER ASSEMBLY	Replace Repair		0.5	1.0				1 2,3	
03	ACCESSORY ASSEMBLIES	Repair		0.15						C
04	GUY ASSEMBLIES	Repair		0.15						C
00	EXTENSION KIT, MAST MK-806/GRC	Inspect Service Repair	0.10 0.10	1.5						B C

**SECTION III TOOL AND TEST EQUIPMENT REQUIREMENTS  
FOR  
MAST, AB-577/GRC AND EXTENSION KIT, MAST MK-806/GRC**

TOOL OR TEST EQUIPMENT REF CODE	MAINTENANCE CATEGORY	NOMENCLATURE	NATIONAL/NATO STOCK NUMBER	TOOL NUMBER
1	0	TOOL KIT, ELECTRONIC EQUIPMENT TG-101/G	5180-00-064-5178	
2	F, D	TOOL KIT, ELECTRONIC EQUIPMENT TG-100/G	5180-00-605-0079	
3	F, D	TOOL KIT, ELECTRONIC EQUIPMENT TG-105/G	5180-00-610-8177	
4	D	DYNAMOMETER: DILLON PART NO. AN26996		
5	D	TURNBUCKLE: BREMER-TICNER, TYPE 518X12		
6	D	50-LB SCALE: JOHN CHATILLON & SONS, TYPE 100		
7	D	USAECOM MECHANICAL GAGE NO. 324361		

SECTION IV. REMARKS

REFERENCE CODE	REMARKS
A	PREVENTIVE MAINTENANCE: INSPECT MAJOR ASSEMBLIES, GUYS, GUY ANCHORS, MAST SECTIONS, BASE STAKES, LEVEL.
B	CLEAN.
C	REPAIR BY REPLACEMENT OF MAJOR ASSEMBLIES.
D	ALL REPAIRS.



By Order of the Secretary of the Army:

HAROLD K. JOHNSON,  
General, United States Army,  
Chief of Staff.

Official:

KENNETH G. WICKHAM,  
Major General, United States Army,  
The Adjutant General.

Distribution:

Active Army:

USASA (2)  
CNGB (1)  
CC-E (7)  
Dir of Trans (1)  
CofEngrs (1)  
TSG (1)  
Cof Spts (1)  
USAARENBD (2)  
USAAESWBD (5)  
USARABD (5)  
USACDCEA (1)  
USACDCEC (10)  
USACDCCBRA (1)  
USACDCCEA (1)  
USACDCCEA (Ft Huachuca) (1)  
USACDCOA (1)  
USACDCQMA (1)  
USACDCTA (1)  
USACDCADA (1)  
USACDCARMA (1)  
USACDCAVNA (1)  
USACDCARTYA (1)  
USACDCSWA (1)  
USAMC (5)  
USCONARC (5)  
ARADCOM (5)  
ARADCOM Rgn (2)  
OS Maj Comd (4)  
USARYIS (5)  
USARHAW (5)  
LOGCOMD (2)  
USAMICOM (4)  
USASTRATCOM (4)  
USAESC (70)  
MDW (1)  
Armies (2) except  
    Seventh USA (5)  
    Eighth USA (5)  
Corps (2)  
USAC (3)  
Instl (2) except  
    Ft Hancock (4)  
    Ft Gordon (10)  
    Ft Huachuca (10)  
    WSMR (5)

Ft Knox (12)  
Svc Colleges (2)  
USASESCS (90)  
USAADS (5)  
USAAMS (2)  
USAARMS (5)  
USAIS (2)  
USAES (2)  
USASCS (5)  
USASA Tng Cen & Sch (5)  
USATC Armor (2)  
USATC Engr (2)  
USATC Inf (2)  
USASTC (2)  
Army Dep (2) except  
    LBAD (14)  
    SAAD (30)  
    TOAD (14)  
    LEAD (7)  
    SHAD (3)  
    NAAD (5)  
    SVAD (5)  
    CHAD (3)  
    ATAD (10)  
Gen Dep (2)  
Sig Sec, Gen Dep (5)  
Sig Dep (12)  
AMS (1)  
WRAMC (1)  
Army Pic Cen (2)  
USAERDAA (2)  
USAERDAW (13)  
USACRREL (2)  
MAAG (Vietnam) (5)  
USACA (Taiwan) (5)  
Sig FLDMS (2)  
Units org under fol TOE:—2 ea.  
    11-57  
    11-97  
    11-98  
    11-117  
    11-127  
    11-155  
    11-157  
    11-158

**TM 11-5820-538-12**

11-847  
11-500(AA-AC)  
11-587

11-592  
11-597  
82-56

**NG: State AG (3).**

**USAR: None.**

**For explanation of abbreviations used, see AR 820-50.**



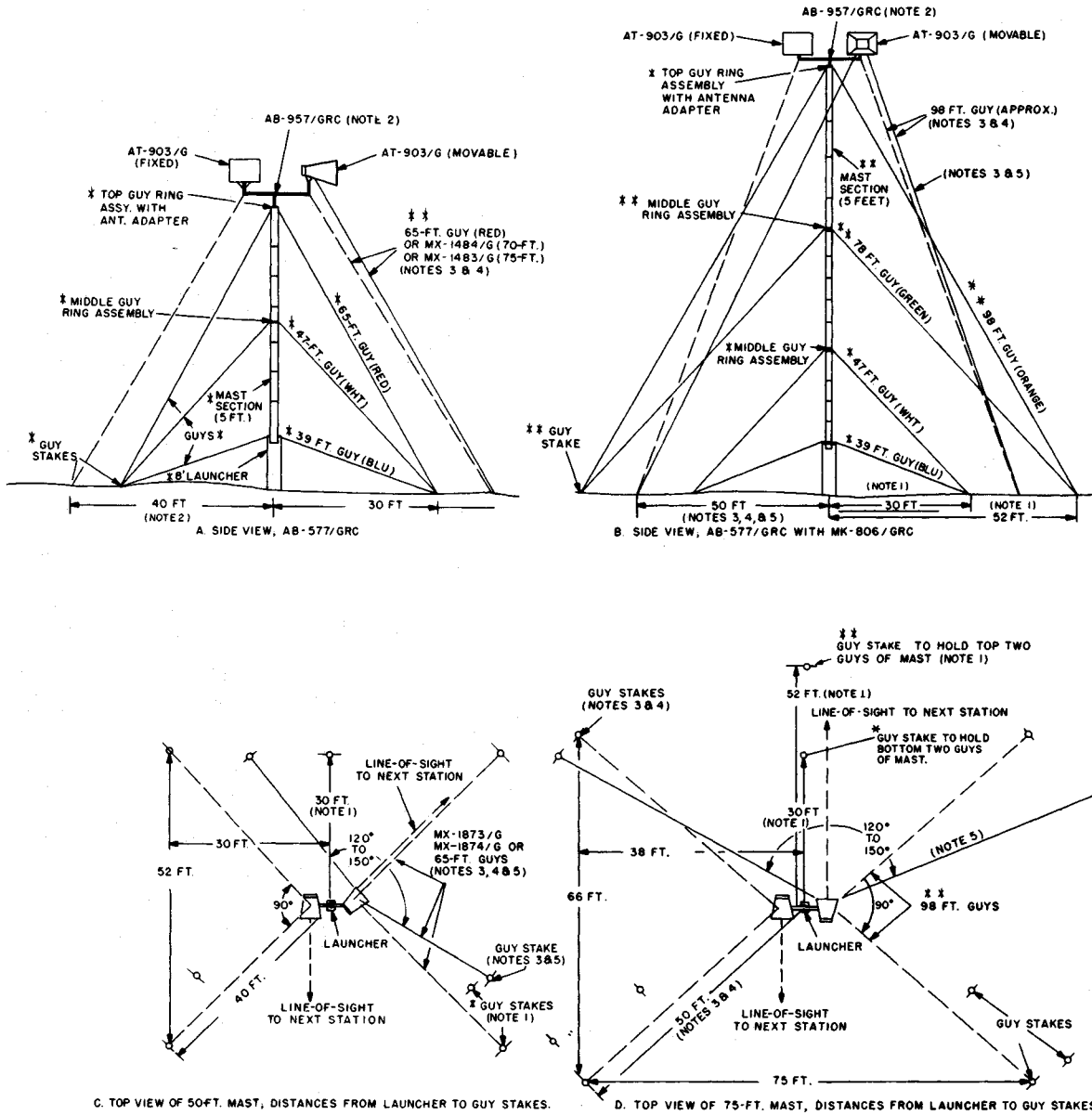

ELBF001

TM 5820-538-15-31

Figure 2-18. Mast erection and guying details.

